

AIRSTREAM®

Roll With The Best®



 SCAN ME

2023 ATLAS

ATLAS™

Owner's Manual



WARNING

Operating, servicing and maintaining a passenger vehicle or off-road vehicle can expose you to chemicals including engine exhaust, carbon monoxide, phthalates, and lead, which are known to the State of California to cause cancer and birth defects or other reproductive harm. To minimize exposure, avoid breathing exhaust, do not idle the engine except as necessary, service your vehicle in a well-ventilated area and wear gloves or wash your hands frequently when servicing your vehicle. For more information go to www.P65Warnings.ca.gov/passenger-vehicle

Disclaimer And Copyright

All information, illustrations and specifications contained in this manual are based on the latest product information available at the time of publication approval. If and when new materials and production techniques are developed that can improve the quality of its product, or material substitutions are necessary due to availability, Airstream reserves the right to make such changes.

Airstream Atlas Owner's Manual

©2022 Airstream, Inc. All rights reserved

Publication Date: November 2022

REV# 03

AIRSTREAM®

TABLE OF CONTENTS

INTRODUCTION	1-1	SPRINTER VAN	7-1
SAFETY	2-1	Important Sprinter Information	7-2
Safety Precautions	2-2	Component Identification	7-2
Chemical Sensitivity and Ventilation	2-2	Tires	7-3
Alarms and Detectors	2-3	Changing A Tire	7-5
Fire Extinguisher	2-9	Installing and Removing A Wheel	7-7
Emergency Exits	2-9	Tire Rotation	7-8
GENERAL INFORMATION	3-1	Air Ride Suspension	7-9
Limited Warranty Policy	3-2	DRIVING	8-1
Service	3-6	Loading	8-2
Camping	3-7	Safety	8-4
FLOOR PLANS AND SPECIFICATIONS	4-1	Trailer Towing and Driving Tips	8-4
Floor Plans	4-2	Towing a Trailer	8-6
Specifications	4-3	Towing Your Touring Coach	8-9
INTERIOR	5-1	Safety Check List	8-9
General Information and Cleaning	5-3	MAINTENANCE	9-1
Electrical	5-9	Maintenance Schedule	9-2
Entertainment Systems	5-18	Suggested Maintenance and Replacement Parts	9-3
Appliances	5-19	Tire Care	9-5
EXTERIOR	6-1	Lithium Iron Phosphate Batteries (House Batteries)	9-6
Waxes and Polishes	6-2	LPG System	9-8
How to Care for Your Touring Coach Finish	6-2	Plumbing	9-10
Roadside Exterior Components	6-4	Drain and Waste System	9-12
Curbside Exterior Components	6-5	Winterizing and Storage	9-14
Exterior Features	6-6	Electrical Diagrams	9-18
Exterior Doors	6-8	Solar Panel Wiring	9-34
Awning	6-10	Multiplex Controls	9-35
Hitch Cover	6-11	Fresh Water Layout	9-37
		FAQs and Answers	9-38

AIRSTREAM®

Section 1 INTRODUCTION

The Owner's Manual for your new Airstream Atlas is designed to respond to the most frequent inquiries regarding the operation, function, and care of the many systems that enhance your travel and camping experience.

The Airstream Atlas is integrated into a Sprinter Van, designed and manufactured by Mercedes-Benz. Operation of the Sprinter, its engine, power train, and other related components are discussed in the Mercedes-Benz Sprinter Operator's Manual and other literature provided by Mercedes-Benz. As a point of reference, those systems discussed in the Sprinter literature are warranted by Mercedes-Benz or their suppliers.

Airstream realizes our customers possess varying degrees of expertise in the area of maintaining and repairing the appliances in their touring coach. For this reason, the service and trouble-shooting information found in this manual is directed toward those with average mechanical skills. We also realize you may be more familiar in one area than you are in another. Only you know your capabilities and limitations.

We want you to use this manual, and hope you will find the information contained in it helpful; however, should you ever feel you may be "getting in over your head," please see your dealer to have the repairs made.

The operation and care of component parts such as, refrigerator, furnace, water heater and others are briefly explained in this manual.

All information, illustrations, and specifications contained in this manual are based on the latest product information available at the time of publication approval. Airstream reserves the right to make changes if and when new materials and/or production techniques are developed that can improve the quality of its product, or when material substitutions are necessary due to availability.

We have provided many important safety messages in this manual. Always read and obey all safety messages.



WARNING

A warning is used for a hazardous situation which, if not avoided, could result in death or serious injury to persons.



CAUTION

A caution is used to advise caution when performing actions that could result in minor or moderate injury to persons and/or damage to equipment.

NOTE

A note is used to address practices not related to personal injury. This applies to hazardous situations involving property damage only.

Optional items may be available on all, or particular models. Additionally, some optional items can only be included during the manufacturing phase and cannot later be added to the touring coach. The inclusion of optional items information in this manual does not imply or suggest the availability, application, suitability, or inclusion for any specific unit.

NOTE

Your Mercedes-Benz Sprinter Van Operator's and Warranty Manuals contain important cautions, warnings, operational, and warranty information on the Sprinter and its components. All information in the Sprinter manual should be reviewed and followed for your safety. The Airstream Owner's Manual may provide additional information and tips on the use of the van as a touring coach; however, no information in the Airstream manual should be interpreted as advice or directions to disregard or void the warnings, cautions, or other information contained in the Sprinter's manuals.

AIRSTREAM®

Section 2 SAFETY

SAFETY PRECAUTIONS	2-2	What Is Carbon Monoxide	2-5
Weight Distribution	2-2	Conditions that can result in potentially dangerous CO situations	2-5
Tire Safety	2-2	Symptoms of Carbon Monoxide Poisoning	2-5
Appliances and Equipment	2-2	Regular Maintenance	2-6
Generator Safety	2-2	Liquid Propane Gas (LPG)/Carbon Monoxide (CO) Detector	2-6
Mold	2-2	Low Voltage	2-6
CHEMICAL SENSITIVITY AND VENTILATION	2-2	Detector Test	2-7
Chemical Sensitivity	2-2	Basic LPG Safety Information	2-7
Formaldehyde	2-3	If you smell gas	2-8
Ventilation	2-3	Basic Generator Safety Information	2-8
Do Not Smoke	2-3	FIRE EXTINGUISHER	2-9
Medical Advice	2-3	EMERGENCY EXITS	2-9
ALARMS AND DETECTORS	2-3	Safety	2-9
Smoke Alarm.	2-4		
Carbon Monoxide Detector	2-4		
This Carbon Monoxide Detector Is Not	2-4		
Important Safety Precautions	2-4		

Safety Precautions

Many things can be construed as safety related, but the most important is your common sense. If you are careless with matches, cigarettes, flammable material, or any other hazardous material, you surely realize your potential for accidents is greatly increased.

You will find many safety recommendations in this section and throughout the manual. The following recommendations are the ones we consider to be the most important.

Weight Distribution

Touring coach's have fresh water and waste water tanks, a water heater, and storage areas. It gives you great flexibility in loading. With flexibility comes responsibility. If you want to load down all the storage compartments, the amount of fluids may have to be reduced. It is a trade off so plan wisely. Distribute your additional cargo as evenly as possible with the heaviest objects located as low as possible.

Do you really want to carry a full fresh water tank to a RV park 1,000 miles away and then hook up to a city water supply? Even if you're going to a remote area, you can usually fill your water tank shortly before entering the area. Just reducing your load by 10 gallons of water lets you carry an additional 83.5 pounds of cargo.

Tire Safety

Properly maintained tires improve the steering, stopping, traction, and load-carrying capability of your vehicle. Refer to Section 9 - Maintenance for tire care and safety information.

Appliances and Equipment

The appliances (stove) and equipment (hot water heater, furnace, etc.) typically operate on liquified petroleum (LP) gas. LP gas is flammable and is contained under high pressure. Improper use may result in a fire and/or explosion. Make sure to follow all instructions and warnings in this manual as well as those in the specific owner's manuals of the appliances and equipment.

Generator Safety

Do not operate the generator in an enclosed building or in a partly enclosed area, such as a garage. Be sure to follow all instructions and warnings in this manual and the generator manufacturer's manual. Refer to Section 5 - Interior for generator information.

Mold

Mold and mold spores exist throughout indoor and outdoor environments. There is no practical way to eliminate all mold and mold spores in the indoor environment; however, the way to control indoor mold growth is to control moisture. Refer to Section 3 - General Information for information on controlling condensation and molds.

Chemical Sensitivity and Ventilation

Chemical Sensitivity

Immediately after the purchase of your new recreational vehicle and sometimes after it has been closed up for an extended period of time, you may notice a strong odor and/or experience a chemical sensitivity. This is not a defect in your recreational vehicle. Like your home, there are many different products used in the construction of recreational vehicles, such as carpet, linoleum, plywood, insulation, upholstery, etc. Formaldehyde is also the by-product of combustion and numerous household products, such as some paints, coatings, and cosmetics. However, recreational vehicles are much smaller than your home and therefore, the exchange of air inside a recreational vehicle is significantly less than in a home. These products, when new or when exposed to elevated temperatures and/or humidity, may off-gas different chemicals, including formaldehyde. This off-gassing, in combination with the minimal air exchange, may cause you to experience irritation of the eyes, nose, and throat, as well as sometimes headache, nausea, and a variety of asthma-like symptoms. Elderly persons and young children, as well as anyone with a history of asthma, allergies, or lung problems, may be more susceptible to the effects of off-gassing.

Formaldehyde

Formaldehyde is a naturally occurring substance and is an important chemical used widely by industries to manufacture building materials and numerous household products. It is also a by-product of combustion and certain other natural processes. Thus, it may be present inside the touring coach. Ventilation of the unit normally reduces the exposure to a comfortable level.

Trace levels of formaldehyde are released from smoking, cooking, use of soaps and detergents, such as carpet shampoos and cosmetics, and many other household products. Some people are very sensitive to formaldehyde while others may not have any reaction to the same levels of formaldehyde. Amounts released decrease over time.

Your Airstream Atlas was manufactured using low formaldehyde-emitting (LFE) wood products, the use of which is typical in the recreation vehicle industry. Formaldehyde has an important role in the adhesives used to bind wood products used in recreation vehicles. The wood products in your coach are designed to emit formaldehyde at or lower than industry guidelines and should not produce symptoms in most individuals.

While LFE wood products typically do not emit formaldehyde at a level that would cause symptoms in most individuals, it is possible, though not likely, for symptoms to occur when the touring coach is not properly ventilated. Ventilation is an essential requirement for touring coach use for many reasons. Any effects of formaldehyde can be greatly reduced by actions such as opening windows, opening roof vents, running the air conditioner, or some combination thereof. In addition, the emission of formaldehyde by these products naturally decreases rapidly over time.

Airstream strongly suggests you take measures to properly ventilate your touring coach on a regular basis. If you have any questions with respect to proper ventilation of your touring coach, please do not hesitate to contact your dealer or Airstream.

Ventilation

To reduce or lessen exposure to chemicals from off-gassing, it is of utmost importance that you ventilate your recreational vehicle. Ventilation should occur frequently after purchase and at times when the temperatures and humidity are elevated. Remember, off-gassing is accelerated by heat and humidity. Open windows, exhaust vents, and doors. Operate ceiling and/or other fans, roof AC, and use a fan to force stale air out and bring fresh air in. Decreasing the flow of air by sealing the recreational vehicle increases the formaldehyde level in the vehicle's indoor air.

Do Not Smoke

It is recommended you do not smoke inside your recreational vehicle. In addition to causing damage to your recreational vehicle, tobacco smoke releases formaldehyde and other toxic chemicals.

Medical Advice

Questions regarding the effects of formaldehyde on your health should be submitted to your doctor or local health department.

Alarms and Detectors

Parts of this section on the combination Smoke/Carbon Monoxide Detector is a reprint of the manual included with the device and provided to you in the Airstream owner's briefcase. Please read, understand, and follow all aspects of the complete manual before activating and operating the Smoke/Carbon Monoxide Detector. If you have not received the manual, contact your dealership to obtain one, or contact Airstream Customer Relations at 937-596-6111.

NOTE

Dangers, Warnings, and Cautions alert you to important operating instructions or to potentially hazardous situations. Pay special attention to these items.

Smoke Alarm

If smoke is detected you will be alerted by 3 beeps, pause, 3 beeps, pause and the detectors LED will flash red as the alarm is sounding. If the alarm does sound exit immediately and call the Fire Department.

The Smoke/Carbon Monoxide Detector will “chirp” once a minute for at least 30 days when the battery is weak. The battery must immediately be replaced with a fresh one.

Carbon Monoxide Detector

If you hear the Carbon Monoxide alarm move everyone to a source of fresh air. When Carbon Monoxide is detected you will be alerted by 4 beeps, pause, 4 beeps, pause and the detectors LED will flash red as the alarm is sounding. If the alarm does sound exit immediately and call the Fire Department. The manual pertaining to the smoke/Carbon Monoxide detector is included in the paperwork given to you at the dealership. Please read and follow all care, maintenance, and safety information contained in the manual.

Carefully read and understand the contents of the provided instruction manual before using the detector. Store the manual in a safe place for future reference. Pay particular attention to the safety warnings. Pass the manual on to any subsequent users of the alarm.



WARNING

Smoke/Carbon Monoxide detectors have a limited life. The unit should be replaced immediately if it is not operating properly. You should always replace an alarm after 5 years from the date of purchase. Write the purchase date on the space provided on the back of unit.



WARNING

This product is intended for use in ordinary, indoor locations of family living units. It is not designed to measure compliance with occupational safety and health administration (OSHA) commercial or industrial standards. Individuals who are at special risk from Carbon Monoxide exposure by reason of age, pregnancy, or medical condition may consider using warning devices which provide audible and visual signals for Carbon Monoxide concentration under 30 ppm. If in doubt, consult your medical practitioner.

This Carbon Monoxide Detector Is Not

- Designed to detect any gas other than Carbon Monoxide.
- To be seen as a substitute for the proper servicing of fuel-burning appliances.
- To be used on an intermittent basis, or as a portable alarm for spillage of combustion products from fuel-burning appliances.

NOTE

This Carbon Monoxide detector is designed for indoor use only. Do not expose to rain or moisture. Do not knock or drop the alarm. Do not open or tamper with the alarm as this could cause a malfunction. The detector will not protect against the risk of Carbon Monoxide poisoning when the batteries are dead or missing. The alarm will only indicate the presence of Carbon Monoxide gas at the sensor. Carbon Monoxide gas may be present in other areas.

Important Safety Precautions

- Ideally, it is recommended that a Carbon Monoxide detector should be installed in or near every room that has a fuel burning appliance such as any room heaters, water heaters, cookers, grills, etc.
- Ensure that the alarm horn can be heard by all those who are intended to hear it. Seek medical help if it is suspected that a user of the RV is suffering from Carbon Monoxide poisoning.
- If the alarm sounds, make sure to investigate the problem. Ignoring the alarm may result in sickness, injury or death. (CO may be present even if nothing is seen or smelled by the user.)
- Room spaces should be well ventilated when household cleaning supplies are used as these may cause a false alarm.
- Alarm should be tested once per week. If further details are required, which do not appear in this manual, contact BRK Brands Inc. First Alert.



WARNING

Activation of your Carbon Monoxide detectors audible horn indicates the presence of Carbon Monoxide that can kill you. Leave the area immediately!

What Is Carbon Monoxide

Carbon Monoxide (CO) is a highly poisonous gas that is released when fuels are burned. It is invisible, has no smell, and is therefore very difficult to detect with the human senses. Under normal conditions, in a room where fuel-burning appliances are well maintained and correctly ventilated, the amount of CO released into the room by appliances is not dangerous.

These fuels include wood, coal, charcoal, oil, natural gas, gasoline, kerosene, and propane. Common appliances are often sources of CO. If they are not properly maintained, are improperly ventilated, or malfunction, CO levels can rise quickly. CO is a real danger in air-tight vehicles with added insulation, sealed windows, and other weatherproofing that can trap CO inside.

Conditions that can result in potentially dangerous CO situations

1. Excessive spillage or reverse-venting of fuel-burning appliances caused by outdoor conditions, such as:
 - Wind direction and/or velocity, including high gusts of wind.
 - Heavy air in the vent pipes (cold/humid air with extended periods between cycles).
 - Negative pressure differential resulting from use of exhaust fans.
 - Simultaneous operation of several fuel-burning appliances competing for limited internal air.
 - Vent-pipe connections vibrating loose from clothes dryers, furnaces, or water heaters.
 - Obstructions in or unconventional vent-pipe designs which can amplify the above situations.
2. Extended use of un-vented fuel burning devices.
3. Temperature increase that can trap exhaust gases near the ground.

Symptoms of Carbon Monoxide Poisoning

- Mild Exposure - Slight headache, nausea, vomiting, fatigue (flu-like symptoms).
- Medium Exposure - Throbbing headache, drowsiness, confusion, fast heart rate.
- Extreme Exposure - Convulsions, unconsciousness, heart and lung failure. Exposure to CO can cause brain damage and/or death.



WARNING

The Smoke/CO detector is shipped with batteries deactivated. Ask your dealer to activate batteries or activate batteries immediately upon delivery. Failure to follow this warning will remove your protection.



WARNING

Many causes of reported CARBON MONOXIDE POISONING indicate that while victims are aware that they are not well, they become so disoriented that they are unable to save themselves by either exiting the area or calling for assistance. Also young children and pets may be the first to be affected.



WARNING

Test units in your touring coach after the vehicle has been in storage, before each trip, and at least once a week while in use. If the alarm ever fails to test correctly, have it replaced immediately. If the alarm is not working properly, it cannot alert you to a problem. Failure to test units used in RVs as described may remove your protection.

Regular Maintenance

The Smoke/CO detector has been designed to be as maintenance-free as possible, but there are a few simple things you must do to keep it working properly. Use only listed replacement batteries. The unit may not operate properly with other batteries. Never use rechargeable batteries since they may not provide a constant charge.

- Test it at least once a week.
- Clean the Smoke/CO Alarm at least once a month: gently vacuum the outside of the alarm using your household vacuum's soft brush attachment. A can of clean, compressed air (sold at computer or office supply stores) may also be used. Follow manufacturer instructions for use. Never use water, cleaners, or solvents, since they may damage the unit.
- If the alarm becomes contaminated by excessive dirt, dust, and/or grime, and cannot be cleaned to avoid unwanted alarms, replace the unit immediately.



WARNING

The battery door will resist closing unless batteries are installed. This warns you that the unit will not operate without batteries.



WARNING

Carbon Monoxide is poisonous and can cause confusion, unconsciousness, and death. Follow all instructions, cautions, and warnings in this section and the generator operator's manual.



WARNING

NEVER ignore any alarm. Failure to respond can result in injury or death. The Silence Features are for your convenience only and will not correct a problem. Always check your touring coach for a potential problem after any alarm. Failure to do so can result in injury or death.

Liquid Propane Gas (LPG)/Carbon Monoxide (CO) Detector



This detector has a five-year life; see end-of-life notification in the detectors manual. Please read the entire detector manual before operating the unit.

The LPG/CO detector is located in the galley area. LPG is a mixture of gases produced and sold commercially as a fuel for heating and cooking appliances. LPG is highly flammable and, as a result, can be explosive if ignited under certain circumstances. LPG is heavier than air and, if confined in a closed space, will accumulate close to the floor. The LPG/CO detector is designed to alarm when propane gas exceeds 10% of the lower-explosive-limit for more than 30 seconds or if CO gas reaches unsafe levels. When propane gas is detected the horn will sound with constant beeps and the red LED will be on. If CO gas is detected the horn will sound with 4 rapid chirps followed by a 4 second pause and the red LED will flash rapidly.

Your LPG/CO detector is wired directly to your touring coach battery and incorporates a 1-amp, in-line fuse. It has no internal battery backup. In normal stand-by mode, the LED indicator will be green.

Low Voltage

The operating voltage for the detector is 12 VDC. The actual voltage supplied to the detector in a recreational vehicle may drop below the minimum 8 VDC. The detector provides the user with a low voltage warning before reaching that level and will provide additional distinct, clear warnings and alarms after the 8 VDC level is reached. However, if available power supplied to the unit is below the operating voltage of 8 VDC, the detector will not detect gas or provide protection against dangerous levels of LPG.

NOTE

If the low voltage warning sounds, the detector will need to be reset by disconnecting the battery, before normal operation will occur.

Detector Test

If the Silence/Test button is pressed while in normal operation, the alarm will perform a self test of the CO sensor, propane sensor and battery voltage. It is recommended to perform a self test weekly, after power up from storage, and before each trip. If the self test passes, the alarm will perform 2 cycles of the CO horn pattern (4 rapid chirps followed by a 4 second pause), followed by 2 cycles of the propane horn pattern (constantly beeping).



WARNING

Activation of this detector indicates the possible presence of LPG, which can cause an explosion and/or fire, causing serious injury or death. This normally indicates a leak in the LPG installation or an LPG appliance. Extinguish all open flames, open your windows and door, and evacuate the unit immediately. Do not activate any electrical switch. Turn off the LPG using the remote shut off switch.

Do not re-enter your unit until a qualified repair technician has corrected the problem and certified the system as safe.



WARNING

It is not recommended that the detector be disconnected from the battery during periods of storage. There is a small heater on the sensor of the device that burns away impurities in the air during periods of normal use. During periods when power is interrupted, impurities can build up on the sensor. When power is returned to the detector, the detector alarm may activate until the impurities are burned off. This could take a number of hours, during which time the alarm will be constantly on.



WARNING

Have a qualified technician check your LPG system annually or if you detect any signs of leaks or malfunctions.

NOTE

Refer to Section 5 - Interior and Section 6 - Exterior for additional LPG warnings and safety information.

Basic LPG Safety Information

A warning label has been positioned in the cooking area to remind you to provide an adequate supply of fresh air for combustion. Unlike homes, the amount of oxygen supply is limited due to the size of the recreational vehicle, and proper ventilation when using the cooking appliances will avoid dangers of asphyxiation. It is especially important that cooking appliances not be used for comfort heating as the danger of asphyxiation is greater when the appliance is used for long periods of time.

Portable fuel burning equipment, including wood and charcoal grills and stoves, shall not be used inside the recreational vehicle. The use of this equipment inside the recreational vehicle may cause fires or asphyxiation.

A Warning Label has been located near the LP gas container. This label reads: DO NOT FILL CONTAINER(S) TO MORE THAN 80% PERCENT OF CAPACITY. Overfilling the LP gas container can result in uncontrolled gas flow that can cause a fire or explosion. A properly filled container will contain approximately 80 percent of its volume as liquid LP gas.



WARNING

DO NOT store LP containers within vehicle. LP containers are equipped with safety devices that vent gas should the pressure become excessive.



WARNING

DO NOT use cooking appliances for comfort heating. Cooking appliances need fresh air for safe operation. Before operation, open overhead vent or turn on exhaust fan and open window.

If you smell gas

- Extinguish any open flames, pilot lights and all smoking materials.
- Do not touch electrical switches.
- Shut off the gas supply using the remote shut off switch.
- Open doors and other ventilating openings.
- Leave the area until odor clears.
- Have the gas system checked and leakage source corrected before using again.

LP gas regulators must always be installed with the diaphragm vent facing downward. Regulators that are not in compartments have been equipped with a protective cover. Make sure that regulator vent faces downward and that cover is kept in place to minimize vent blockage that could result in excessive gas pressure causing a fire or explosion.

The regulator at the LP tank is under a gray, plastic cover. The protective cover helps to keep the vent on the regulator from being clogged by wasps or ice, but the regulator should be checked regularly to make sure the vent remains clear.



WARNING

Do not attempt to seal regulator cover.



WARNING

Check vent each time tank is filled to make sure it is clear of obstructions.



WARNING

Have a qualified technician check your LP Gas system annually or if you have any signs of leaks or malfunctions.

Basic Generator Safety Information

1. Never sleep in the vehicle with the generator running without ensuring the Carbon Monoxide detector is working. Primary protection against inhaling Carbon Monoxide is daily (every eight hour) inspection for visible and audible generator exhaust system leaks.
2. DO NOT operate the generator in an enclosed building or in a partly enclosed area such as a garage.
3. Review the safety precautions for fuel and exhaust fumes in the generator manual.
4. DO NOT operate the generator when the recreation vehicle is parked in high grass or brush. Heat from the exhaust could cause a fire in dry conditions.
5. DO NOT simultaneously operate generator and a ventilator which could result in the entry of exhaust gas. When exhaust ventilators are used, we recommend that a window on the opposite side of the unit “upwind” of exhaust gases be opened to provide cross ventilation.
6. When parked, orient the vehicle so that the wind will carry the exhaust away from the vehicle. DO NOT open nearby windows, ventilators, or doors into the passenger compartment, particularly those which can be “down wind”, even part of the time.
7. DO NOT operate the generator when parked in close proximity to vegetation, snow, buildings, vehicles, or any other object that could deflect the exhaust under or into the vehicle.
8. DO NOT touch the generator when running, or immediately after shutting off. Heat from the generator can cause burns. Allow the generator to cool before attempting maintenance or service.



WARNING

Your touring coach is equipped with an Automatic Generator Start System. Exposure to carbon monoxide, moving parts, and electricity hazards are possible due to unexpected automatic starting.

NOTE

The generator is located in the exterior curbside rear compartment of the touring coach.

Fire Extinguisher



The fire extinguisher should be checked for charge on a regular basis. Make sure your family knows how to release the extinguisher storage bracket and how to properly operate the extinguisher. Check with your local fire department for professional advice on its operation and use if you find the directions on the extinguisher unclear. They will be able and willing to assist you and your family.



WARNING

Read the directions carefully on the fire extinguisher. If there is any doubt on the operation you and your family should practice, then replace or recharge the extinguisher. You will find your local fire department will be happy to assist you and answer any questions.



WARNING

Do not smoke inside the touring coach. Keep matches out of reach of small children. Do not clean with flammable material. Keep flammable material away from open flame. We have all heard these warnings many times, but they are still among the leading causes of fires.

Emergency Exits

There are three avenues of escape from the touring coach in the event of an emergency, the driver's door, the passenger door, and the side entry door. As always, safety should be one of your top priorities. Make sure you and everyone traveling with you can operate these doors and exit rapidly without light. A little planning and a quick practice session at each camping site is well worth the time it may take. Remember the side entry door steps take a few seconds to extend once the door is opened. If power is unavailable the step may not extend at all. Always look before exiting the side entry door.

Safety

As always, safety should be a top priority. Ensure that you, and everyone traveling with you, can quickly operate the main door in the dark. Plan for other means of escape in case the designated exit is blocked.



WARNING

At each campsite, make sure you have not parked in such a manner as to block the operation of the doors or the escape avenues by being too close to trees, fences, or other impediments. Scenic views are one reason for traveling, but do not park so the beautiful lake or steep cliff is just outside your doors. Do not block access to the doors from the inside or outside of the vehicle.

AIRSTREAM®

Section 3 GENERAL INFORMATION

LIMITED WARRANTY POLICY	3-2	CAMPING	3-7
This Limited Warranty Covers	3-2	Suggested Pre-Travel Check List	3-7
Coverage Ends	3-2	Exterior	3-7
Limitation Of Implied Warranties	3-2	Interior	3-7
Disclaimer Of Incidental And Consequential Damages	3-2	Touring Coach Equipment and Accessories	3-7
Repair Remedy	3-2	Motoring Essentials	3-7
Back-Up Remedy	3-3	Overnight Stop	3-7
What Is Not Covered	3-3	Overnight or Weekend Trips	3-8
Obtaining Warranty Service	3-4	Longer Trips	3-8
Consumer Arbitration Program	3-5	Extended Stay	3-8
Events That Discharge Airstream's Obligations Under This Limited Warranty	3-5	Leveling	3-8
Legal Remedies	3-5	Effects of Prolonged Occupancy	3-9
Airstream Limited Warranty Excludes	3-5	About Molds	3-10
Normal Wear	3-5	What are molds	3-10
Accident	3-5	What factors contribute to mold growth	3-10
Abuse	3-5	How can mold growth be inhibited	3-10
Exposure	3-5	Waste Water System.	3-10
Overload	3-5	Things Not to Put into Toilet or Drains	3-10
Chemical Gassing	3-5	Drain System	3-10
Sprinter Van	3-6	Winter Traveling	3-11
SERVICE	3-6	Heated Tanks	3-11
Reporting Safety Defects	3-6		

Limited Warranty Policy

This Limited Warranty Covers

(i) The first retail owner and any subsequent owners
(ii) ONLY those portions of a NEW motorhome not excluded under the section “What is Not Covered”, when sold by an authorized dealership and used for its intended purpose of recreational travel and camping; and, (iii) ONLY defects in workmanship performed and/or materials used to assemble those portions of your motorhome not excluded under the section “What is Not Covered”. “Defect” means the failure of the workmanship performed and/or materials used to conform with the design and manufacturing specification and tolerances of Airstream. The Limited Warranty is transferable and the subsequent owner’s warranty coverage period shall be the unexpired balance of the original warranty coverage period. A completed copy of the Warranty Transfer Form must be submitted to Airstream at the time of resale.

When you request and accept the performance of warranty repairs under the terms of this Limited Warranty, you are accepting all terms of this Limited Warranty, including by way of example, warranty limitations and disclaimers, the forum selection clause and the clause reducing the time period when suit must be filed for breach.

If any term of condition in this limited warranty conflicts with your state’s Uniform Commercial Code (“UCC”) as interpreted by courts within your state, the provisions of your state’s UCC are varied as allowed for by USS 1-302.

Coverage Ends

36 months after the first retail owner first takes delivery of the motorhome from an authorized dealership or after the odometer reaches 36,000 miles, whichever occurs first. Any action for breach of this warranty or any implied warranties must be commenced not more than 37 months after breach. Some states do not allow the reduction of the time when a breach of warranty claim must be commenced, so the reduction in time when a breach of warranty claim must be commenced may not apply to you.

Limitation Of Implied Warranties

Implied warranties arising under applicable law, if any, including but not limited to implied warranties of merchantability or fitness for a particular purpose, are hereby limited in duration to the term of this limited warranty and are limited in scope of coverage to those portions of the motorhome covered by this limited warranty. There are no express warranties or any implied warranties of merchantability on those portions of the motorhome excluded from coverage. There is no warranty of any nature made by airstream beyond that contained in this limited warranty. No person has authority to enlarge, amend or modify this limited warranty. The dealer is not Airstream’s agent. Airstream is not responsible for any undertaking, representation or warranty made by any dealer or others beyond those expressly set forth within this limited warranty. Some states do not allow limitations on how long an implied warranty lasts, so the above limitations may not apply to you.

Disclaimer Of Incidental And Consequential Damages

Airstream disclaims any and all incidental and consequential damages, including but not limited to expenses such as transportation to and from dealerships and Airstream repair facilities, loss of time, loss of pay, loss of use, inconvenience, commercial loss (including but not limited to lost profits), towing charges, bus fares, vehicle rental, service call charges, gasoline expenses, incidental charges such as telephone calls and facsimile transmissions, and expenses for lodging and moisture damage such as mold and mildew as well as rust and corrosion. This disclaimer is independent of any failure of the essential purpose of any warranties provided with the motorhome, and shall survive any determination that a warranty failed of its essential purpose. Some states do not allow the exclusion or limitation of incidental or consequential damages, so the above limitation or exclusion may not apply to you.

Repair Remedy

Airstream’s sole and exclusive obligation is to repair any covered defects discovered within the warranty coverage period if: (1) within 10 days of your discovery of a defect you notify Airstream OR an authorized dealership of the defect; AND (2) you deliver your Motorhome to Airstream OR an authorized dealership at your cost and expense.

Back-Up Remedy

If the primary repair remedy fails to successfully cure any defect after a reasonable number of repair attempts, your sole and exclusive remedy shall be to have Airstream pay an independent service shop of your choice to perform repairs to the defect OR if the defect is incurable, have Airstream pay diminution in value damages. The repair remedy and the back-up remedy must both be exhausted and these remedies must fail to fulfill their essential purpose before you can seek other legal or equitable remedies for breach of this express warranty or for breach of any implied warranty. This limited warranty is not a warranty that promises or extends to future performance because the warranty does not make a representation on how your motorhome will perform in the future but instead represents only what the remedy will be if a defect exists.

Unless prohibited by state law, repairs will not extend the time when you must commence a breach of warranty claim and shall not extend the warranty coverage period. Any performance of repairs after the warranty coverage ends OR any performance of repairs to those portions of your motorhome excluded from coverage shall be considered "good will" repairs. Warranty repairs should be expected. Airstream may use new and/or remanufactured parts and/or components of substantially equal quality to complete a repair. Damage to interior or exterior surfaces, trim, upholstery and other appearance items may occur at the factory during assembly, during delivery of the motorhome to your selling dealer or on the selling dealer's lot. Normally, any damage is detected and corrected at the factory or by the selling dealer during the inspection process. If you discover any damage when you take delivery of your motorhome, you MUST notify your dealer OR Airstream within 10 days of the date of purchase to have damage repaired at no cost to you. Minor adjustments, such as adjustments to the interior or exterior doors, drawers, latches will be performed at no cost to you by your selling dealer during the first 90 days of warranty coverage; thereafter, such adjustments are your exclusive responsibility as normal maintenance.

What Is Not Covered

1. Tires, batteries, lithium power systems, stereo, television, range/stove, furnace, refrigerator, air conditioner, toilet, water heater, microwave, generator, glass breakage, and other materials, parts and components warranted by persons or entities other than Airstream. Please refer to the warranties of component manufacturers for terms and conditions of coverage;
2. Accessories and equipment that are working as designed, but which you are unhappy because of the design
3. Any part or component of the vehicle that was not manufactured or installed by Airstream;
4. Normal deterioration due to wear or exposure, including but not limited to upholstery, flooring rust, corrosion, oxidation, and cosmetic blemishes;
5. Normal maintenance and service items, including but not limited to light bulbs, fuses, lubricants, sealants and seals, door adjustments, and awning tension;
6. After-market equipment or accessories installed on the vehicle after completion of manufacture by Airstream, or any defects or damage caused by such items;
7. Vehicles not purchased through an authorized dealer of Airstream and vehicles purchased directly or indirectly through auction, salvage, repossession, or other non-customary sale means;
8. Any motorhome used other than for temporary recreation purposes, including, but not limited to, use of the motorhome for residential, rental, business and commercial purpose or any motorhome purchased by, registered by, or titled in the name of a business association (such as any LLC, corporation, or partnership). If the motorhome owner or user files a tax form claiming a business or commercial tax benefit or income related to the motorhome, it shall be irrefutable that the motorhome has been used for rental, commercial or business purposes..

General Information

9. Defects or damage caused by, in whole or in part, or in any way related to: Accidents, misuse (including off-road use), or negligence; Failure to comply with the instructions set forth in any owner's manual provided with the vehicle; Alteration or modification of the vehicle except such alterations or modifications approved in writing by Airstream; Acts of God or other environmental conditions, such as lightning, hail, salt causing rust, or other chemicals in the atmosphere; De-icing agents or other chemicals applied to the vehicle; Failure to properly maintain or service the vehicle, including but not limited to the maintenance of lubricants, sealants, and seals; Condensation and the results of condensation including water damage and the growth of mold or mildew. Mold and mildew are natural growths given certain environmental conditions and are not covered by the terms of this Limited Warranty; The addition of weight to the vehicle that causes the total weight to exceed applicable vehicle weight ratings, or addition of weight causing improper distribution of the weight of the vehicle; Failure to seek and obtain repairs in a timely manner; Failure to use reasonable efforts to mitigate damage caused by defects' Failure to properly ventilate the vehicle; Improper electric power supply or improper vehicle hookup to other facilities; and, Acts or omissions of any person or entity other than Airstream. (Note: An irrefutable presumption arises that the motorhome has been used for commercial and/or business purposes if the motorhome owner or user files a tax form claiming any business or commercial tax benefit related to the motorhome, or if the motorhome is purchased, registered or titled in a business name.)

Obtaining Warranty Service

In order to obtain warranty service under this Limited Warranty, the owner must do all of the following:

1. Owner and dealer representative must complete and return the Customer Performance Checkout within 10 days from delivery of the vehicle,
2. Notify Airstream or one of its authorized, independent dealers of any claimed defect within the warranty period or 10 days thereafter,
3. Provide notification of a defect within 10 days of discovery of that defect, and
4. Promptly return the motorhome to an authorized Airstream dealer or Airstream for repairs.

If you believe a defect covered by this Limited Warranty still exists after an attempted repair by an authorized Airstream dealer, you must contact Airstream in one of the following manners, and specify:

1. The complete serial number of the vehicle,
2. The date of original purchase and the date of original delivery,
3. The name of the selling dealer, and
4. The nature of the problem and the steps or service which have been performed.

Email: support@airstream.com

Phone: (937) 596-6111

Mail: AIRSTREAM, INC., 428 West Pike Street, P.O. Box 629, Jackson Center, Ohio 45334-0629, Attention: Owner Relations Department

Airstream may direct you to an authorized Airstream dealer, or may request that you bring your motorhome to the Airstream factory in Jackson Center, Ohio for repairs.

Airstream does not control the scheduling of repairs at its authorized Airstream dealers, and repairs at the Airstream factory may not be immediately available. Therefore, you may encounter delays in scheduling repairs and/or completion of repairs. All costs associated with transporting the motorhome for any warranty service shall be the sole responsibility of the owner.

Consumer Arbitration Program

For recreation vehicles purchased in the State of California, Airstream, Inc. participates in the Consumer Arbitration Program for Recreation Vehicles (CAP-RV). This third-party dispute resolution program is available, at no charge to you, to settle unresolved warranty disputes for recreation vehicles. This dispute resolution program reviews eligible product and service related complaints involving warranty covered components. To find out more about this program, or to request an application/brochure, please call the Arbitration Administration office toll-free 800.279.5343. The CAP-RV program operates as a certified mechanism under the review of the California Arbitration Certification Program. Members of the armed forces who purchased the vehicle in California, or who were stationed in or a resident of California at the time of purchase (regardless of state of purchase) or who are stationed in California at the time of application to this program may utilize the CAP-RV program.

Events That Discharge Airstream's Obligations Under This Limited Warranty

Misuse or neglect, accidents, unauthorized alteration, failure to provide reasonable and necessary maintenance (see Owner's Manual), damage caused by off road use, collision, fire, theft, vandalism, explosions, overloading in excess of rated capacities, odometer tampering, and use of the motorhome for commercial, business, or rental purposes shall discharge Airstream from any express or implied warranty obligation to repair any resulting defect.

Legal Remedies

Exclusive jurisdiction for deciding legal disputes relating to alleged breach of express warranty and breach of implied warranties arising by operation of law as well as those relating to representations of any nature rests in the courts within the state of manufacture, which is Ohio. Also, this limited warranty shall be interpreted and construed in accordance with the laws of the state of Ohio. Any and all claims, controversies, and causes of action arising out of or relating to this limited warranty, whether sounding contract, tort or statute, shall be governed by the laws of the state of Ohio, including its statute of limitations, without giving effect to any conflict of law rule that would result in the application of the laws of a different jurisdiction.

Airstream Limited Warranty Excludes

Normal Wear

Items such as curtains, upholstery, floor coverings, and window, door, and vent seals will show wear or may even wear out within the 3-year warranty period, depending upon the amount of usage, weather, and atmospheric conditions.

Accident

We strongly urge our dealers and customers to inspect the touring coach upon receipt of delivery for any damage caused by accident while being delivered to the dealer, or while it is on the dealer's lot. Damage of this nature becomes the dealer or customer's responsibility upon acceptance of delivery, unless Airstream is notified and the person making the delivery verifies the damage. Glass breakage, whether obviously struck or mysterious, is always accidental and covered by most insurance policies.

Abuse

Lack of customer care and/or improper maintenance will result in early failure for which Airstream cannot be held responsible.

Exposure

Deterioration by sunlight is possible to such items as tires, curtains or upholstery. Steel or metal surfaces are subject to the elements, causing rust and corrosion that is normal and beyond the control and responsibility of Airstream.

Overload

Overload Damage due to loading beyond capacity or to cause improper balance is not covered by the Airstream Limited Warranty. The Airstream Touring Coach is engineered to properly handle any normal load. There are limits to the amount of load that can be safely transported depending upon speed and road conditions. If these limits have been exceeded, the Airstream Limited Warranty will not cover resulting damage. For additional information on the load capacity of your touring coach, consult your Sprinter and Airstream Owner's Manuals or gross vehicle weight rating plate.

Chemical Gassing

Chemical gassing is not a "Defect" in your recreational vehicle and is not covered by the Limited Warranty. Please follow the recommendations in this manual to address this concern.

General Information

Sprinter Van

Airstream, Inc., does not accept any responsibility in connection with any of its touring coach's for the Sprinter Van or its components. The Sprinter Van and its components are covered by Mercedes-Benz Warranties as explained by Sprinter literature provided. Your Sprinter Van and its components are pre-checked by its manufacturer before delivery to Airstream. All service to the Sprinter Van and its components must be performed by Mercedes-Benz Sprinter designated service points according to the manufacturer's warranty and service policies. The literature provided with each touring coach gives important information concerning its warranty coverage, maintenance, and operation.

The Airstream Atlas Owner's Manual may provide additional information and tips on the use of the van as a touring coach, however, no information, in whole or in part, in any Airstream manual should be interpreted as advice or directions to disregard or void the Warnings, Cautions, Notices, or other information contained in the Sprinter's manuals.



WARNING

Your Mercedes-Benz Sprinter Van Operator's and Warranty Manuals contain important cautions, warnings, operational, and warranty information on the Sprinter and its components. All information in the Sprinter manual should be reviewed and followed for your safety.

Service

Before leaving the factory, every vital part of the touring coach is tested for performance. Each test is signed and certified by an inspector. After the touring coach arrives on your dealer's lot, all vital parts and systems are again tested. When you take delivery of your new touring coach, you will receive a complete check out.

At that time, a specified list of performance checks on your touring coach equipment will be conducted, and any deficiencies you have experienced since taking delivery will be corrected.

Please contact your dealer if your touring coach needs service. Major service under your Airstream Limited Warranty is available through our nationwide network of Airstream Dealer Service Centers. To find a dealer, please visit, www.Airstream.com to use our dealer locator.

Occasionally, dealerships change, or new dealers are added that may not appear on the website immediately. Please note that all centers operate on an appointment basis for the utmost efficiency.

When you require service for your touring coach from the Airstream Factory Service Center or a Certified Dealer Service Center, please contact the service manager for an appointment, and inform them if you are unable to keep the appointment date or wish to change it. Service may be arranged at the Factory Service Center by contacting the Service Coordinator at:

Airstream Factory Service Center

428 West Pike Street

P.O. Box 629

Jackson Center, Ohio 45334-0629

Phone: (937) 596-6111 or (877) 596-6111

NOTE

Connected RV features and systems may be turned off while in a service facility for the safety of our technicians. You might have to re-pair your personal device after service appointment.

Reporting Safety Defects

If you believe your vehicle has a defect which could cause a crash or could cause injury or death, you should immediately inform the National Highway Traffic Safety Administration (NHTSA), in addition to notifying Airstream, Inc.

If NHTSA receives similar complaints, it may open an investigation, and if it finds that a safety defect exists in a group of vehicles, it may order a recall and remedy campaign. However, NHTSA cannot become involved in individual problems between you, your dealer, or Airstream Inc.

To contact NHTSA, you may either call the Vehicle Safety Hotline toll-free at 1-888-327-4236 (TTY: 1-800-424-9153), go to <http://www.safercar.gov>, or write to:

Administrator

NHTSA

1200 New Jersey Avenue, S.E.

Washington, DC 20590

You can also obtain other information about motor vehicle safety from <http://www.safercar.gov>.

Camping

Suggested Pre-Travel Check List

Exterior

1. Verify power cord is stored.
2. Verify water and sewer hoses are stored.
3. Double check all hitch connections (if towing).
4. Look under, over, and around the vehicle for any overlooked items.
5. Ensure all exterior compartments are closed and latched.
6. Check exterior lighting.
7. Check torque of lug nuts.
8. Check tires for correct pressure.

Interior

1. Turn off water pump, water heater, and furnace.
2. Close windows and vents.
3. Close all interior cabinet doors.
4. Latch refrigerator door. (Seal containers first.)
5. Secure, stow, and latch for travel anything that will move, fall, or open.
6. Drain toilet bowl.
7. Turn off 12-volt lights.

Touring Coach Equipment and Accessories

1. Water hose, 5/8-in. high-pressure, tasteless, odorless, non-toxic (two 25-ft. sections).
2. Y connection - water hose.
3. Holding tank cleaner and deodorizer.
4. Power cord adapter, 30-amp capacity.
5. 30-ft. electric cord, 30-amp capacity.
6. Wheel chocks.
7. Torque wrench.
8. Quality tire gauge.
9. Verify emergency light and first aid kits.

Motoring Essentials

1. Touring coach registration.
2. Carry driver's license.
3. In Canada, bring along a non-residence liability insurance card and your passport.
4. In Mexico, you must have special auto insurance.
5. Carry an extra set of the ignition keys in a separate pocket or in your wallet.
6. Keep an operating flashlight with fresh batteries in the glove compartment.
7. Pack so that you can reach tools without completely unpacking.
8. Carry your pet's dish, food, leash, and health and registration papers.

Overnight Stop

In time you will develop a knack for spotting wonderful little roadside locations by turning off the main highway and exploring. There are many modern recreational vehicle parks, including State, County, and Federal parks with good facilities, where you may obtain electrical, water, and sewer hookups and connections. Directories are published which describe in detail these parks and tell what is available in the way of services and hookups.

All you need to do to enjoy the self-contained luxury while boondocking is to:

1. Turn on the 12-volt battery disconnect switch to provide power to your components.
2. Turn on the exterior LP gas supply, if you need to cook or start the generator.
 - Generator must be started to run the air conditioner.
 - Inverter will need to be turned on to power the entertainment devices. To conserve battery power, turn off the inverter when not in use.
3. Turn on the water pump and open faucets until air is expelled from the system.

Before moving on, turn off the LP gas and water pump. Check your campsite, both for cleanliness and to be sure you have not left anything behind. Make sure everything is properly stowed.

General Information

Overnight or Weekend Trips

On overnight or weekend trips, chances are you will not use up the capacity of the holding tanks. Deplete the water supply, if using the system moderately or conservatively. You will need to maintain the level of your battery during this time. The batteries will shut down at 10.5 volts. It is recommended you charge the batteries, by plugging into shore power or by starting your generator, when they reach 12 volts.

Longer Trips

On a longer trip, when you have stayed where sewer connections and utility hookups were not available, it will be necessary for you to stop from time to time to dispose of the waste in the holding tank and replenish the water supply. Many truck stops and gas stations, chain and individually owned, have installed sanitary dumping stations for just this purpose. Booklets are available that list these facilities.

When you stop for the night, your Airstream Touring Coach is built to be safely parked in any spot that is relatively level and where the ground is firm. Your facilities are with you. You are self-contained. Try to pick as level a parking spot as possible.

Extended Stay

Making a long trip is not very different from making a weekend excursion. Since everything you need is right at hand, you are at home wherever you go. When packing for an extended trip, take everything you need, but only what you need.

Hook up to water by attaching a ½ -inch minimum high-pressure water hose to the city water service.

Plug the 120-volt, 30-amp electrical cable into the city power service. The SmartPlug incorporates a reverse polarity feature which will include a series of light codes to let you know the condition of the power coming from the campsite power pedestal. Please refer to the provided SmartPlug owner's manual for more information on reverse polarity and the light codes.

To use the generator, you simply start it. All switching is done automatically. The generator can be started from any of the Multiplex System control panels. It is easier on your generator, and appliances, if you'll allow the generator to reach its normal operating speed (about a minute) prior to applying heavy current loads.

Your Touring Coach is equipped with an Automatic Generator Start System (AGS). The purpose of an AGS system is to automatically start (and run) the generator when the 12 volt electrical system (house batteries) drops to a pre-determined level. See Section 5 for more information on the AGS System.

Turn on the exterior LP remote power switch. Lighting a top range burner to bleed any air from the system will make it easier to start other appliances including the furnace.

When you stay for extended periods where electric or water hookups are not available, make sure to regularly check on the condition of your lithium batteries and the contents of your tanks. Both can be viewed from any of the Multiplex control panels. Carry drinking water in a clean bucket to refill your tank. When your waste tank nears capacity, move your touring coach to a dumping location.

Leveling

When you plan to stay in the same place for several days, weeks, or months, you will want your touring coach to be as level as possible. Check the attitude with a small spirit level set on the floor. If a correction is necessary, you must first level from side to side. This can be done most easily by driving up a small ramp consisting of 2 x 6 boards. Airstream does not recommend placing tires in a hole for leveling. Check the tire section of the chassis portion of this manual for information on tire support. Refer to Section 7 - Sprinter Van for more information on tires.

When leveling, select a spot that has a firm and as level as area possible. Most campgrounds provide this type of parking. Once leveled lower the stabilizer jacks for added support. Never use the stabilizing jacks to level the coach. Refer to Section 6 - Exterior for more information on the stabilizing jacks.

Effects of Prolonged Occupancy

Your touring coach was designed primarily for recreational use and short-term occupancy. If you expect to occupy the touring coach for an extended period, be prepared to deal with condensation and the humid conditions that may be encountered. The relatively small volume and tight compact construction of modern recreation vehicles mean that the normal living activities of even a few occupants will lead to rapid moisture saturation of the air contained in the touring coach and the appearance of visible moisture, especially in cold weather.

Just as moisture collects on the outside of a glass of cold water during humid weather, moisture can condense on the inside surfaces of the touring coach during cold weather when relative humidity of the interior air is high. This condition is increased because the insulated walls of a recreation vehicle are much thinner than house walls. Estimates indicate that two adults can vaporize up to one-and-a-half gallons of water daily through breathing, cooking, bathing, and washing. Unless the water vapor is carried outside by ventilation or condensed by a dehumidifier, it will condense on the inside of the windows and walls as moisture, or in cold weather as frost or ice. It may also condense out of sight within the walls or the ceiling where it will manifest itself as warped or stained panels. Appearance of these conditions may indicate a serious condensation problem. When you recognize the signs of excessive moisture and condensation in the touring coach, action should be taken to minimize their effects.

NOTE

Your touring coach is not designed, nor intended, for permanent housing. Use of this product for long term or permanent occupancy may lead to premature deterioration of structure, interior finishes, fabrics, carpeting, and drapes. Damage or deterioration due to long-term occupancy may not be considered normal, and may under the terms of the warranty constitute misuse, abuse, or neglect, and may therefore reduce the warranty protection.

To avoid condensation problems, try to follow these tips to help alleviate excess moisture:

- Allow excess moisture to escape to the outside when bathing, washing dishes, hair drying, laundering, and using appliances and non-vented gas burners. Always use an exhaust fan when cooking.
- Keep the bathroom door closed and the vent or window open when bathing and for a period of time after you have finished.
- If you are experiencing condensation, you may want to reconsider hanging wet clothes in the touring coach to dry.
- In hot weather, start the AC early as it removes excess humidity from the air while lowering the temperature.
- Keep the temperature as reasonably cool during cold weather as possible. The warmer the vehicle, the more cold exterior temperatures and warm interior temperatures will collide on wall surfaces, thus creating condensation.
- Use the ceiling vent to keep air circulating inside the vehicle so condensation and mildew cannot form in dead air spaces. Allow air to circulate inside closets and cabinets (leave doors partially open). Please keep in mind that a closed cabinet full of stored goods prevents circulation and allows the exterior temperature to cause condensation.
- The natural tendency would be to close the vehicle tightly during cold weather. This will actually compound the problem. Simply put, you need to remove some of the warm air and allow some cool outside air to get inside the vehicle so the furnace will not recycle the humid interior air.
- Minimize the use of incandescent lights, which produce heat and contribute to condensation.

General Information

About Molds

What are molds

Molds are microscopic organisms that naturally occur in virtually every environment, indoors and out. Outdoors, mold growth is important in the decomposition of plants. Indoors, mold growth is unfavorable. Left unchecked, molds break down natural materials, such as wood products and fabrics. Knowing the potential risks is important for any type of homeowner to protect their investment.

What factors contribute to mold growth

For mold growth to occur, temperatures, indoor or outdoors, must be between 40°F and 100°F and, there must be a source of moisture, such as humidity, standing water, damp materials, etc. Indoors, the most rapid growth occurs with warm and humid conditions.

How can mold growth be inhibited

By controlling relative humidity, the growth of mold and mildew can be inhibited. In warm climates, use of the air conditioner will reduce the relative humidity. Vents are located in the bathing and cooking areas and constant use is advised during food preparation and bathing, even during colder weather. Additionally, opening a window during these activities will assist in ventilation. In extremely humid conditions, the use of a dehumidifier can be helpful. If using a dehumidifier, please read and follow all manufacturer instructions and recommendations to the use and cleaning of the dehumidifier.

Frequent use of your touring coach or cleaning regularly is an important preventive measure. Further, any spills should be wiped up quickly and dried as soon as possible. Avoid leaving damp items lying about. On safe surfaces, use mold or mildew killing cleaning products. Check sealants regularly, and reseal when necessary to avoid water leaks. Proper preventive maintenance to the touring coach and its accessories, as described both in this manual and in accompanying literature, will provide the best protection to the touring coach.

Waste Water System

The main parts of the waste water system are the toilet, holding tanks, and tank dump valves (see Section 9 - Maintenance for dump valve information). The system is designed to provide complete self-contained toilet facilities, while on the road or parked, without being connected to a sewage line. It may also be used when parked while connected to a sewage hose.

Keep the dump valves closed with either method and empty the tanks when they are nearly full. The idea is to send a large volume of water through the tanks and hose at the same time to float solids away.

After the sewage tank has been emptied, close the dump valves and charge the tank by putting a few gallons of water in the sewage holding tank using the black tank flush inlet. This will spray the interior of the tank with water and help prevent solids from building up in the sewage holding tank. The addition of a deodorizing agent like Aqua-Kem will help prevent odors.

Should you ever have a buildup of solids, close the valves, fill the tanks about 3/4 full with fresh water, drive a distance to agitate the solids, and drain the tanks.

Things Not to Put into Toilet or Drains

- Facial tissues and feminine hygiene products (they do not dissolve like toilet paper).
- Automotive antifreeze, ammonia, alcohols, or acetone.
- Table scraps or other solids that may clog the drains.

Drain System

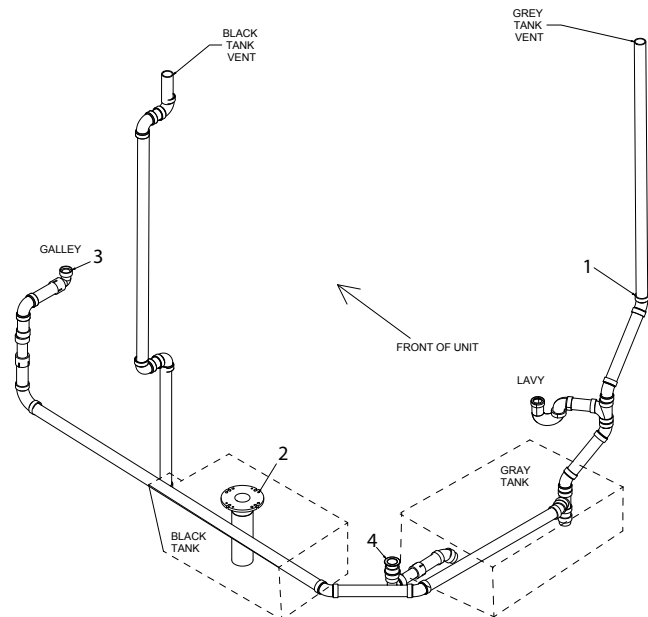

1. Lavatory Drain
2. Black Water Tank (Toilet)
3. Galley Drain
4. Shower Drain

Winter Traveling

Traveling in sub-freezing temperatures will require certain precautions to protect the plumbing system and your personal belongings from being damaged by freezing.

While traveling, simply use your common sense. How cold is it? How long will it be before you can turn the heat back on? Is the temperature dropping or rising? Remember, when driving at 50 MPH, the wind chill factor will cause the interior of the touring coach to cool much faster than a touring coach that is parked.

1. You must have a plentiful supply of fuel as the heat from the furnace warms the touring coach and keeps the fresh water lines from freezing.
2. If your stay is longer than overnight, you should endeavor to have 120-volt electricity available. Of course, you can run your generator to recharge the batteries, or even use the generator continually. Keep an eye on your generators fuel. Since the generator starts off the house batteries, it is recommended to start the generator prior to running the batteries down.
3. Minimize use of electricity if 120-volt power source is not available.
4. Leave cabinet doors, wet bath doors, and wardrobe doors slightly open at night to allow circulation of air in and around all components.
5. Save 12-volt power by using non-toxic RV-approved antifreeze in the water holding tanks instead of the heating pads to prevent freezing. Quantity of antifreeze needed will vary with ambient temperature and the amount of liquids in tanks.
6. For extended stays in cold weather, insulate all water lines outside the touring coach. You should remember that low temperatures in combination with high winds cause an equivalent chill temperature much below what your thermometer is reading. For instance, with an outside temperature of zero degrees, and the wind velocity of 10 miles per hour, the equivalent chill temperature is -20°F.
7. Remember to remove and drain the exterior shower faucet to prevent freeze damage.

Heated Tanks



The Atlas Touring Coach has 12-volt heat pads installed with the fresh water, grey water, and black water holding tanks to help prevent freezing. The tank pads are controlled by any of the Multiplex control panels throughout your touring coach. When the outside temperature is near freezing, simply switch "ON" the holding tank heaters. Built-in sensors will activate the heat pads when the contents of the tank drops to 44°F. Once the liquid is heated and rises to 64°F the heat pads will automatically deactivate. Switch the power "OFF" when the ambient outside temperature remains above freezing or the tanks are empty. The tank heaters will quickly deplete the house batteries unless the unit is plugged into an external AC power source or the generator is ran to operate the inverter/charger. To conserve battery power, RV antifreeze may be used to protect the gray and black tanks.

NOTE

Drain and winterize if the water systems are not being used during winter traveling. Refer to Section 9 - Maintenance in this manual for winterizing instructions.

AIRSTREAM®

Section 4 FLOOR PLANS AND SPECIFICATIONS

FLOOR PLANS	4-2
Atlas Murphy Suite	4-2
SPECIFICATIONS	4-3
Specification Tags	4-4

Floor Plans And Specifications

Floor Plans

Atlas Murphy Suite



Specifications

NOTE

The following specifications are as accurate as possible at the time of publication. Since we continually strive to improve our products, this information may change without notice. All capacities are approximate, and dimensions are nominal.

Atlas	
Chassis	Mercedes-Benz® Sprinter 3500 Chassis
Engine	Mercedes-Benz® 3.0L V6 Turbo Diesel
Emissions	BlueTEC SCR Technology, 50 State – EPA/CARB Standards
Horsepower/Torque	190 HP @ 3800RPM/325 lbs torque @1400-2400RPM
Transmission	7 Speed-Tronic
Axle Ratio	3.92
Wheelbase	170"
MPG	16-18 Estimated Highway*
Exterior Overall Length	24' 9"
Exterior Overall Height	10' 6" (with A/C)
Exterior Overall Width	7' 11"
Interior Height	6' 6"
Interior Width	7' 4.5"
GVWR	11,030 lbs
GCWR	15,250 lbs
UBW	10,090 lbs
NCC	940 lbs
Tow Capacity	Up To 5,000 lbs**
Fuel Tank	24.5 gallon
Fresh Water Capacity	20 gallon
Gray Water Tank	31 gallon
Black Water Tank	27 gallon
LPG	9.8 gallon
Water Heater (LPG)	60,000 BTU Continuous Flow
Air conditioner	15,000 BTU
Furnace	19,000 BTU
Refrigerator w/Freezer (12V - 120V)	9.1 cubic feet
Microwave	1.1 cubic feet
Cooktop	2 Burner with Integrated Cover
Generator w/Remote Start (Diesel)	Cummins Onan 3.2 kW
Batteries (House)	(2) 100AH Lithium with built-in heater
Converter/Inverter	50-Amp Multi-stage Charger, 1,000 Watt Inverter
Shore Power	30-Amp/120-Volt Service
Solar Power	400 Watt Solar System (300 Total Watts - House) (100 Total Watts - Chassis)
Bed Size	73" X 73"
Lug nut torque Max (ft lbs.)	140
Tire Size and Max Cold Inflation Pressure***	Front - LT215/85R16 - 61PSI Rear - LT215/85R16 - 58PSI
Airstream Warranty	3 Years/36,000 Miles
Mercedes-Benz® Warranty	3 Years/36,000 Miles
Mercedes-Benz® Engine Warranty	5 Years/100,000 Miles

*Actual Mileage may vary due to load, driving style, and overall conditions.

**Typical tow capacity will vary and is dependent upon build spec and intended vehicle loading with people, cargo, and fluids.

***In this context, the term *cold* refers to how long a tire has sat idle. *Max cold inflation pressure* should be checked in the morning (after sitting idle for at least three hours) before driving more than a one mile, or before rising ambient temperatures and the sun's radiant heat can affect tire pressure.

Floor Plans And Specifications

The Unit Base Weight (UBW) and Net Carrying Capacity (NCC) weights listed in the Specification Chart are for the base unit with LP and batteries included.

Gross Vehicular Weight Rating (GVWR) is the maximum permissible weight of this touring coach when fully loaded. It includes all weight at the touring coach axle(s).

UBW is the dry weight of the base unit without options.

Net Carrying Capacity (NCC) is equal to GVWR minus UBW. Gross Axle Weight Rating (GAWR) is the value specified as the load carrying capacity of a single axle system, as measured at the tire-ground interfaces.

Specification Tags

For precise cargo capacity, refer to the Cargo-Carrying Capacity tag on the inside of the door. The **WEIGHT OF CARGO SHOULD NEVER EXCEED** numbers shown on the tag, which is the maximum weight of cargo you can load and carry in your specific touring coach as built with its options.

Located on the driver's door jam of your touring coach are the Tire and Loading, and Vehicle Manufacturing tags.

The Tire and Loading information tag lists the Size and Cold Inflation Pressure of the tires on your vehicle, the weight of your touring coach as manufactured, and the GVWR.

The Vehicle Manufacturing tag lists the size of tires and wheel rims, maximum cold inflation pressures, the Vehicle Identification Number (VIN), and GAWR.

For a complete list of capacities, see the Specifications Chart on the previous page.

TIRE AND LOADING INFORMATION RENSEIGNEMENTS SUR LES PNEUS ET LE CHARGEMENT			
The weight of cargo should never exceed 744 kg or 1641 lbs. Le poids du chargement ne doit jamais dépasser 744 kg or 1641 lbs.			
TIRE PNEU	SIZE DIMENSIONS	COLD TIRE PRESSURE PRESSION DES PNEUS À FROID	SEE OWNER'S MANUAL FOR ADDITIONAL INFORMATION VOIR LE MANUEL DE L'USAGER POUR PLUS DE RENSEIGNEMENTS
FRONT AVANT	LT215/85R16LRE	420 kpa (61 Psi)	
REAR ARRIÈRE	LT215/85R16LRE	420 kpa (61 Psi)	
SPARE DE SECOURS	LT215/85R16LRE	420 kpa (61 Psi)	
The factory manufactured weight of this motor home is 4259 kgs 9389 (lbs). The GVWR of this motor home is 5,003.00 kgs 11030 (lbs).			

MOTOR HOME OCCUPANT CARGO CARRYING CAPACITY VIN:1B9HUWH29EJ303528	
THE COMBINED WEIGHT OF OCCUPANTS AND CARGO SHOULD NEVER EXCEED 744 kg OR 1641 LBS	
Safety belts equipped seating capacity : 9	
CAUTION: A full load of water equals 112 kg or 249 lbs of cargo @ 1kg/L (8.3lb/gal)	

NOTE

Specification tags shown are examples only.



WARNING

For safety reasons, the wheel tightening torque must be checked immediately after changing a tire and again after 30 miles to 140 ft-lbs. The wheels could otherwise come loose.

AIRSTREAM®

Section 5 INTERIOR

GENERAL INFORMATION AND CLEANING	5-3	Entertainment Cabinet	5-8
Ultra Leather	5-3	Storage Tips	5-8
PermaBlok3® by Spradling	5-3	Pedestal Tables.	5-8
Cabinets and Overhead Lockers	5-3	Driver and Passenger Seats.	5-8
Aluminum Interior Skin	5-3	Power Shades	5-8
Counter Area.	5-3	ELECTRICAL	5-9
Sinks	5-3	12-Volt System	5-9
Luxury Woven Vinyl Floor	5-4	12-Volt Operation	5-9
Protecting Your Floor From Physical Damage	5-4	Ceiling and Directional Lighting	5-9
Privacy Sun Shades	5-4	Multiplex System	5-10
Shower Stall	5-4	Systems Controlled By Firefly	5-10
Shower Head	5-4	Monitor Panel	5-11
Retractable Clothesline	5-4	Power Center	5-11
Toilet	5-5	Auxiliary Fuse Locations.	5-11
Deodorizers and Biological Chemicals	5-5	Energy Management System (EMS)	5-12
Faucets	5-5	Circuit Protection	5-12
Faucet Cleaning and Care	5-5	Operation	5-12
Lavatory Faucet	5-5	Display Panel	5-13
Galley Faucet	5-5	Service	5-13
Shower Head	5-5	Status	5-13
Shower Handle	5-5	Generator	5-13
Power Sofa	5-6	Automatic Generator Start (AGS).	5-13
Murphy Bed	5-6	120-Volt Power	5-14
Preparing the Sofa	5-6	120-Volt Automatic Switch Over Box	5-14
Lowering the Bed	5-6	Generator/City Power	5-14
Slide-Out Room	5-7	Battery Disconnect Switch	5-15
Before Operating the slide out Room	5-7	DC-DC Battery Converter	5-15
Extending and Retracting the Slide-out Room	5-7	Protecting the Charging System.	5-15

Section 5 Interior

Inverter/Charger5-15	APPLIANCES5-19
Converter5-16	Maintenance5-19
120-Volt System5-16	Air Conditioner5-20
City Power5-16	Heat Pump5-20
Ground Fault Circuit Interrupter5-17	Cooktop5-20
GFCI Breaker Test5-17	Ceiling Vent Fan5-20
ENTERTAINMENT SYSTEMS5-18	Operation5-21
Digital Media Player5-18	Thermostat and Rain Sensor5-21
Subwoofer5-18	Cleaning Instructions5-21
Video5-18	Furnace5-21
TV Operation5-18	Generator5-22
TV Antenna5-18	Microwave Ovens5-22
Cleaning Antenna Housing5-18	Refrigerator5-22
TV Wall Plate Power Supply5-18	Operation5-22
Operation5-18	Start up5-22
Antenna Pre-Wiring5-19	Defrost and Cleaning5-22
Roof Mounted Satellite5-19	Skylight5-22
Portable Satellite Antenna5-19	Solar System5-22
Connected RV Antenna Pre-Wire5-19	Water Heater5-23
		Control Center5-23

General Information and Cleaning

The interior of each Airstream Atlas has been designed for comfort, convenience, durability, and appearance. How you use it and how you take care of it, naturally, depends on you. However, if you learn to operate the interior components and take care of them and the touring coach properly, this knowledge will add to your pleasure, as well as the long life of your touring coach. All material should be professionally dry cleaned to remove any overall soiled condition.

Ultra Leather

Spot clean regularly with mild soap and water. For stubborn stains, wipe with isopropyl (rubbing alcohol) as soon as possible. Sanitize using a disinfectant such as a 5:1 water/bleach solution. Air dry or dry quickly with a hair dryer on warm setting.

NOTE

Never remove cushion covers for separate dry cleaning or washing. Any tumble cleaning method can destroy the backing, and/or shrink or otherwise damage upholstery fabric.

PermaBlok3® by Spradling

PermaBlok3® is a vinyl protective coating that's engineered to create a tough, effective barrier against the three biggest problems: germs, abrasion, and stains. You can not see it or feel it, yet the protection it offers results in extended performance and lasting beauty with minimum care. Most stains can be removed with a damp cloth and cleaned with a 1:1 mix of Ivory® soap and water. A 1:1 mix of ammonia and water, or a 1:4 mix of bleach and water can be used for more stubborn stains. Only if needed a 1:1 mix of isopropyl alcohol and water can be used. Use only a soft cotton cloth and rub the stain in a circular motion. Rinse thoroughly with clean water and pat dry.

Cabinets and Overhead Lockers

The furniture is manufactured from a high-pressure laminate and can be cleaned with soap and water, or you can use a common solvent on tough spots. Furniture polish can be used sparingly. Plexiglass doors must be cleaned with a antistatic cleaner and cloth. Windex or common ammonia products will damage the coating on the surface.

NOTE

Do not use any abrasive material, abrasive cleaners, cloths and pads as there is the possibility they could scratch the surface.

Aluminum Interior Skin

The metal interior skin on the ceiling is coated with a baked-on acrylic coating. Use soft rags or wash mitts always moving lengthwise with the grain of the aluminum. NEVER rub hard on the coating. Oil, grease, dust, and dirt may be removed by washing with a 5 percent solution of commonly used commercial and industrial multi-purpose detergent in water. Cleaning should be followed by a thorough clean water rinse. Drying the metal with a chamois or a soft cloth may prevent spots and streaks. When washing or waxing the metal, always wipe "with" the grain of the metal. A good grade of nonabrasive automotive paste or liquid wax once a year will increase the life of the finish.



CAUTION

Abrasive polishes or cleaning solvents such as automatic dishwasher or acid etch cleaners are too strong and should never be used. Rinse all grit from surface prior to washing. Use soft rags always moving lengthwise with the unit. NEVER rub with excessive pressure on the coating. Even the softest rag will damage the coating if excessive pressure is applied.

Counter Area

The solid surface counter tops only require everyday cleaning with a damp cloth or sponge. Dry with a soft cloth or paper towel to prevent spotting. Basic stains can be cleaned with an ammonia-based product such as household glass cleaner or non-abrasive spray-on cleaners for solid surface products. More stubborn stains can be removed by spraying a non-abrasive product such as Formula 409® over the stain and wait for a couple minutes. Scrub in small circular motions with a wet sponge followed by a rinse with clean water and drying with a soft cloth or paper towel. Avoid exposing the counter tops to strong chemicals such as paint removers, acetone, and oven cleaners. Promptly rinse, with water, spots that may have come in contact with these types of cleaners. A protective pad should always be used under hot utensils or pans.

Sinks

Cleaning can be accomplished using a mild liquid detergent on a soft cloth.

Luxury Woven Vinyl Floor

One of the best ways to keep the floor looking good is to wipe fabrics off on a weekly basis with clean water. This helps prevent dirt from becoming deeply embedded in the fabric and eliminates the need for more vigorous cleaning. For general or light cleaning, brush off loose dirt and wipe down the floor. Prepare a solution of water and mild soap such as dish washing liquid or household cleaner. Using a soft bristle brush to clean, apply a small amount of water and soap mixture to the stain. Rinse thoroughly until all soap residue is removed. Allow the floor to air dry. For more stubborn stains and mildew, prepare a solution of 1 cup bleach and 1/4 cup mild soap per gallon of water. Apply a small amount of bleach and soap mixture to the stain and blot with a sponge or clean towel. Rinse thoroughly to remove all soap residue. Allow to air dry. A citrus based cleaner like D-Limonene can be used for tough dirt and grease spots. Ammonium based products are NOT recommended. All cleaning products need to be rinsed off thoroughly and air dried after cleaning.



CAUTION

Remember to protect the area around your flooring if using a bleach solution. Other fabrics may have an adverse reaction to cleaners containing bleach.

NOTE

The use of certain cleaning agents, including but not limited to powdered abrasives, solvents, and industrial strength cleaners is not recommended. Always follow the manufacturer's instructions. Check that the cleaner/polish is suitable for use with cushioned vinyl floor coverings.

Protecting Your Floor From Physical Damage

Rubber backing on doormats may result in yellow discoloration of the floor immediately beneath. Choose a natural fiber mat. Mats provided by Airstream are intended for use outside of the touring coach. Rubber feet on furniture may cause staining. Remove them altogether or place coasters or felt pads between them and the floor.

For spirit-based products such as shoe polish, solvents, hair dye, and permanent marker pens, wipe up spots and marks as quickly as possible. This also applies to strongly colored foodstuffs.

Corrosive substances such as acid and alkaline solutions can damage the surface of the floor. Clean up any spills quickly and carefully avoiding direct contact with the substance. Wear protective clothing such as gloves when doing so. Tar from freshly resurfaced or melted roads and pathways, and some inexpensive rubber shoe soles can cause stains. The above materials are likely to cause damage but are not considered restrictive.

Privacy Sun Shades

Privacy shades are provided for the front windshield and driver/passenger cab windows. The shades have magnets sewn into them that attach to the van.

Light brushing with an upholstery brush or gentle use of a vacuum cleaner will suffice in most situations. For heavy soiled conditions dry clean only. Washing the shades may void the warranty.

Shower Stall

To clean your fiberglass shower stall unit, use warm water and a liquid detergent. Do not use abrasive cleaners as they may scratch and dull the surface. Stubborn stains can be removed with solvents such as turpentine, paint thinner, or acetone. Restore dulled areas by rubbing with an automotive-type liquid cleaner, and then put the soft glow back into the sides of your unit with a light application of liquid wax. The teak used in the shower is the highest grade available and has been oiled with Interlux™ Premium Teak Oil. To clean use Maritime™ Teak Cleaner, a non-acidic/non-caustic powder cleaner, and rinse with clean water. Use only a soft bristled brush or sponge, always across the grain, for scrubbing. A single coating of teak oil may be re-applied from time to time.

Shower Head

The shower head is designed to give maximum flexibility in usage, and provides for water-saving techniques when using your touring coach on self-containment. It can be held in the hand and moved about the body. Normally, the best water conservation procedure is to wet the entire body, turn the water off, apply soap, lather thoroughly, and then rinse the soap off.

Retractable Clothesline

A retractable clothesline is installed for your convenience in the shower stall. To use, pull the line from the base and attach it to the holder on the opposite wall. Turning the nut on the base will tighten the line.

Toilet

Please see the toilet owner's/user manual for warranty, user tips, and maintenance information.

Always add water before flushing solids and toilet paper, and leave at least an inch of water in the bowl so that holding tank odors do not enter the living space.

To add water to the toilet, depress the flush pedal part way.

To flush, depress the pedal until it contacts the floor. When flushing liquids, depress the pedal for approximately 1–2 seconds. When flushing solids, depress the pedal until the bowl rinses. Flushing longer than necessary will cause the holding tank to fill too quickly.

NOTE

Flush only water, bodily wastes, and rapid-dissolving toilet tissue down the toilet. Failure to follow these instructions could cause clogging or damage.

NOTE

When you dump the bowl of the toilet, make sure all paper and solids have cleared the slide mechanism before you allow it to close. Failure to do so can cause the groove for the slide to become jammed and the slide will no longer close completely.

Deodorizers and Biological Chemicals

There are many deodorizers and processing chemicals on the market in tablet, liquid, and powder form. These not only combat odor, but also stimulate the bacteria that works to dissolve the solids and tissues in your waste tank. These chemicals should be introduced through the toilet prior to use per the manufacturers directions. It's also important to always add a few gallons of water by filling the toilet bowl a few times and depressing the foot pedal.

Faucets

Faucet Cleaning and Care

All that is needed to clean your faucet is a soft, damp cloth. Airstream does not recommend the use of scour pads, cleansers, or chemicals. The abrasive nature of these substances could damage the faucet's finish. A non-abrasive car wax will help to protect the finish.

Lavatory Faucet



Airstream Part #602399

Kohler - Model: K45800-4-BN

Galley Faucet



Airstream Part #602395

Kohler - Model: K-597-VS

Shower Head



Airstream Part #602402

Kohler - Model: K-99248-BN

Shower Handle



Airstream Part #602640-01

Kohler - Model: K-TS-45110-4-BN

Power Sofa



The sofa has power adjustment controls, located on the outside of each armrest, used to recline each end of the sofa. Also located on each armrest is a set of USB ports for plugging in your electronic devices.

Murphy Bed

Preparing the Sofa



The power sofa is also used as the base support for the murphy bed. Clear the surrounding area of any obstructions before you begin. Remove the dinette table and store in the drawer at the base of the sofa. Make sure the sofa is in its normal upright position and not reclined. Press and hold the right arrow switch located on the side of the sofa. Lower the sofa fully until it stops and release the switch. To return the sofa to its upright position press and hold the left arrow switch.

NOTE

Make sure to read, understand, and follow all information, Notes, Cautions, and Warnings in the manual before operating the Murphy bed.

Lowering the Bed

1. It is recommended that if you are using the Murphy bed with the slide-out wall extended to lower the stabilizing jacks. However, the Murphy bed has been designed for use without the wall extended. In this case the stabilizing jacks will not need to be used.
2. Remove the sofa armrests. The armrests are held on by Velcro and can be stored in the sofa's drawer.
3. Disengage murphy bed lock.

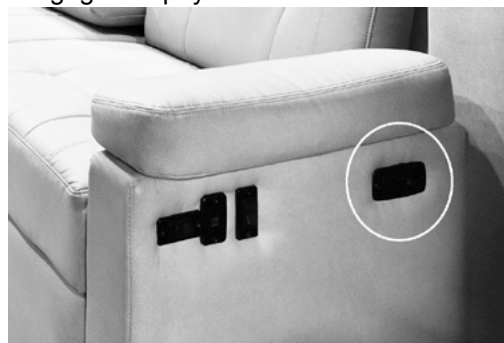

4. With Murphy Bed Lock Disengaged, rotate the pull handle in the upper corners of the wall and pull down to lower the bed. While lowering watch for any interference points. If there is any contact raise the bed and fix the interference before lowering again.
5. As the bed is lowered the headboard will flip down to fill the space between the bed and wall. If the headboard fails to lower simply flip it down by hand once the bed is lowered. In some cases, if the headboard wasn't flipped up before the bed was raised, the headboard may become lodged under the bed. If this should happen raise the foot of the bed slightly and flip the headboard up by hand.

To raise the bed follow the lowering steps in reverse order. Be sure to flip up the headboard before raising the bed. This will help prevent it from becoming lodged the next time the bed is lowered.

Slide-Out Room

The Airstream Atlas is equipped with an expandable slide-out room which provides extra living space. The slide-out rooms motor features a stop limit that will automatically stop the motor when the room is fully extended/retracted.

NOTE

Before operating, review all instructions in the Lippert InWall Slidout Owner's Manual provided in your owner's packet

Before Operating the slide out Room

1. Ensure the touring coach is properly leveled and supported using the stabilizing jacks.



CAUTION

If the touring coach is not properly leveled before extending the slide-out room, the slide-out mechanism may become damaged.

2. Make sure there is adequate space beside the touring coach for the slide-out room to be fully extended.
3. Check the interior of the touring coach to ensure there are no obstructions on the floor or leaning against the wall.
4. Check the exterior of the unit to ensure all exterior compartment doors are closed and all obstructions are removed.
5. Make sure all people stand clear before operation.



WARNING

Never drive the touring coach with the slide out room extended.

Extending and Retracting the Slide-out Room

The control switch is located inside the full height cabinet to the right of the entry door and is labeled for your convenience. The auxiliary section of the Multiplex control panels "Awning and Lifts" screen can also be used. Once pressed the screen will display "OPN" or "CLS" next to the Slide Out option.

1. Depress and hold the switch down (Extend) until the room is fully extended. Only when the room is fully extended is it completely weather tight. Leaving the room partially extended can allow moisture and dirt to enter the touring coach.
2. Depress and hold the switch up (Retract) to retract the room. Make sure the room has fully retracted ensuring a complete seal from the outside.

NOTE

Check for worn and cracked weather seals around the slide-out room. Extensive travel and use can cause the seals to deteriorate and may allow moisture and dirt to enter.

NOTE

Inspect Slideout for any visible signs of damage before and after movement of the room.

NOTE

When using the Multiplex panel Open/Close will replace Extend/Retract.

Entertainment Cabinet

The entertainment cabinet houses a hidden power lifted LED HDTV and sound bar. When the TV is not in use the cabinet can be used as additional counter space. When you want to watch TV press the TV lift switch located on the side of the entertainment cabinet at the entry door or on the Multiplex control panels. Pressing the TV lift UP button will activate the TV lift bringing the TV up through the cabinet top. When your ready to lower the TV press the DOWN switch and the TV lift will lower into the cabinet closing the counter top lid automatically.



CAUTION

Before activating the TV lift be sure the counter top is clear of any objects. The lift is designed to shut off automatically if the lid is obstructed and cannot open. However, the lid may open with lighter objects covering the lid which could cause damage to the lift mechanism or surrounding area.

Storage Tips

Cabinets should have the heaviest items stored on the bottom and lighter items overhead. Use unbreakable-type plates and saucers, and consider storing your dish towels around them.

Clothes hung in wardrobes should be kept on hangers that snap over the clothes rods to keep them from bouncing off on rough roads. Try to avoid large bulky coats. Layers of lighter clothing will usually keep you warmer, are more versatile, and are easier to store.

Pedestal Tables

The Atlas Touring Coach has two pedestal tables. One table can be installed in front of the sofa while the other is installed between the driver and passenger seats. The table tops and pedestal legs are designed to be stored in the middle drawer of the sofa base. The tables leg can be inserted into the floor mounted threaded socket and rotated to lock in place. The top is installed by inserting the pedestal leg into the socket installed on the underside of the table top. To remove, simply pull straight up on the table top. The leg is removed by depressing the black button on the floor socket and rotating the table leg.



WARNING

Return table tops and pedestals to their respective storage positions before moving the vehicle. In an emergency stop or accident the top and pedestal could cause personal injury and/or death.

Driver and Passenger Seats

The driver and passenger seats are provided by Sprinter, sent out to be recovered by Airstream to match the interior decor.

The seat adjustment mechanism provided by Sprinter allows the seat to be moved forward or backward and swivel left or right. Buttons near the door handle are used to move the seat forward and backward. Pressing down on the handle, centered under the front of the seats, allows the seat to swivel. Return the seat to the full upright position before using the swivel adjustment. The heated seats are activated by switches located on the door, next to the seat controls. For complete details on seat adjustments, please refer to the Sprinter manual.

Power Shades

All Atlas models come with power shades controlled by the Multiplex control panels. The shades feature a mechanical limit switch to prevent accidental loss or change of limits due to power surges or power outages. These presets are set at Airstream and shouldn't need adjusted.

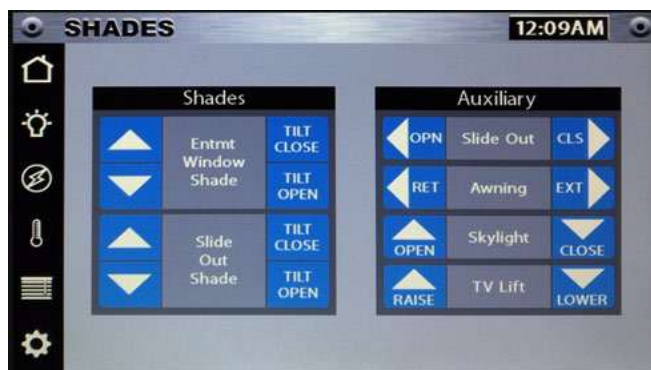

Screen images may vary slightly with continuous improvements/firmware updates

The multiplex main control panel allows for control over each shade. Pressing "shades" on the main control panel will display a screen for operating the entertainment window or slide out window shades. Pressing either the up or down arrow next to the shade you want to control will raise or lower the shade. If the same arrow is pressed before the shade reaches its pre-set limit stop the shade will stop at its current position. To tilt, press the tilt open or tilt close buttons. The shade will tilt a small amount with each tap of the button. The shade must be in its lowered position before tilting.

Refer to the Power Shades owner's manual for tips on cleaning.

Electrical

12-Volt System

The major portion of electrical power in your Airstream is 12 volt. The 12-volt current powers almost everything except the roof A/C, 120-volt receptacles, and microwave oven. However, some of these appliances have 12-volt electronic boards.

All 12-volt current is routed to a 12-volt fuse block. The fuse block is the hub of the 12-volt system tying together the inverter/charger and house batteries.

Power from the fuse block goes to a buss bar holding Type 2 thermal breakers. The thermal breakers then feed electrical components throughout the touring coach. One of the thermal breakers is fed by the house solar controller, providing some supplemental power, under ideal weather conditions.

Power is routed from the battery disconnect to the 12-volt distribution panel and through its branch circuits to the rest of the touring coach.



CAUTION

Thermal breakers break contact when overheated by a short or overload in the wiring. These breakers automatically reset when cooled down. A breaker continually overheating and breaking contact should be investigated by a qualified service technician.

12-Volt Operation

The only thing you have to do is make sure the house batteries do not run down. This should not be an issue if you are plugged into an external AC power source at night or when camping. When you're plugged into shoreline power, or running the generator, the converter charges the batteries and carries much of the load.

Some nights you may not find a place to plug into city power. This should not be a problem as well; you can continuously run your interior lights, water pump, and vents for about 8 hours on a full charge. However, you should monitor your battery voltage and start the generator, if needed. Fully charged house batteries will provide approximately 8 hours of moderate 12-volt usage. If the inverter is being used extensively the house batteries will be depleted much quicker.

If you are not plugged into city power, and you plan on staying longer than a day or two, you'll want to conserve your batteries by using as few lights and appliances as possible. Check the monitor system regularly. It's much easier on the batteries if you start the generator or run the chassis engine before the batteries run down. The generator starts from the house batteries so it must be started before they are depleted. If the house batteries become depleted, the chassis engine can be started to charge them. It could take a few minutes before the house batteries are charged enough to start the generator.

The engine battery and house batteries are isolated from each other by the DC-DC converter, preventing the two systems from drawing down simultaneously.



CAUTION

Airstream does not recommend the vehicle engine be run at idle speeds for more than one hour between 15 minute full temperature drive times.

Ceiling and Directional Lighting

All lighting in the Airstream Atlas is LED and most will require a replacement fixture should it go out or malfunction. Most lighting can be operated from control panels connected to the Multiplex System. The main touch screen control panel is located on the front overhead behind the passenger seat. The Circuit Control Board is located in the lower portion of the full height entry cabinet behind the passengers seat and is accessed by removing the false panel. Other control panels located throughout the touring coach include; on the wall next to the sofa, galley area, and bathroom.

The Multiplex System is self resetting should a circuit trip. The system should never need reset by the owner for any reason. If the main control panel or remote panels are not operating this could indicate a short in the wiring and should only be serviced by a certified technician.

NOTE

Several Multiplex control panels are installed throughout the touring coach. For best use of the Multiplex System Airstream recommends learning the functions of each individual panel. Refer to the owner's manual provided for tips and information on how to use the system.

Interior

Multiplex System

The Multiplex system provides advanced automation and mobile electrical solutions for your touring coach. Firefly is a multiplex network system designed to combine multiple signals across a media to reduce wires and simplify end user control. The system combines all desired functions and controls of the touring coach into a central location. Regional control panels are also installed to operate specific areas.

NOTE

Buttons that are controlling circuits such as Light Master and Panel Lights typically Do Not change from blue to white.

The Light Master button allows you to instantly turn ON or OFF all lighting in the interior of your touring coach. Pressing the Light Master ON button will turn on only the lights that were on when Light Master OFF was pressed. Holding the button ON for more than 1 second will turn on all the interior lighting.

NOTE

Pressing the Light Master ON after the Light Master OFF button has been pushed twice will result in no response. Hold ON to resolve.

Systems Controlled By Firefly

- Lighting (inside and outside)



- Power awning and awning lights
- Slide-out
- Skylight
- TV lift



- Shades

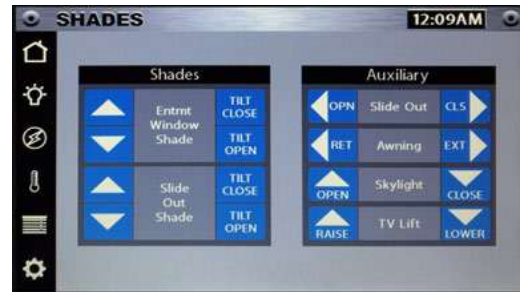

- Climate



- Tank monitoring (Fresh, Black, Grey and LPG)
- Battery voltage
- Tank heaters
- Water pump



Screen images may vary slightly with continuous improvements/firmware updates

NOTE

Warning alarms have been incorporated into the Multiplex System to warn of possible hazards. These warning alarms include; cabin door lock, slide-out extended, cabin door open, luggage door locks, chassis battery voltage, and folding step. If an alarm sounds check the main Multiplex control panel for a warning notification before proceeding.

Monitor Panel



Screen images may vary slightly with continuous improvements/firmware updates

The “Home” screen of the Multiplex Systems main control panel displays the fluid levels of the Black Water, Grey Water, Fresh Water tanks, and the LP gas tanks. The panel also shows the voltage status of the main (chassis) and the auxiliary (house) batteries.

The fluid monitoring system has been calibrated at the factory for the size tanks the Atlas uses and, therefore, should never need another calibration. The Seelevel monitor located in the entry cabinet can also be used to view fluid levels.

Power Center



The power center is installed in the lower right hand section of the entertainment cabinet. Open the decorative door for access to 12-volt fuses and 120-volt breakers.

The power center is a completely self-contained 120-volt power distribution and energy management system intended to be used in recreational vehicles. It is housed in a sheet metal enclosure with a removable front panel. It provides circuit protection for all the 120-VAC loads in the touring coach and works with the Energy Management System to minimize the over-loading and tripping of circuit breakers.

Refer to Section 9 - Maintenance for important battery maintenance information.



WARNING

The power center is a centralized power switching, fusing, and distribution center. The potential of lethal electrical shock is present in this box. Inadvertent shorts at this box could result in damage and/or injury. All servicing of this box should be done by a qualified Service Technician.

Auxiliary Fuse Locations

In addition to the 12-volt fuses and breakers described in this section, some components have additional fuse protection as supplied or required by their manufacturer. These locations are:

1. LP detector: 1-amp fuse, behind detector.
2. DC/DC Battery Separator power line to chassis battery: 150-amp in-line fuse, inside Sprinter battery compartment under the driver's floorboard.
3. DC-DC Battery Converter: 7.5 amp, under the passenger seat.
4. Rear view camera/monitor: 2 fuses (5 amp and 1 amp), located above the dome light. Remove light to access.
5. Sofa: 20 amp fuse for backrest and 15 amp fuses for each of the legs. Fuses are self-resetting and located behind the sofa. 7.5 amp USB ports
6. Water Heater: 5 amp fuse located in front of water heater.

NOTE

Most fuses will require a qualified technician to access and replace. Contact your dealer or Airstream Service Center.

Energy Management System (EMS)

The Energy Management System is located in the entry cabinet behind the passengers seat. A complete, EMS manual is included with your owner's packet.

The ENERGY MANAGEMENT SYSTEM controls 120-volt operated circuits to help keep the total 120-volt current draw to less than 30 amps. When operating on generator power the 120-volt draw will be less than 26.7 amps. These circuits may be any type load, but are typically heavier loads, those whose use can be "postponed" until a time when current is available for their use.

Circuit Protection

Circuit protection for ALL 120 VAC loads are standard residential resettable circuit breakers install in the Power Center (120 VAC section). Airstream has pre-installed the correct breakers per RVIA (NEC) listing requirements for the touring coach. The MAIN breaker for the touring coach is 30 amp and feeds the branch-breakers in the breaker box. Shutting off the MAIN breaker will remove power to all branch loads, except for receptacles on the Inverter circuit when the inverter mode is "ENABLED." The Inverter/converter contains a resettable 20 amp input breaker and a 15 amp output breaker. The remaining power center branch-breakers feed individual loads and are defined by the label affixed next to the breakers. The source for 120 VAC power to the power center can come from either the shoreline plug, when connected to a camp site, or the touring coach's generator, when running. If plugged into shoreline power, and the generator is started, the power feed to the power center will be coming from the generator.

The main and general load branch-breakers are operated similar to a light switch with up as "ON" and down as "OFF". If an overload condition or a short occurs the switch will snap to the "OFF" position. The load for this breaker will now be "OFF". Before resetting the breaker be aware of any device that may have been plugged in or turned "ON" which may have cause the breaker to overload. Unplug or turn "OFF" the possibly faulty device before resetting the breaker. To reset the breaker, you will need external AC power going to the breaker box (shoreline or generator), then firmly push the breaker switch to the "OFF" position then back to the "ON" position. If the breaker snaps back to the "OFF" position while resetting a fault condition still exists and should be serviced by a qualified Service Technician. If the breaker stays "ON" but snaps back to "OFF" after plugging in or turning ON the possibly faulted device a fault condition may exist in that device and should be service by a qualified Technician.

The power center Ground Fault Interrupt Circuit (GFIC) breaker is a special breaker that will provide additional safety to the occupants of the touring coach on the following receptacles; external, galley, lavatory, and entertainment. In addition to short circuit and overload protection the GFIC will shut off the breaker if any current feeding out of the breaker does not return to it. As in the case of a person contacting the electrical energized part of the GFIC circuit and an electrically conductive object not associated with the circuit.

Refer to to Ground Fault Circuit Interrupter and GFCI Breaker Test in this section for more information.

Operation

In operation, when 120 VAC and 12 VDC are initially applied, the system will energize the relays at one second intervals, closing the normally open contacts on each of the five relays while monitoring the total current. If the total should exceed the service limit, the system will turn off the last load that was turned on. As it does this, it calculates the amount of current that was removed, which is the value for that load. This value is placed in memory. The system has "learned" the amount of current that particular appliance draws. This feature compensates for the difference in current draw over a range of line voltage and ambient temperature, by relearning the load each time it is turned off.

The system now waits until the total current is lower than the service limit, by the amount in memory, before it will turn that load back on. This ensures that there is sufficient current to operate the load.

Display Panel



The display panel requires little user interaction and is provided to help the user understand power management. The display monitors the total AC current of the touring coach and prevents circuit breaker tripping by momentarily shedding loads. As additional appliances are turned on the system will begin to shed loads. As appliances are turned off, and a minimum of two minutes has expired, the system will automatically restore power to each of the shed loads.

Service

The “Select” button allows the service type to be set to either 15, 20, or 30 amps, to match the incoming service.

When power is first applied, the system will be in the 30-amp mode and the screen will display “Service 30A”. Momentarily pressing the “SELECT” button will switch the system to the 20-amp mode. Momentarily pressing the button again will switch the system to 15-amp mode.

Press the “SELECT” button to switch to either 15 or 20-amp service if it is necessary to use an adaptor or you know the shoreline power is 15 or 20 amps, The screen will display either “Service 15A” or “Service 20A”.

The generator supplies 26.7-amp service and is set to switch the system automatically to 26-amp mode whenever the generator is the power source. The screen will display “Generator 26A” when the generator is supplying power.

Status

The roof A/C and microwave are set at the factory to be the controlled circuits and are shed in this order.

This means if a power hungry electric grille is plugged into an outlet and the system begins to use more than 30-amps it will begin to shed loads and will shut off the air conditioner first.

Generator

The onboard generator makes your RV house electrical system fully self-contained. It allows you access to 120 volts when there is no shore power available. To use the generator you simply start it. All switching is done automatically. The generator can be started by pressing the start button on the switch in the overhead compartment behind the passenger’s seat or on the multiplex panel. It is easier on your generator and appliances if you’ll allow the generator to reach its normal operating speed (about a minute) prior to applying heavy current loads.

Do not operate the generator in an enclosed building or in a partly enclosed area such as a garage. Nor should the generator be operated while sleeping. Be sure to follow all instructions and warnings in this manual and the generator manufacturer’s manual.

Automatic Generator Start (AGS)

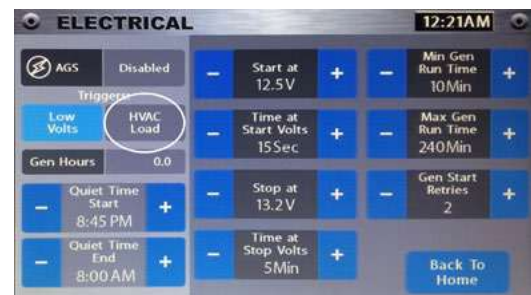

Your Touring Coach is equipped with an Automatic Generator Start System (AGS) which provides an optional automatic control of your onboard generator. The purpose of an AGS system is to automatically start (and run) the generator when the 12 volt electrical system (house batteries) drops to a pre-determined level. The AGS can be enabled to monitor the house battery bank and when it reaches a certain level, the generator will automatically start, sending a charge to your batteries. This protects the system so that your batteries will not go down farther. Once the batteries receive a sufficient amount of charge, the generator will automatically turn off. If you are in a location for an extended period of time, this can help protect the battery bank when shore power is not available.

The automatic start function of your generator requires you to manually enable it. This can be accomplished by selecting “Auto Gen Start Enable” on the Multiplex display and then pressing “on”. You will need to make sure that the “HVAC Load” button is activated.

Once enabled, AGS will remain enabled until the Sprinter Ignition is cycled or the generator is manually operated. After the vehicle is started, the AGS will be disabled. You can then return to the cabin to manually re-enable the system. It will then remain active until the vehicle is turned off. Any cycling, on or off, of the vehicle ignition will disable the AGS functionality.

If the generator is manually stopped while running and in an Auto Gen mode, it will disable future auto gen starts until re-enabled at the multiplex screen. If you manually start the generator when Auto Gen is enabled, it will disable the future auto gen starts until re-enabled at the multiplex screen.

Carbon Monoxide (CO) is a highly poisonous gas. Moving Parts and electricity can cause severe personal injury or death. To reduce exposure to these hazards, always disable AGS before

1. Sleeping in vehicle, unless equipped with a working Carbon Monoxide detector
2. Parking vehicle in a garage or confined space
3. Parking vehicle for storage
4. Servicing generator, batteries or other electrical appliances
5. Fueling vehicle



WARNING

Exposure to carbon monoxide, moving parts, and electricity hazards are possible due to unexpected starting of generator while in Auto Start mode.

120-Volt Power

When you're plugged into shoreline power or starting your generator, 120-volt current is fed to an Automatic Switch Over Box. Power from the box runs to the 120-volt circuit breakers through an Energy Management current sensor.

NOTE

Make sure to read, understand, and follow all electrical component owner's manuals provided in the owner's packet before operating the touring coach. Observe all operating instructions and Warnings as well as all recommended maintenance schedules and procedures.

120-Volt Automatic Switch Over Box

The switch over box automatically switches the 120-volt feed to the Energy Management System Module from shoreline to generator and back as you choose which way to power the touring coach. You simply decide whether to plug into a 120-volt shoreline or start the generator and the box will do the rest. If the generator is accidentally started while plugged into shoreline the box will sense the generator incoming power. Contact points inside the box will switch, cutting the shoreline connection and establishing the generator connection. This protects the system from a possible overload from dual power sources.

Generator/City Power

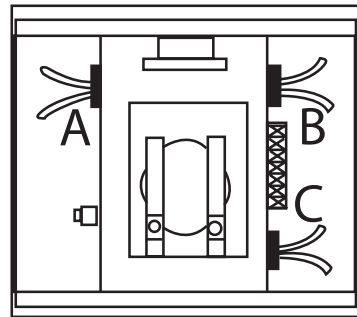

- a. To Energy Management System module main breaker
 - b. From generator
 - c. From shoreline
1. When plugged into shoreline power, the current path is from C to A.
 2. When you start your generator, the points switch and the power flow is from B to A. Stopping the generator releases the points back to shoreline feed.
 3. If you're plugged into shoreline and you start the generator, the points still switch since the generator has the priority, so the current flow is still B to A.

NOTE

Make sure to read and understand all electrical Component owner's manuals provided in the owner's Packet before operating the touring coach. Observe all operating instructions and Warnings as well as all recommended maintenance schedules and procedures.

Battery Disconnect Switch



The battery disconnect switch is used to separate the batteries from the 12-volt distribution panel and converter charging system. The Atlas battery disconnect switch is equipped with LED indicators. When the light is green the switch is ON and the batteries are charged. When the red LED begins to blink slowly it is an indicator the batteries should be charged. If the red LED begins blinking rapidly the batteries should be charged immediately before battery damage incurs.

NOTE

A rapidly blinking red LED indicates the battery charge is below 50 percent and future charging damage may incur. Airstream recommends charging the battery as soon as you notice the light blinking.

When the touring coach is plugged into an external AC power source the 12-volt distribution panel will receive power from the converter and the batteries will be charged through the converter charging system regardless of if the battery disconnect switch is in the ON/OFF position.

If the touring coach is NOT plugged into an external AC power source and the switch is turned to OFF the batteries are disconnected and the 12-volt distribution panel will not receive power from the converter. The converter will not charge the batteries with the switch in the OFF position with no shoreline power present. The OFF position is intended for storage of the touring coach or when power conservation is desired.

The solar panels will charge the batteries regardless of the battery disconnect switch position. Likewise, if ON or OFF, the generator will charge the batteries.

NOTE

As a safety precaution, the electric gas shut-off solenoid closes automatically when 12-volt power is disconnected, cutting gas to appliances. It will reopen when power is restored.

DC-DC Battery Converter

The DC-DC Battery Converter is located under the driver's seat. It is designed as a power gateway that only allows a maximum of 40 amps to pass between the vehicles alternator and the coaches converter.

Protecting the Charging System

The DC-DC Battery Converter monitors the house battery system to determine if the batteries are being charged. The charging can be accomplished through the inverter/converter or the vehicles alternator.

NOTE

In the event the engine battery is depleted, Sprinter recommends using a trickle charge only when charging the battery. When jumping the engine battery, do not use a power boost. Read and follow battery charging procedures in the Sprinter Owner's manual.

Inverter/Charger



The Inverter/Charger is a DC to AC inverter and a 50-amp multi-stage battery charger. The charger is derated to 80% (40A) for the Energy Management System. It has a remote control module mounted in the cabinet at the entry door behind the passengers seat.

The Inverter/Charger charges the batteries and converts 12-VDC to 120-VAC current for distribution to the entertainment devices. To operate your entertainment circuit the inverter must be ON, unless connected to generator or shoreline power.

If power is not needed to the entertainment circuit make sure the inverter is turned OFF to conserve battery power. The inverter will have a slight power draw even when turned off but the power consumption will be even greater if left on.



WARNING

An extensive owner's manual for the Inverter/Charger is provided in the Airstream Owner's Packet. Make sure to read, understand, and follow all information, notes, Cautions, and Warnings in the manual before operating the Inverter/Charger. All settings are calibrated at the factory and should not be adjusted.

Converter

The Airstream converter system enables you to use the 12-volt lights and equipment whether operating on self-contained battery power or hooked up to 120-volt city power. The 12-volt lights give off the same light as regular household bulbs, so that when operating on self-contained battery power, everything works normally except the 120-volt convenience outlets and 120-volt appliances.

NOTE

When operating with city power, make very certain that the service is 120 volt, not 240 volt.

The converter system is a transformer designed to maintain constant output voltages regardless of the variances that occur in city power systems. The design eliminates the need for complex electronic sensing systems to charge the batteries, minimizing the possibility of failures and greatly increasing its overall reliability.

In some older parks and other locations where three-pronged outlets are not available, certain precautions to ensure proper grounding and polarity must be taken. These precautions are listed below:

1. Attach the three-pronged plug to a two-pronged adapter. The third conductor line of this adapter has a short wire lead that must be grounded.
2. For proper grounding, connect the short ground lead to a grounded outlet box or to a cold water pipe. When no water pipe is available, drive a metal rod two feet into the ground and attach the ground lug to it, thus providing the unit with proper grounding.

NOTE

When the three-pronged plug can be used, there will be no problems with proper polarity or grounding with a properly-wired shoreline outlet.

120-Volt System

City Power

When your touring coach is hooked up to external AC power, the converter system automatically charges the touring coach batteries with the battery disconnect switch in either position. The speed and degree of charge depends on how much power is used for lights and appliances, as only the surplus goes to charging the battery. If you are making an extended stay, you should keep your touring coach hooked up to a 120-volt current if it is available.

While you are connected to external AC power, the wiring is protected by circuit breakers in the breaker panel. The circuit breaker panel for the 120-volt system is located in the converter. In the event of a failure of a 120-volt circuit, first check your touring coach circuit breakers and the breaker for the outlet into which your touring coach shoreline cord is plugged. If a breaker continues to trip after you have reset it several times, your circuit may be overloaded with appliances or there may be a short in the circuit. Try lessening the load on the circuit. Perhaps an electric griddle, hair dryer, or an electric heater can be turned off. If that does not solve the problem, consult an Airstream Service Center.

The 120-volt electrical system provides power to operate the A/C, converter, and 120-volt Receptacles for portable appliances. The power is carded through the 120-volt city power flexible cord to the 120-volt distribution panel, and then is distributed to each appliance or receptacle. Exterior 120 volt outlets are located in the curbside forward utility compartment.

All wire, components, and wiring methods conform to federal and state requirements.

Ground Fault Circuit Interrupter

Most states require touring coach's with exterior 120-volt receptacles and receptacles close to a water sources, such as a faucet to have a ground fault circuit interrupter (GFCI). When properly installed, the GFCI circuit breaker provides reliable overload and short circuit protection PLUS protection from Ground Faults that might result from contact with a "HOT" load wire and ground.

The system incorporates GFCI breakers that implement an auto self-test functionality. When turned off, these breakers require external AC or generator power to be present before they can be turned back on. If power is present from one of these sources, and the breaker refuses to stay on consult an electrician or certified RV technician.

Each GFCI circuit breaker is calibrated to trip with a ground current of 5 mA or more. Since most persons can feel as little as 2 mA, a distinct shock may be felt if the need for protection exists. However, the shock should be of such short duration that the effects would be reduced to less than the normally dangerous level. However, persons with acute heart problems or other conditions that can make a person particularly susceptible to electric shock may still be seriously injured.

While the GFCI circuit breaker affords a high degree of protection, there is no substitute for the knowledge that electricity can be dangerous when carelessly handled or used without reasonable caution.

GFCIs are proven lifesavers; however, consumers need to take a few minutes each month to do this simple test. By taking action, you can help protect your family from the risk of electric shock.



WARNING

The GFCI circuit breaker will **NOT** reduce shock hazard if contact is made between a "HOT" load wire and a neutral wire or 2 "HOT" load wires.



WARNING

The GFCI circuit breaker provides protection only to the circuit to which it is connected. It does **NOT** provide protection to any other circuit.

NOTE

All GFCI breakers implement an auto self-test function, however, Airstream recommends a manual test be conducted every month. If the test/reset buttons are not located on the GFCI receptacles they will be located inside the power center.

GFCI Breaker Test

Perform this test on the GFI circuit breaker each month and record the date.

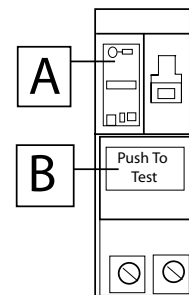

1. With handle A in "ON" position, press PUSH TO TEST button B.
2. Handle A should move to TRIP position, indicating that GFCI breaker has opened the circuit.
3. To restore power move handle A to "OFF" and then to "ON".

If the device remains on when the Test button is pushed, the GFCI is not working properly or has been incorrectly installed (wired improperly). If your GFCI is not working properly, call a qualified, certified electrician who can assess the situation, rewire the GFCI if necessary, or replace the unit.

Entertainment Systems

Digital Media Player

The touring coach comes equipped with a Fusion® Stereo which has an LCD color display. The stereo features several source options such as Bluetooth, FM radio, AUX and USB connections.

Download the Fusion-Link Remote Control App to adjust the volume, change the source, and control other functions of the stereo. See the Fusion Quick Start Manual for complete operating information.

NOTE

If the main “battery disconnect” switch does not power off the radio it will need to be turned off by pressing the power button on the radio.

Subwoofer

A dedicated volume control is installed under the passenger’s seat. Use the control to raise or lower the subwoofer to the desired volume.

Video

The Atlas Touring Coach is equipped with a LED HDTV and is pre-wired for a Blu-Ray player.

TV Operation

The TV is stored in the entertainment cabinets counter top and is raised or lowered by pressing the TV lift UP/DOWN buttons located on the side of the cabinet. A hinged lid will open to allow the TV to raise from the cabinet. Multiplex control panels can also control the TV’s movement through the “Auxiliary” screen. Press the “TV lift” button’s up or down arrows to raise or lower the TV.

NOTE

Before raising the TV make sure the counter top is clear to avoid damage.

TV Antenna



The installed omnidirectional antenna provides excellent reception of VHF/UHF TV channels. The TV antennas compact modern styling is unobtrusive and blends well with the designs of recreational vehicles.

The amplified signal maximizes signal strength to provide the best TV reception available in your area. The antenna receives free VHF, UHF and FM signals. Manufactured with durable automotive-grade plastic, the antenna is weatherproof, UV-protected and resistant to rust.

Cleaning Antenna Housing

The antenna is constructed with an automotive-grade plastic. Clean only with mild soap and water. Use no solvents, alcohol, or cleaning fluids. Do not power wash any part of the base mount of head of the antenna.

TV Wall Plate Power Supply



The wall plate/power supply provides 12 VDC to the antenna as well as antenna signals to the TV set. Cable input from the outdoor inlet connects to the wall plate and may be switched so either antenna or cable/satellite signals may be watched.

Operation

To receive cable signals from the outdoor inlet: Press switch to (OFF) position. The light on the wall plate will go OFF showing that power is no longer connected to the antenna and that the TV is receiving signals from the outdoor inlet. To receive signals from antenna: Press switch to (ON) position. The light on the wall plate will come ON showing that power is connected to the antenna and the TV is receiving signals from the antenna.

Antenna Pre-Wiring

Roof Mounted Satellite

The touring coach is pre-wired with a coax and power cable for a roof mounted satellite antenna. One end of the cable is coiled behind the Multiplex main control panel and is accessed by removing the screws from the side panel inside the front roof locker. The other end is coiled above the microwave. Remove the microwave to access the coax and power leads. A receiver can be placed inside the front roof locker.

Portable Satellite Antenna



The touring coach is also pre-wired for a portable satellite antenna. The exterior inlet is located in the roadside rear compartment of the touring coach and is labeled for your convenience. The interior pre-wire is located in the front overhead roof locker.

Connected RV Antenna Pre-Wire

The Airstream Atlas is pre-wired with a Connected RV high gain, multi-band antenna. This antenna, along with the Airstream router (sold separately), provides access to the internet by creating a local area network.

NOTE

When purchasing an Airstream router to activate the Connected RV features, a data plan will be required. Instructions on setup and data plans will be included with the router.

Appliances

All appliances are delivered to Airstream, Inc., with in-depth owner's manuals. Those manuals are included in the delivery case supplied by your dealer. The manuals may contain Warnings, Cautions, and operating instruction that should be read and followed before operating the appliances.

The information contained in the appliances manuals supersedes any information contained in the Airstream Atlas Owner's Manual on appliances. If you believe contradictory information on appliances is contained in this manual, or if any appliance manual(s) have not been provided with your vehicle, contact your dealer, the respective appliance manufacturer, or Airstream Customer Service at 937-596-6111 or write:

Airstream Factory Service Center

428 W. Pike Street

P.O. Box 629

Jackson Center, OH 45334-0629

(937) 596-6111

Maintenance

Follow the instructions and Warnings noted in the respective appliance and equipment owner's manuals, as well as those mentioned below.

Annual maintenance should be conducted on propane gas appliances and equipment by an authorized dealer or repair facility.

Insects can build nests in the burners of various appliances and equipment. The burner and burner orifice of the propane gas appliances and equipment should be cleaned by an authorized dealer or repair facility any time circumstances or conditions warrant, but no less than on an annual basis.



WARNING

Most LPG appliances used in recreational vehicles are vented to the outside of the vehicle. When parked close to a gasoline pump, it is possible that gasoline fumes could enter this type of appliance and ignite from the burner flame, CAUSING A FIRE OR AN EXPLOSION.

NOTE

Airstream recommends shutting off the LP gas supply before refueling the vehicle or entering a refueling station.

Air Conditioner

The roof A/C used on Airstream's Atlas has one of the lowest profiles of any A/C on the market today. Coupled with a fiberglass basepan this lower profile and lighter weight means less drag and improved fuel efficiency. In your owner's packet is a set of literature covering all operating and maintenance instructions. If the literature is misplaced, contact the A/C manufacturer or your Airstream dealer for replacement.

Proper voltage to the A/C is critical. A volt meter check may find voltage much lower at a campground shoreline outlet than the needed 110 to 120 volts. Low voltage is usually associated with older or poorly maintained motorhome parks. Parking your touring coach so the power cord can be plugged in to a receptacle close to the fuse or circuit breaker box can alleviate low voltage problems. Avoid extension cords and adapters whenever possible. If an extension cord must be used, it should be as short and heavy as possible to provide the most current.

If high temperatures are expected, make an effort to park in a shaded area. Starting the A/C early in the morning also helps. It is more efficient to hold a comfortable temperature than it is to lower the temperature after the interior of the touring coach is already hot.

NOTE

Clean filters Weekly when A/C is in full use.

Heat Pump

Your air conditioner has a built in heat pump designed to take the chill out of the air. To turn on, select "Climate" from one of the Multiplex control panels and set mode to "heat pump". Set the thermostat to your desired temperature.

NOTE

Review the air conditioning literature supplied in your owner's packet before proceeding.

Cooktop

There is little difference between the operation of home gas ranges and the touring coach's cooktop. If, however, you are used to an electric range, operating confidence can be quickly gained by reading the manufacturer's directions provided in the owner's packet. Manufacturer's service and parts manuals are also available.



WARNING

If the operation manual for the cooktop has not been provided with your touring coach, contact the listed manufacturer to obtain. Their manual contains specialized Warnings and Cautions that should be reviewed prior to operating the appliance.

Ceiling Vent Fan



The high-volume roof vent system is designed to quickly exhaust stale, hot air and draw in fresh air. It is great to use when the outside temperature does not call for air conditioning, but heat has built up in your touring coach.

The core of the system is a powerful rotary fan that works with a slightly open window to create a balanced airflow. It is designed for maximum air exchange, minimum sound levels and power consumption. Fresh, clean, natural air is pulled in. Hot, stale, stuffy air is pushed out. The vent can reduce the use of air conditioning allowing you to breath natural, fresh ambient outside air.

Operation

1. Open dome approximately 3 in. or more (ceiling fan has a built-in safety switch that will not allow motor to operate unless dome is partially open).
2. Turn 3-speed knob to desired performance level (3-Low, 2-Medium, 1-High, O-Off).
3. Open window(s) or door for airflow.

The source of airflow is determined by the number of window(s) or doors opened. For best results, close all roof vents and open one window that is the greatest distance from the ceiling fan.

NOTE

Never place Lindeen™ or a like cover over ceiling fan. Greatly restricted airflow and increased sound levels will occur.

Thermostat and Rain Sensor

The fan is equipped with a built-in thermostat. Select your comfort setting and the fan will automatically turn on and off as your touring coach heats up and cools down. When the rain sensor becomes wet the dome will close automatically and shut the fan off. Once the sensor has dried out the dome will reopen and the fan will restart.

1. Follow the previous operation steps one through three.
2. Select the desired temperature or comfort level using the thermostats knob. The fan motor will now start and stop automatically as the interior temperature of coach exceeds or drops below the selected level.

NOTE

Fan motor will not start if temperature selected is warmer than interior temperature of coach.

Cleaning Instructions

1. Turn fan motor off.
2. Remove the screws around perimeter of screen insert only.
3. Clean screen with soap and water solution, dab dry with a soft cloth, and reinstall.

**WARNING**

Do not use petroleum containing additives or solvent based products on any of the vent's components or its corrosion resistant hardware.

**CAUTION**

This product has been manufactured using prime UV stabilized Polymers for maximum toughness and durability. However, the use of non-compatible chemicals will cause cracking and product failure. Please refer to the user's manual provided in your owner's packet for more information.

Furnace

The manufacturer of the furnace in your touring coach has been well known in the motorhome industry for many years. The furnace burns LP gas, and is powered by 12-volt current from the batteries or power converter when plugged in to city power. Operating instructions are located in your owner's packet. If they should become misplaced, new literature can be ordered directly from the manufacturer or your Airstream dealer. The manufacturer also offers a detailed service guide for your furnace.

The furnace is located below the curbside wardrobe cabinet in the bath area and can be accessed by removing the false panel. The furnace is controlled by the Main Multiplex Control Panel located on the wall at the entry door.

**WARNING**

Carefully read all the manufacturer's instructions prior to operating. NEVER store flammable material next to the furnace or in close proximity to the furnace exhaust outlet on the side of the touring coach.

NOTE

If warranty service is required, use only a service location recommended by the furnace manufacturer or your Airstream dealer.

Generator

The diesel generator on the touring coach is mounted in the curbside rear compartment and is ideal for light and medium-duty applications with small size and weight constraints. It features an exceptionally quiet operation, single-side servicing, and an enclosed muffler. The generator can be started or stopped using the switch inside the entry cabinet behind the passenger's seat. Refer to Section 9 - Maintenance Schedule before operating for maintenance and oil changing tips.

NOTE

An owner's manual for the generator is provided in the Airstream Owner's Packet. Make sure to read, understand, and follow all information, Notes, Cautions, and Warnings before operating.

Microwave Ovens

Refer to the Certified Performance Checkout sheet, included in your owner's packet, for manufacturer, model, and serial number information.

Refrigerator

Review all refrigerator literature supplied in your owner's packet or stored in the refrigerator prior to operating it.

Operation

The refrigerator operates on 12-volt current from the batteries. All units are supplied with a wide range thermostat designed to sense the evaporator (cold plate) temperature. The coldest position on the thermostat is reached by turning the knob to the right (clockwise); conversely turning the thermostat knob to the left (counterclockwise) yields a warmer setting. The OFF position is reached by turning hard counterclockwise past the click. The reference point is shown with an indicator sticker beside the knob.

Start up

Turn the power on and set the thermostat between 3 and 4. You can make further adjustments to suit your personal requirements after the box has cooled down. Allow the refrigerator to come down to temperature before loading with product. Adding pre-cooled product will help keep the temperature stable when loading. Setting the thermostat to a higher setting e.g., 7, will not decrease the time required for the unit to cool down to its normal operating temperature.

NOTE

The refrigerator requires 12V power to operate. You must have the battery disconnect switch in the ON position, even if plugged into shore power.

Defrost and Cleaning

The frequency of defrost is dependant on the number of door openings, the ambient temperature and the humidity level. Typically, it is a good practice to defrost once there is ¼ inch of frost buildup on either side of the evaporator (cold plate). When defrosting, the unit is shut off by turning the thermostat counterclockwise to the OFF (0) position. Prop the door open. We suggest placing a towel in the bottom of the refrigerator to catch excess moisture.

Now that the unit has been defrosted, the interior can be cleaned with a non-abrasive cleaner. Do not use "Brillo" or "SOS" type abrasive pads, as they will score the surfaces. Baking soda is recommended.



CAUTION

Speeding up the defrost process with a knife or scraper is strongly discouraged due to the likelihood of rupturing the refrigerant circuit.

Skylight

The Atlas Touring Coach is equipped with a weather resistant, insulated skylight. The skylight can be conveniently controlled by the main Multiplex control panels "shades" screen.

Solar System



The rooftop solar panels installed on your Airstream help maintain battery health, reduce operating expenses, and extend the battery life of the batteries. The solar system's solar charge controller gathers energy from the individual solar panels and stores it in your batteries. The system features a display (shown above) that allows you to view live status information like solar watts and battery voltage.

To optimize solar charging, ensure the panels are clean and not shaded by trees or structures that might block the sun. Please refer to your owner's packet for reference material that discusses the solar system and its operation.

NOTE

The solar panel and charge controller are designed to maintain the chassis battery and help prevent it from dying; they are not designed to charge a dead battery. If the chassis battery is below 11.5 volts it will need to be charged by other means.

Refer to Section 9 for additional information about the solar system and the solar panel wiring diagram.

Water Heater

The Atlas Touring Coach is equipped with a continuous water heater featuring 60K BTU output, freeze protection, and direct spark ignition. The tankless water heater monitors inlet water temperature and flow, and output water temperature and flow.

Below is a representation of normal operating valve settings. When the valve is in the upright position the water valve is open. When winterizing or storing for long periods it is recommended to close the bypass valve by turning the valve a quarter turn. Refer to Section 9 - Maintenance for further winterization and storage instructions.



Control Center

The water heater is controlled by the Control Center located on the wall above the bathroom sink.



DISPLAY DESCRIPTION		
	BURNERS	3 BURNERS 5 BURNERS
	FLAME	This icon is displayed when FLAME is established.
	BLOWER	This icon is displayed when the BLOWER is running.
	TURN OFF WATER HEATER	This icon is displayed when the Water Heater is OFF.
	SETTING TEMP INDICATOR; OUTLET WATER TEMP INDICATOR	A. When setting the water temperature, the temperature display will flash. After SET Temperature is reached, the display stops flashing after a few seconds. B. When the demand for hot water has been terminated, the display will return to the SET Temperature.
BUTTON DESCRIPTION		
	ON/OFF	Power Button. Switches from turning unit ON or turning unit OFF.
	SWITCH	Hold for 5 seconds to switch between degrees (°) Celsius or degrees (°) Fahrenheit.
	UP	INCREASE SET Temperature by 1 degree increments. Setting range is 35°C/95°F to 55°C/130°F.
	DOWN	DECREASE SET Temperature by 1 degree increments. Setting range is 35°C/95°F to 55°C/130°F.

NOTE

Review the water heater literature supplied in your owner's packet before proceeding.



CAUTION

This appliance does not have a pilot. It is equipped with an ignition device which automatically lights the burner. Do not try to light the burner by hand.



WARNING

The water heater has built-in FREEZE PROTECTION and will intermittently cycle the burner when the water temperature is between 1°C/ 35°F to 4.5°C/40°F. To provide this freeze protection, the gas supply must be on, gas must be available and electrical power must be on.

AIRSTREAM®

Section 6 EXTERIOR

WAXES AND POLISHES	6-2	EXTERIOR DOORS	6-8
HOW TO CARE FOR YOUR TOURING COACH FINISH	6-2	Entry Door	6-8
Washing Your Touring Coach	6-3	Screen Door	6-8
Body Kit.	6-3	Utility Compartment Doors	6-9
Windows	6-3	Tail Lights	6-9
ROADSIDE EXTERIOR COMPONENTS	6-4	Opened	6-9
CURBSIDE EXTERIOR COMPONENTS	6-5	Closed	6-9
EXTERIOR FEATURES	6-6	AWNING	6-10
Alcoa Dura Bright Rims.	6-6	Awning Use In Wind and Rain	6-10
Cleaning Instructions	6-6	Awning Manual Override	6-10
Exterior Shower	6-6	Care and Maintenance	6-10
City Water Hookup	6-6	HITCH COVER	6-11
Exterior Folding Step	6-7	How To Remove The Hitch Cover.	6-11
Lock Extended Switch	6-7		
Power Stabilizing Jacks	6-7		
Receptacle, Cable, and USB Ports	6-7		
Shoreline Power Inlet and Cordset	6-8		
SmartPlug Inlet	6-8		
SmartPlug Cordset	6-8		

The Exterior cab and chassis portion of your Atlas Touring Coach has been painted by Sprinter. The Airstream up-fitted and body kit portions have been sent out by Airstream to be painted. Care of Sprinter's paint is detailed in their manual. The following additional information is provided by Airstream to help you understand the finish and its care. Following these instructions will provide a long lasting, high-gloss finish for your recreational vehicle. These same procedures can also be applied to your everyday automobile, producing the same long-lasting results.

NOTE

Information on finish care may provide additional information and tips on the use of the Sprinter Van as a touring coach, however, no information about the exterior finish of your touring coach in this manual should be interpreted as advice or directions to disregard or void the warnings, cautions, or other information contained in the Sprinter's manuals.

Waxes and Polishes

Over 90 percent of all automotive finishes are clear coat. The finish on your touring coach is a state-of-the-art Acrylic Urethane Basecoat/ClearCoat. This means you will wash and polish a clear urethane coating designed to protect the basecoat: the pigmented coating that provides color. As its main function is protecting the basecoat, the clearcoat needs to be maintained especially in harsh environments. Clearcoats do not fade themselves, but appear to fade or lose gloss as the surface becomes contaminated by the environment. If this contamination is not removed frequently, the result will be a dull or low-gloss finish. Occasional washing alone will not adequately remove some forms of contamination and polishing will be required.

Polishes and waxes primarily serve the following purposes:

1. To remove minor surface imperfections caused by water spots and acid rain
2. To remove minor scratches by filling them and leveling the surface
3. To beautify the paint finish appearances with more depth and high-gloss
4. To protect the paint finish from the elements

Do not use products that contain harsh abrasives such as rubbing or polishing compounds. These products should be used by experienced technicians with the proper training and equipment. Most polishes and waxes are designed to clean and polish in one application.

A hand-applied polish or wax will offer outstanding performance and protect the Atlas finish. When applying polish or wax, do so in a shaded area making sure the surface is at the specified temperature according to the polish manufacturer's recommendations. Due to the variations of polishes and waxes, incorporate the following suggestions into the polishing technique:

1. Condition the polishing pad by rubbing a slight amount of polish on it.
2. Use only the amount of polish specified in the label directions.
3. Work a small area at a time.
4. Rinse off and remove dried polish from crevices, trim, and moldings.
5. Follow the products manufacturer's directions.

How to Care for Your Touring Coach Finish

Keeping your touring coach looking its best at all times involves keeping the paint finish clean and in good condition. This means periodic washing and polishing, as well as getting the paint finish repaired as soon as possible when the paint is damaged or affected in any way. The purpose of the paint finish is twofold:

- Provide an aesthetically pleasing appearance.
- Protect the vehicle from the environment.

Your touring coach is exposed to many environmental conditions that have an adverse effect on the paint finish:

1. Road salts and sodium chloride
2. Road tar/bugs
3. Bird droppings/tree sap
4. Industrial fallout/acid rain/pollution
5. Ultraviolet exposure and moisture

The most common problems resulting from these conditions are corrosion, staining, and chemical spotting. These problems can be minimized through regularly-scheduled washing and polishing.

Washing Your Touring Coach

Make sure the touring coach's surface temperature is not too hot, under 90°F, and not in direct sunlight. A shady area is ideal for washing your vehicle, as direct sunlight causes water and soap to evaporate too fast, resulting in water spotting. Use a mild soap or detergent.

Most auto care stores carry a car wash shampoo. Try to avoid combination wash-n-wax products as these waxes cause buildup and are designed for smaller surfaces. Have two dedicated sponges or wax mitts: one for the paint finish and one for the wheels and under carriage. Brushes or wash mitts that have plastic bristles are acceptable for use on tires and wheel wells, but are not intended for use on the paint finish. Avoid using such items on painted surfaces, as they will damage the touring coach paint and finish.

Wash from the top and work your way down, frequently rinsing to minimize grit abrasion. Follow with a final rinse of water. This process will remove most contamination from the touring coach's surface. For stubborn stains such as road tar, use an ammonia-based glass cleaner or a small amount of rubbing alcohol on a damp cloth immediately followed by warm soapy water and rinse with clean water. This may not dissolve the road tar, but will loosen tar and bug stains and remove them from the surface. Do not use solvent-based cleaners on bird droppings or tree sap as these are water-based stains and will eventually dissolve using an ammonia-based glass cleaner, warm soapy water and a little "elbow grease." Once again, after removing stubborn stains immediately rinse with clean water.

Drying the touring coach is just as important as washing your vehicle as today's tap water and well water contain many chemicals that could water stain your touring coach's finish. We suggest using a damp natural or synthetic chamois, however, there are other drying products such as lint free micro-fiber towels that work just as well.

Follow these simple cautionary measures, and your new finish will give you maximum gloss and durability.

It is recommended that the caulking and sealant used in external seams and joints such as window frames, light bezels, beltline, and rub-rail molding, etc., be checked regularly. If this material has dried out and becomes cracked or checked, or if a portion has fallen out, it should be replaced with fresh material to prevent possible rain leaks. Caulking and sealing material is available from your touring coach dealer and most RV supply stores.

Body Kit



The body kit provided by Airstream is made from state-of-the-art high impact plastic. The same material is used in the automotive industry for moldings, bumper guards, and trim. The kit is made to color specifications and requires no paint or finish. The cleaning procedures are the same as the painted finish on the Sprinter body; however, there are several automotive plastic care products on the market for exterior parts that will provide added protection from UV ray damage, dirt, and stains. Find one you like and use it as often as needed to help prevent fading.

Windows

Clean your touring coach windows the same way you clean the windows in your home. Clean the seals with a damp cloth and mild detergent every 3 to 6 months. Do not use strong solvents, as they will damage the seals. A coat of natural silicone lubricant applied after the seal has dried will keep it flexible. Spread the lubricant evenly with a brush or finger, working it into the surface. This is a good practice for all rubber seals in your touring coach.



WARNING

Failure to properly clean and lubricate the window seals could result in the window sticking to the jamb and should only be released by a qualified technician trained in the procedure. Do not force, pry, or apply great pressure to open the window. Failure to heed this warning may cause the window to shatter and/or cause personal injury.

For replacement of a damaged window, contact an Airstream Service Center.

Roadside Exterior Components

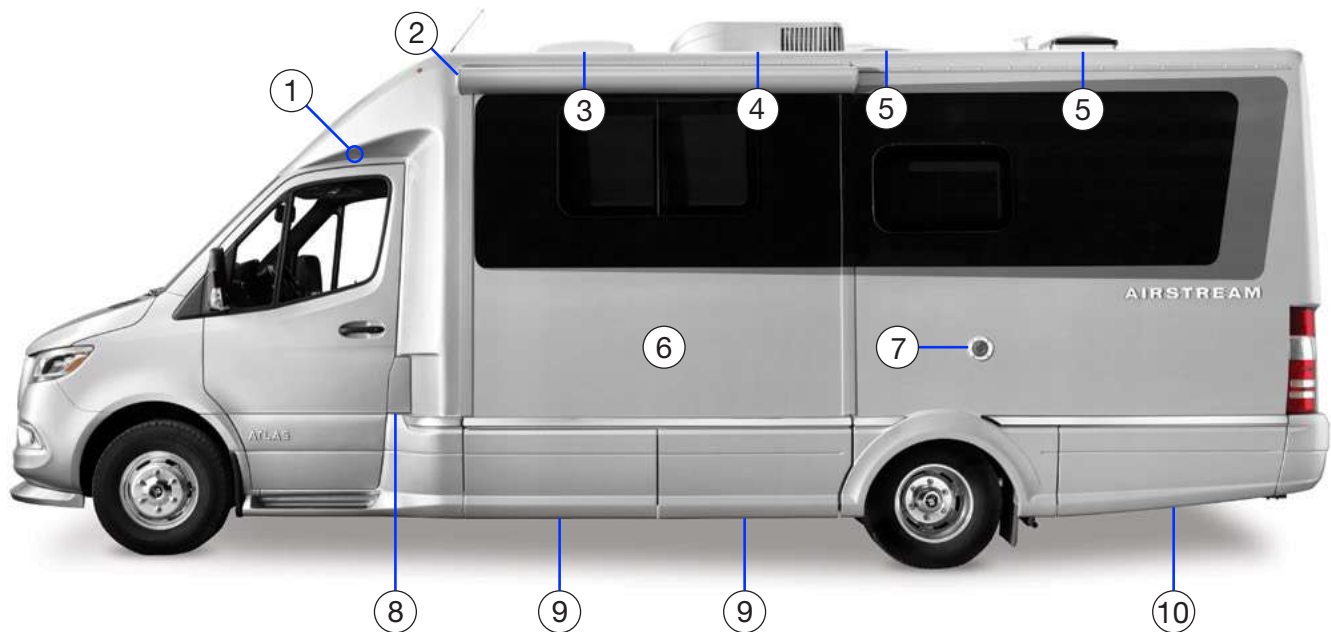

NOTE

Sections 6 and 9 contain additional information about these components. Mid-production changes may affect the exact location of the features shown above.

1. Exterior door light. Comes on when the door is opened and shuts off when the door is closed.
2. Slide-out awning.
3. Power skylight. Opens and closes via Multiplex System or the switch on the skylight.
4. Rooftop air conditioner
5. Ceiling vent fans.
6. Slide-out wall. Extended/retracted using the switch located in the cabinet at the entry door or by the main Multiplex control panel.
7. Hot water tank exhaust vent. When operating, be sure exhaust can escape into a well ventilated area as vent can be hot.
8. Diesel fuel door. Driver's door needs to be opened to access.
9. Weather sealed storage compartments.
10. Exterior rear compartment contains:
 - City water fill with regulator, provides access for city water to your fresh water system. Use ½ inch minimum hose for water supply. Water fill is also used to fill the fresh water tank. Turn on the fresh water valve switch to fill the tank. Use only clean fresh potable water.
 - Exterior shower, can be used on the water pump or with the city water hookup after hose assembly is inserted.
 - Macerator hose reel; contains the switches for the dump valves, macerator pump, and macerator pump high-pressure hose reel.
 - Black tank flush. Used for cleaning out the black tank.
 - LP tank remote fill and shutoff location.
 - Fresh water valve switch and Cable/Pre-wired Satellite TV inlet. The fresh water valve switch is used to open/close the valve for filling the fresh water tank.
 - 30-amp power cord inlet. Power cord can be stored inside.

Curbside Exterior Components

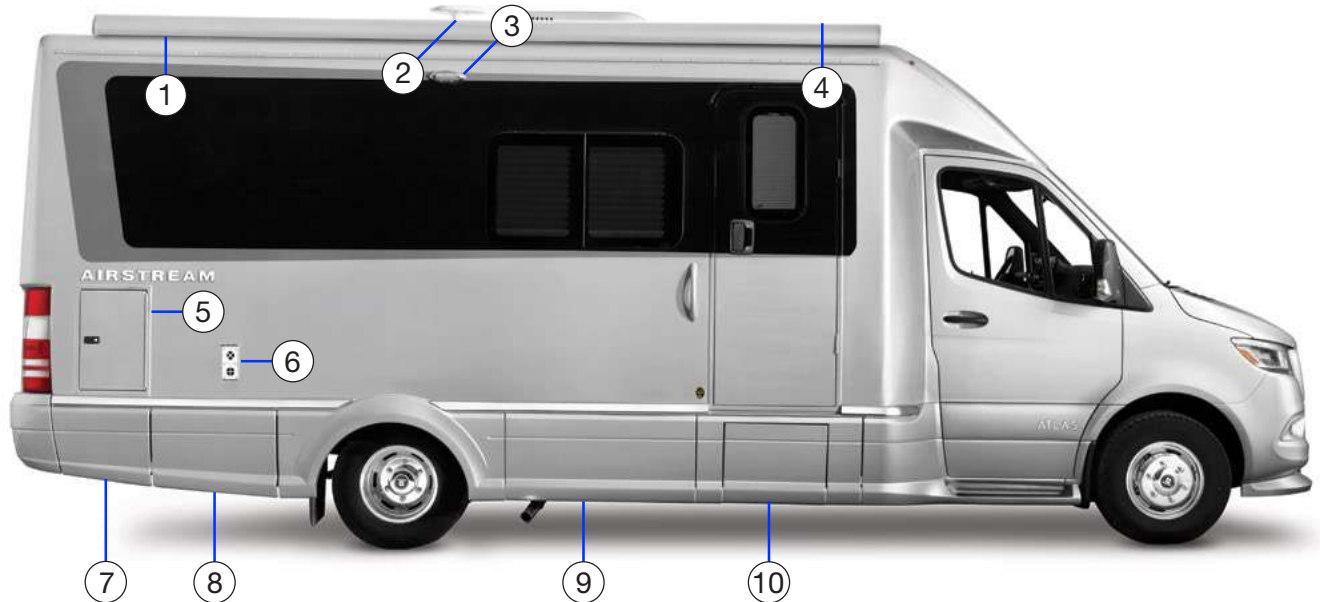

NOTE

Sections 6 and 9 contain additional information about these components. Mid-production changes may affect the exact location of the features shown above.

1. Patio Awning. Controlled by the multiplex system. See additional information at the end of this section.
2. Power boosted omni-directional TV antenna. Antenna is wired into TV outlets on exterior of coach and inside the front overhead roof locker.
3. Patio Light.
4. Connected RV pre-wired antenna (blocked from view by awning in photo above). Provides access to the internet by creating a local area network. Router required (sold separately).
5. Large weather sealed compartment with key lock.
6. Furnace exhaust vent. When operating, be sure exhaust can escape into a well ventilated area as vent can be hot.
7. Weather sealed rear compartment.
8. Generator compartment. All switching is done automatically once the generator is started from the multiplex panel.
9. Exterior compartment contains:
 - Exterior 120-volt outlet that provides an exterior GFCI protected electrical source.
 - TV outlet and HDMI port provides reception for an exterior television. It is pre-wired and integrated into the Cable/Satellite TV system.
10. Folding step with auto extend/retract, step out warning buzzer, and lock extended switch for easy entry into the touring coach.

Exterior Features

Alcoa Dura Bright Rims

Cleaning Instructions

These rims require no chemicals to clean them. Simply use a mild soap, water, clean towel, and rinse. Follow these steps for an easy clean and shine.

1. Rinse the wheel prior to washing with a brush. This will prevent scratching.
2. Mix a mild detergent and water. Any car wash or household detergent will work.
3. Using a soft clean brush and soap solution, clean the rims. (Do not use any abrasive-type brushes or pads.)
4. After cleaning the surface, rinse thoroughly to remove all soap so it will not spot. Towel drying will help this as well.



CAUTION

When using a power washer, maintain a proper distance from the touring coach. The proper distance is approximately 2.2 ft. when using a round jet nozzle, and 1 ft. when using a 25 degree flat spray jet nozzle. Never point the jet nozzle at moldings, hoses, electrical components, seals, plug connections, etc. Never use round jet nozzles on tires, the pulsating water can damage the sub-structure of tires.

Exterior Shower



All units are equipped with an exterior shower. This shower consists of a shower hose, shower head, and water valve inside the lockable roadside rear utility compartment. Water is supplied by the pump or city water hookup. To use: thread the hose onto the wall inlet, verify it is securely connected. Press the spout button and rotate the faucet handles to the desired temperature. To remove hose assembly, unscrew the hose from the water valve. Be sure to press the spout button to relieve any residual pressure before removing the hose.

City Water Hookup



The city water hookup is located in the roadside rear utility compartment of the touring coach. Your plumbing system has a built-in pressure regulator, limited to 50 psi, to protect your lines and faucets from extremely high pressures on some city water systems.

Use a tasteless, odorless, non-toxic, high-pressure hose of at least 1/2-in. diameter designed for motorhome use. The city water inlet is a standard garden hose thread. We suggest you carry two lengths of hose in order to reach hookups farther away than normal, as well as to have a spare.

After hooking up the hose, through the bottom access hatch inside the compartment, turn on the city water valve provided in the park and slowly open a faucet. There will be a lot of spurts and sputtering until all the air is expelled from the touring coach's system. It may take some time before all the air is expelled and a steady flow of water occurs. Once a steady flow is achieved at one faucet, the others should be opened long enough to expel the air in the lines going to them.

The water hookup is also used to fill the fresh water tank. To fill, turn ON the fresh water valve switch located below the shoreline power hookup. A red indicator light will turn on indicating the valve is open. When the switch is ON water is diverted to fill the fresh water tank. The valve will automatically close and the switch will turn OFF when the tank is full. If you wish to carry less than a full tank of water the fill percentage can be viewed on the main Multiplex control panels "Home" screen. Once the fill level reaches your desired percentage switch OFF the fresh water valve switch to close the valve.

Exterior Folding Step



The curbside door has a folding double step with auto retract, step out warning buzzer, and a lock extended switch located just inside the door. Please read, understand, and instruct passengers of the following operational and safety information pertaining to the step.

The steps extend and retract as the door is opened and closed with the engine off and step lock extend switch off. The steps retract automatically and will not extend when the engine is started to prevent damage while in transit.

If the steps do not retract fully, a warning buzzer will sound. The vehicle should not be driven if the steps fail to retract completely.

Lock Extended Switch

To use the lock extended switch, turn the engine off, open the door to extend the steps, and turn the switch on. The steps will now remain extended while opening and closing the door. Turn the switch off to return the steps to normal operating mode.

If you forget to turn the lock extended switch off before starting the engine, the steps will retract when the engine is started, however, they will not extend when the engine is turned off and the door is opened. To reset the steps, turn the engine off and the step lock extended switch off with the door closed.



WARNING

LOOK BEFORE YOU LEAP. The steps will not extend with the opening of the door when the engine is running. Check that the steps are extended before leaving and entering the vehicle. Failure to follow this warning could result in personal injury.

Power Stabilizing Jacks

The Atlas Touring Coach is equipped with a set of two power stabilizing jacks. The jacks are controlled by a switch located in the entry cabinet behind the passenger's seat. The stabilizing jacks should be lowered before the slide-out room is extended. Extending the slide-out room without first leveling and deploying the stabilizing jacks could cause the slide out mechanism to bind and become damaged.

Power stabilizing jacks automatically adjust to the terrain and should only be lowered until they make contact with the ground.



CAUTION

Stabilizing jacks are designed to stabilize the touring coach only. Misuse of the power jacks to level or lift the touring coach will result in damage to the jacks and potentially the coach.

Receptacle, Cable, and USB Ports

An exterior receptacle is located in the curbside utility compartment between the wheels and step. Also in this compartment is the exterior cable hook-up, HDMI inlet, and USB ports. A motion sensor light has been installed for your convenience. The light can be manually switched off if needed, however, if switched off the motion sensor will not function.

Shoreline Power Inlet and Cordset



SmartPlug Inlet

Your Airstream is equipped with a SmartPlug power inlet located on the road side of the touring coach. A few features of the SmartPlug include:

- Eliminates Overheating - Increased pin & clip surface area greatly improves electrical conductivity during high amperage demand.
- Ease of Use - No twist required, the unique plug body shape and push-in design means it only goes in the right way every time - even in the dark!
- Multi-Point Locking System - Side clips lock the plug securely into the inlet which eliminates any stress on the pins from movement of the power cord.
- Weatherproof Seals - Multi-fin silicone gaskets installed in the inlet cover and interior of the plug body eliminates moisture penetration.

Many campgrounds provide less than 30 amp service and your hookup may blow their fuse or circuit breaker. If this happens, reduce the load and replace the fuse or reset the breaker.

SmartPlug Cordset

The cordset (power cord) provided with your touring coach has a Reverse Polarity Indicator System. Reverse Polarity occurs when unknowingly connecting a cordset to a power pedestal that has the positive and negative leads reversed internally. Reverse Polarity is a safety concern and can damage electrical components on a coach or trailer.

On top of the SmartPlug power cord connector is two LED Indicator Lights, one blue and one red. When the SmartPlug is connected to a power source the lights will illuminate to indicate the status of a safe or unsafe condition:

- Blue ON, Red OFF - Normal Power
- Blue ON, Red ON - L1 and neutral are swapped in a reverse polarity condition
- Blue OFF, Red ON - L1 and ground are swapped in a dangerous reverse polarity condition
- Blue OFF, Red OFF - No Power

Exterior Doors

Entry Door

The side entry door is manufactured with a built-in, keyed dead bolt and door lock. The door lock, located below the door handle, is engaged from the inside by a red lever. The dead bolt, located above the door handle, is engaged by rotating the black knob. The door lock can be locked or unlocked using the key fob. The side door will only lock using the key fob if it is closed. To unlock using the key fob quickly double press the unlock button.

For lubrication and out-of-adjustment issues, refer to Section 9 - Maintenance.



CAUTION

When driving, the door lock and dead bolt must be secured. If it is not locked, the constant vibration of travel may cause the door to open resulting in possible damage.

Screen Door

The screen door is secured to the threshold of the main door and can be operated independently by sliding and latching it via a magnet catch. This innovated door takes a fresh approach to maximizing fresh air and your view while offering a smooth and steady screen operation.



CAUTION

Check that the screen door is retracted before closing the exterior door. Failure to follow this caution could result in damage to the screen door.

Utility Compartment Doors

The Atlas Touring Coach has several hidden utility hatches incorporated into the lower trim on each side of the coach. The compartment doors have no visible latches and are locked/unlocked using the key fob.

The utility compartment doors will lock when the lock button on the key fob is pressed or when the touring coach is in motion.

To unlock the utility doors quickly press the unlock button on the key fob twice. This will unlock the cab doors as well as the utility doors.

NOTE

To unlock the utility compartment doors at least one cab door must be closed. If both driver and passenger doors are opened the key fob will not unlock the utility doors.

NOTE

Alarms have been incorporated to warn of an open exterior compartment when ignition is started. If an alarm sounds check the main Multiplex control panel for a warning notification before proceeding.

Tail Lights

Atlas Touring Coach tail lights are hinged and can be opened to access for service. The tail light is held close by a magnet. To open, reach under the bottom edge of the tail light and pull.

Opened



Closed



Awning

The awning on Airstream's Atlas is a state of the art power awning. When retracted, the housing provides protection against the elements while blending in with the touring coach sidewall. The canopy can be partially or fully extended for the best shade coverage. The awning manufacturer provides a complete Owner's Operator Manual located in your owner's packet. The power awning is operated from the Multiplex control panels Auxiliary section on the "Shades" screen.



NOTE

If extended, the awning will automatically retract when the vehicle is taken out of "Park". When the vehicle is in motion the awning will lock, preventing it from being extended while traveling. The lockout will be reset and the awning can be extended again after the engine has been turned off.

Awning Use In Wind and Rain

The automatic extra strong awning comes with a Direct Response™ System wind sensor. The Direct Response™ System is an innovative wind sensor system that automatically activates the 12V motor and retracts the awning in strong winds, thus avoiding possible damage to the awning.

The awnings primary use is for sun protection, it is recommended the awning be retracted in case of rain, wind, or snow.

NOTE

If wind or extended periods of rain are expected, retract the awning and secure as for travel. The effects of wind and rain on any awning are unpredictable. Severe damage to the vehicle and or the awning may result and cannot be covered by warranty.

Awning Manual Override

If power to the vehicle is not available, the awning can be safely retracted using the manual override located on the idler (right) end of the case. A ratchet and socket extension has been included and is located under the passenger side compartment floor.

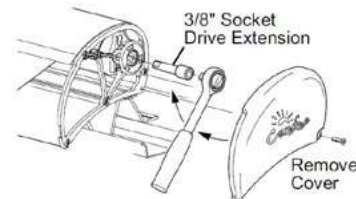

1. Remove the cover from the right end cap and save.
2. Insert the 3/8" socket drive extension and handle into the square drive hole inside the end cap.
3. Turn the handle clockwise until the awning is retracted.
4. Replace the end cap.

CAUTION

After closing the awning with the manual override, the lead rail may move out from the case 1/4"-1/2". This is normal and the awning is secure for travel until power is restored or repairs are completed. Do NOT attempt to force the lead rail in with the override, serious damage can occur to the awning.

NOTE

Manual override cannot be used to extend the awning.

Care and Maintenance

1. PERIODIC MAINTENANCE: Like any other part of the touring coach, an owner should periodically inspect the awning. The following items should be checked.
 - a. All mounting brackets are tight.
 - b. Check all pivot points for enlargements of holes or broken rivets.
 - c. Check end caps for cracking and splitting.
 - d. Check that awning rail is tight against coach and all screws are tight.
 - e. Check canopy for loose stitching and possible shrinkage or puckering.
 - f. Clean and lubricate all tension knobs and pivot points.

Fuse Location: Chassis fuse panel under driver's seat.

Hitch Cover

How To Remove The Hitch Cover

Before Removal



After Removal



1. Kneel down behind the rear bumper. There are two black wing nuts on each corner of the cover shown below.



2. Rotate each wing nut 1/4 turn, pull down and remove.

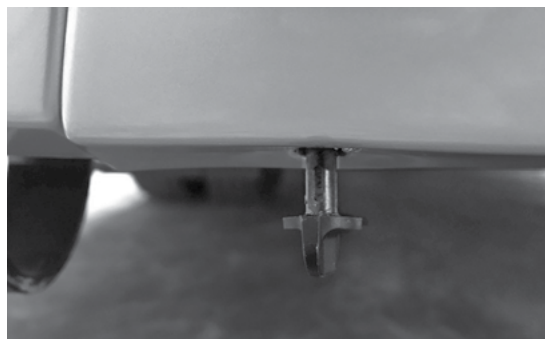

3. Pull straight down to remove the cover. Once removed you can store this in one of the utility compartments. Reverse these instructions to reinstall.



NOTES

AIRSTREAM®

Section 7 SPRINTER VAN

IMPORTANT SPRINTER INFORMATION	7-2	CHANGING A TIRE	7-5
Fuel	7-2	Flat Tire	7-6
COMPONENT IDENTIFICATION	7-2	Precautions When Changing a Wheel	7-6
Sprinter Van Serviced by Mercedes-Benz Sprinter or Its Suppliers	7-2	Procedure	7-6
Chassis	7-2	Jack	7-6
Driver's and Passenger's Seats and Restraint Systems	7-2	INSTALLING AND REMOVING A WHEEL	7-7
Airstream Components Serviced by Airstream Authorized Service Centers or Airstream suppliers.	7-2	Mounting a New Wheel.	7-7
Cab Area.	7-2	Centering Wheels With Wheel Nuts	7-7
Living Quarters	7-3	Lowering the Vehicle.	7-7
Electrical Components	7-3	Wheel Bolt Tightening	7-7
Exterior	7-3	TIRE ROTATION	7-8
Travel Warning Light.	7-3	Rotation Pattern for Dual Rear Wheels.	7-8
TIRES	7-3	Support	7-8
Vehicle Placard and Tire Inflation Pressure Label	7-3	Correct	7-8
Proper Tire Inflation	7-4	Incorrect	7-8
Under Inflation	7-4	AIR RIDE SUSPENSION	7-9
How Overloading Affects Your Tires	7-4	Manual Adjustments	7-9
Tires and Wheels	7-4		
Tire Grip	7-5		
Hydroplaning.	7-5		

Sprinter Van

The Airstream Atlas Touring Coach is integrated into a Sprinter Van designed and manufactured by Mercedes-Benz. Operation of the Sprinter, its engine, power train, and other related components are discussed in the Mercedes-Benz Sprinter Owner's Manual and other literature provided by Sprinter. As a point of reference, those systems discussed in this literature are warranted by Mercedes-Benz or their suppliers.

Important Sprinter Information

Your Mercedes-Benz Sprinter Van Operator's and Warranty Manuals contain important Cautions, Warnings, operational, and warranty information on the Sprinter and its components. All information in the Sprinter manual should be reviewed and followed for your safety. The Airstream Owner's Manual may provide additional information and tips on the use of the Sprinter Van as a touring coach; however, no information in the Airstream manual should be interpreted as advice or directions to disregard or void the warnings, cautions, or other information contained in the Sprinter manuals. If you believe there is a conflict in information, Warnings, Cautions, or safety-related information between the Sprinter and Airstream manuals, please contact the Airstream customer relations department immediately to resolve the conflict.

Fuel

The Mercedes-Benz Sprinter Owner's Manual contains important fuel requirement information on using Ultra-Low Sulfur Diesel, Bio fuels, and very low temperature operation. Please read, understand, and follow this information.

Component Identification

If repairs are needed, it may be difficult to determine which parts are Mercedes-Benz and which are Airstream's responsibility. The following partial lists show the major components of the van and the company responsible for their servicing.

For assistance in locating a service center in the United States:

Customer Assistance Center

Three Mercedes Drive

Montvale, New Jersey 07645-0350

1-877-762-8267

See Mercedes-Benz Sprinter Warranty Information Manual for complete instructions.

Sprinter Van Serviced by Mercedes-Benz Sprinter or Its Suppliers

Chassis

Engine	Speed control
Exterior automotive lights	Automotive electrical system
Engine battery	Instrument panel cluster
Power mirrors	Hitch receiver and tow plug
Engine cooling system	Cab doors
Fog lamps	Heated drivers/passenger seats
Transmission	Cab door windows and windshield
Chassis suspension	AM/FM radio antenna
Brakes	Dash Multimedia Center
Drive axle and hubs	Dash AC/heater/defroster
Steering assembly, Steering wheel	Cargo door assist handle
Heated windshield	Lane keeper assist
Automotive fuse panel	Blind spot assist
Wheels, Tires	High beam assist
Parking brake	Collision prevention assist
Alternator	Parktronics
Fuel pump	

Driver's and Passenger's Seats and Restraint Systems

Sprinter provides the swivel pedestals and Airstream provides the seat decorative skirting and recovers the front seats to match the surrounding decor.

Airstream Components Serviced by Airstream Authorized Service Centers or Airstream suppliers.

Cab Area

Driver's and passenger's seat skirting and covers.

Floor Mats

Dash Kit

Rear View Mirror/Monitor

Exterior door lights

Living Quarters

Fire extinguisher	Three piece sun and privacy shade
Interior furniture	Window Coverings
Appliances in the lounge/lavatory area.	Floor covering
Smoke/CO/LP detectors	All plumbing systems

Electrical Components

Monitor panel and its system	Multiplex System
Inverter/Charger	Living area entertainment center
House batteries	Roof AC
Battery disconnect	TV antenna
Power vents	GPS/Sirius antenna
120-volt system	TVs
12-volt living area system	

Exterior

Alcoa Dura Bright Rims	Air Ride System
Exterior body kit	Generator
Power step	Macerator pump
Exterior lights	Solar panels
Awning	

NOTE

Some Features listed may not be available on your Atlas.

NOTE

Please contact Airstream or Onan for a service location if repairs are need for the generator.

If you need further clarification or information, contact the Airstream Customer Relations Department at (937)596-6111 before contacting a service center for an appointment.

If you wish to write, the address is:

Airstream Inc.
 Attn: Customer Service
 428 W. Pike Street
 P.O. Box 629
 Jackson Center, Ohio 45334

Travel Warning Light

The travel warning light on the dash indicates that there is an open compartment or component which will make driving unsafe. Warnings include open Exterior Compartment, Awning, Skylight, extended Stabilizer Jacks or Step. See multiplex monitor panel if travel light is illuminated for displayed warning message.

Tires

Under inflation or over inflation of tires is dangerous. Under inflation can result in tire flexing, heat build-up, tire overloading, bad handling, bad fuel economy, and uneven wear. Over inflation can result in abnormal wear, bad handling, and harsh ride.

Tire inflation pressures should be checked as per the Mercedes-Benz Sprinter Owner's manual and when significantly changing the load you plan to carry in your touring coach. Set the correct tire pressure before loading the vehicle. Always check tire inflation pressures when the tires are "cold." See section 4 for tire specifications. Front and rear pressures and GVWR are shown for each model, and are based on the GVWR and front and rear axle ratings (GAWRs) printed on your vehicle VIN plate and certification label. Tires must be inflated to these pressures when the vehicle is fully loaded or an axle GAWR is reached.

Proper front end alignment improves tire tread mileage. Your front-end suspension parts should be inspected periodically and aligned when needed. Improper alignment may or may not cause the vehicle to vibrate. However, improper toe alignment will cause front tires to roll at an angle, which will result in faster tire wear. Incorrect caster or camber alignment will cause your front tires to wear unevenly and can cause the vehicle to "pull" to the left or right.

Vehicle Placard and Tire Inflation Pressure Label

The TIRE AND LOADING INFORMATION placard supplies information on the size and the cold tire inflation pressure for the original equipment tires supplied with your vehicle. Check the Sprinter manual for all weights and tire information placard location.

A MOTORHOME TIRE SAFETY ADDENDUM is included with your Airstream owner's packet. Please take the time to read, understand, and follow the information contained in the booklet.

Proper Tire Inflation

The level of air in your tires affects your vehicle's overall performance. Not even the highest quality tire will perform well if it's not inflated properly. The correct pressure varies from vehicle to vehicle and depends in part upon driver preference. Each vehicle has a recommended inflation pressure, usually found on a placard. Check the Sprinter manual for all weights and tire information and the placard location.

Correct tire inflation is a key component in tire care. The recommended inflation pressures for your tires are indicated on the certification label or in your owner's manual. Since touring coach's can be loaded with many different configurations, the load on each tire will vary. For this reason, air pressure should be checked based on the load on each individual tire. Cold Inflation Pressure should be adjusted to handle the maximum tire load, and all tires on the axle should carry the same inflation pressure. Cold tire inflation pressure is the tire pressure checked in the morning before you drive more than a few miles or before rising ambient temperatures or the sun's radiant heat affect it. Check your tire air pressure at least once a month, before each trip, and each morning you drive during a trip. Tire pressure should be checked cold, as tire pressure ratings have been designed with typical running heat/pressure build up in mind. Make sure the valves and caps are free of dirt and moisture.

Under Inflation

Under inflation brings a higher risk of susceptibility to damage due to road hazards, reduces tire casing durability, and causes a loss in fuel economy, plus uneven or irregular tire wear. Severe under inflation brings about an increased risk of tread separation, handling difficulties, and possibly tire failure, which is caused by overheating.

NOTE

It is a common practice for motorhome owners to lower tire pressure in their search for a smoother ride. This is not only dangerous, it is relatively ineffective, and the difference in ride quality is not significant. When minimum inflation pressure requirements are not met, tire durability and optimum operating conditions are compromised. Tire inflation pressure should always meet at least the minimum guidelines for vehicle weight.

- It may be necessary to inflate your tires at a truck stop or truck service center in order to achieve adequate air pressure for your coach's needs
- Only permanent air seal metal valve caps should be used.
- Be safe - if a tire has been run 20 percent under inflated, it must be dismantled and inspected by a trained professional. It should not be inflated without a full inspection or without using a safety cage. Use a calibrated gauge. If your tire is rated for higher inflation pressures, a special gauge designed for larger tires will be required.
- Don't bleed air from warm tires to reduce pressure buildup.
- Don't inflate tires to cold psi rating beyond rim specifications.

How Overloading Affects Your Tires

Tire pressure is what enables your touring coach tires to support loads. Overloading your tires can have serious consequences for passengers and your touring coach. Too much weight can cause stress on your touring coach's suspension system, brake failure, shock absorber damage, handling and steering problems, irregular tire wear and possible tire failure. Excessive loads or under inflation can lead to an excessive amount of heat and tire failure. If you discover that your tires cannot handle the load, lighten the weight of the load on your tires.

Tires and Wheels

(This section is partially excerpted from the Mercedes-Benz Sprinter Van Operator's Manual.)

Check tires regularly for even tread wear, tread depth (note legal requirements), and signs of external damage. Use only wheels and tires of the same size, make, and pattern.

Do not install tires that are not approved for the size and type of wheel installed on the vehicle itself. Only use those wheel sizes that were delivered to you by your authorized Mercedes-Benz Sprinter dealer.

Use only wheels and tires that have been tested and approved by the vehicle manufacturer.

Break in the tires at moderate speeds for distance of about 65 miles.

**WARNING**

Always replace wheel nuts that are damaged or rusted. Never apply oil or grease to wheel nuts. Damaged wheel hub threads should be repaired immediately. Incorrect mounting bolts or improperly tightened mounting bolts can cause the wheel to come off. This could cause an accident. Make sure to use the correct mounting bolts. Check tightness of wheel nuts regularly and retighten if necessary.

Tire Grip

Tire grip is greatly reduced on a wet or icy road. Speed and driving style must therefore be adapted to suit road conditions. Below a tread depth of 1/8 in., tire grip begins to decrease rapidly on wet roads.

Hydroplaning

Depending on the depth of the water layer on the road, hydroplaning may occur, even at low speeds and with new tires. Reduce vehicle speed, avoid grooves in the road, and apply brakes cautiously in the rain.

The majority of flood-related deaths are caused by people attempting to drive through moving water. Driving into flood waters may be the most dangerous thing one might ever try. Considering the following:

- Most cars will float (and be swept away) in 18-24 inches of moving water. Trucks and SUVs have only 6-12 more inches of clearance. Creeks and rivers can rise very rapidly and the road bottom can also wash away, making the water much deeper than it appears.
- Once cars are swept downstream, they will often roll to one side or perhaps flip over entirely. The driver has a few seconds to escape the vehicle. Many drivers panic as soon as the vehicle submerges and are found later with their seat belt intact.

Changing A Tire

(Partially excerpted from the Mercedes-Benz Sprinter Van Operator's Manual)

After changing a wheel, the wheel nuts must be tightened once the vehicle has been driven for about 30 miles.

If new or repainted wheels are fitted, the wheel nuts must be retighten again after about 600 to 3000 miles. Do not use remolded tires.

**WARNING**

Fitting wheel sizes other than those supplied by Sprinter to the vehicle will change the Sprinter's handling characteristics and may lead to an accident resulting in severe personal injuries, death and property damage.

NOTE

Read the Sprinter manual for wheel torque and wheel tightening procedures.

**WARNING**

The Mercedes-Benz Sprinter Operator's Manual contains important cautions, warnings, specifications, and operational information on changing, maintaining, and replacing of the tires and wheels. Read, understand, and follow the Sprinter manual sections for changing a tire.

**CAUTION**

Changing a tire on a touring coach chassis is a physically demanding procedure. It requires specialized tools and knowledge of safety procedures. Only you can determine your knowledge base and physical ability. Don't take any unnecessary risks. Find a safe area to park your unit, and call a tire service center and supply them with the information in the Sprinter Manual if you have any doubts about changing a tire.

Flat Tire

If you get a flat tire while driving, gradually decrease your speed. Hold the steering wheel firmly and slowly move to a safe place on the side of the road. The pressure of the spare wheel (sold separately) should be checked regularly (at least after every tenth time at the filling station).

The vehicle tool kit is located in a hatch under the front passenger foot well.



WARNING

Use a jack (sold separately) designed exclusively for jacking up the vehicle at the jack take-up brackets built into either side of the vehicle. To help avoid personal injury, use a jack only to lift the vehicle during a wheel change. Never get beneath the vehicle while it is supported by a jack.

Precautions When Changing a Wheel

- Keep hands and feet away from the area under the lifted vehicle.
- Always firmly set parking brake and block wheels before raising vehicle with jack.
- Do not disengage parking brake while vehicle is raised.
- Always use the jack on a level surface.
- Do not jack the vehicle up more than 1-2 in. between the tire and the surface. Otherwise, the vehicle may tip over and may cause serious injury or death to you or others.
- Be sure that the jack arm is fully seated in the jack take-up bracket.
- Always lower the vehicle onto sufficient capacity jack stands before working under the vehicle.
- Do not damage, grease, or oil wheel nuts or stud threads.

Procedure

- Park the vehicle on a firm, level, non-slippery surface.
- Switch on the hazard warning flasher switch, apply the parking brake, and place the transmission selector in "P".
- Everyone must leave the vehicle before you jack it up.

- Everyone must leave the danger zone before you jack up the vehicle. Danger zones vary with locations. Take a minute and look at what might happen if the vehicle falls off the jack and rolls. Set up your danger zone.
- The vehicle must be safeguarded in accordance with legal regulations (such as using a warning triangle).
- Prevent vehicle from rolling away by blocking wheels with wheel chocks (not supplied with vehicle) or sizable woodblocks or stone. On a level road place one chock in front of and one behind the wheel that is diagonally opposite to the wheel being changed. When changing a wheel on mild uphill or downhill grade, place chocks on the downhill side blocking both wheels of the other axle. Do not jack vehicle up on a steep grade.



WARNING

Do not change wheels on a steep uphill or downhill grade. The vehicle may begin to move and fall from the jack, which could cause property damage, personal injury, and/or death.

Jack

Read, understand, and follow the Mercedes-Benz Sprinter Operator's manual instructions, cautions, and warnings for changing a wheel and jack point locations.

- Loosen the wheel nuts before raising the vehicle.
- Close the release valve on the jack.
- Assemble the pump lever provided and insert it into the socket on the jack.
- Secure lever by turning it clockwise in the socket.
- Position the jack under the appropriate jack point and raise the vehicle by pumping the lever.



WARNING

A jack (sold separately) is intended only for raising the vehicle briefly, for instance when changing a wheel. The jack must be placed on a firm, flat surface only. Do not crawl under the vehicle while it is raised with a jack. Do not start the engine while the vehicle is jacked up. Do not jack the vehicle up more than 1-2 in. between the tire and the surface. The vehicle may tip over and cause serious injury or death to you or others. Jack stands must always be used while working beneath the vehicle. Failure to follow these precautions could result in property damage, personal injury, and/or death.

Installing and Removing A Wheel

- Loosen the wheel nuts.
- Jack up the vehicle until the wheel is clear of the ground.
- Unscrew the wheel nuts and remove the wheel (keep the wheel nuts clean).

NOTE

If the vehicle moves forward or backward while it is being jacked up, lower it, stabilize the vehicle, and repositioned the jack. When the vehicle is jacked up, the jack must stand vertically (plumb-line).

Mounting a New Wheel

- Before fitting a spare wheel, clean rust and dirt off the contact surfaces of the wheel and the wheel hub and from the wheel nuts.
- Note the specified wheel and tire size, tire load capacity, and speed code.
- Do not change the tire's direction of rotation.
- Do not damage, grease, or oil wheel nuts or their threads.

Centering Wheels With Wheel Nuts

- If dual assemblies are used, before placement, the inner wheel should be inspected to ensure all ball bearing rings are in the proper position.
- Install the wheel and snug the wheel nuts.
- Slightly tighten wheel nuts.

Lowering the Vehicle

- Slowly open the jack release valve to lower the vehicle until tire is resting on the ground.
- Tighten the wheel nuts in a crosswise pattern, as specified, with a torque wrench. For tire pressure and wheel bolt torque procedures, see the Mercedes-Benz Sprinter Van Operator's Manual.
- Remove the jack and stow.
- Check the tire pressure. For tire pressures see the Mercedes-Benz Sprinter Operator's Manual.
- Retighten the wheel nuts to the specified torque with a torque wrench after a distance of approximately 30 miles.



WARNING

Only certain tires meeting the tire size/load/speed index ratings contained in the Tire Pressure Tables, found in the Index Section of the Mercedes-Benz Sprinter's Operators or Owner's Manual, are certified to conform to FMVSS 120 for the Sprinter Vehicle. Please check the sidewalls of your originally-equipped tires for specific makes/sizes, and speed load ratings when you need to replace your tires. To prevent accident, injury, or possible death, use only the correct tires for your tire replacement.

Wheel Bolt Tightening

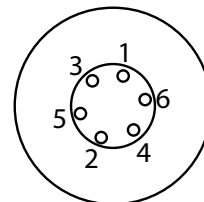

NOTE

Consult the Mercedes-Benz Sprinter Operators manual for extensive wheel tightening and wheel torque procedures, cautions, and warnings.

Tighten all wheel nuts evenly in the crosswise sequence indicated.



WARNING

For safety reasons, the wheel tightening torque must be checked immediately after changing a tire and again after 30 miles to 140 ft-lbs. The wheels could otherwise come loose.

Tire Rotation

Front and rear tires perform different jobs and can wear differently depending on the types of roads driven, driving habits, etc. To obtain the longest tire life, you should inspect and rotate your tires regularly.

Many automotive dealers and tire dealers will perform a free tire inspection to look for uneven or abnormal tire wear.

Tires should be rotated every 6,000 to 8,000 miles. For the longest tire life, any time irregular wear is seen have the tires checked, alignment checked, and tires rotated by your truck or tire dealer. Have the cause of uneven wear corrected.

Rotation Pattern for Dual Rear Wheels.

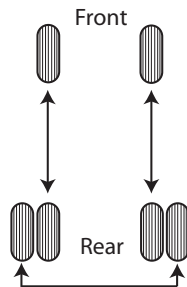

NOTE

Read the Mercedes-Benz Sprinter Operator's Manual for complete instruction on tire rotation, installation, and maintenance.

NOTE

Vehicles with aluminum alloy wheels will require tires to be dismounted and remounted so as to leave rims in original locations because the dura bright finish is only applied to one side.

Support

Since touring coach's may sit for long periods it is important to properly support the tires if blocks are used for leveling.

Extreme caution must be taken to ensure that the tires are fully supported when using blocks to level the touring coach. The load on the tire should be evenly distributed on the block and in the case of duals, evenly distributed on blocks for both tires. If not done, the steel cables in the sidewall of the tires may be damaged and could lead to premature fatigue of the sidewall.

Correct

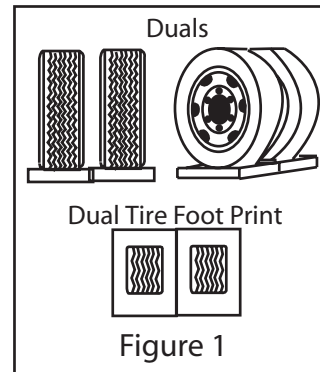

The CORRECT methods are shown in Figure 1. Dual tires are supporting the full load. Please note that the blocks are wider than the tread and longer than the tire's footprint. This provides maximum support to the tires and ensures that the load is evenly distributed throughout the tire's footprint area.

Incorrect

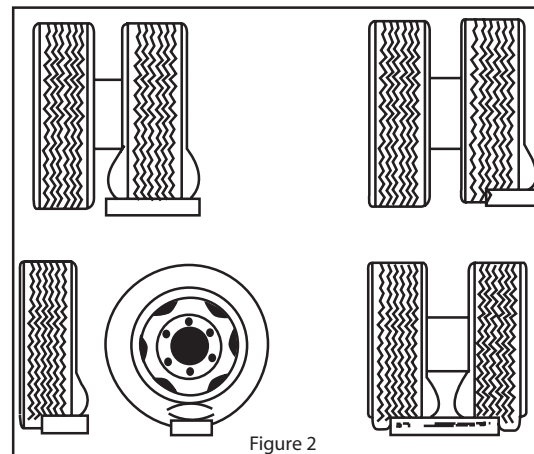

INCORRECT methods are shown in Figure 2: One tire, a portion of one tire, or portions of two tires are supporting the full load.



WARNING

Tires that are incorrectly supported may be damaged, which could lead to casing failure resulting in serious injury or property damage. If, on previous occasions, the tires have been incorrectly supported, hidden damage may be present. Please contact your local tire dealer and request an inspection and a determination of possible damage.

Air Ride Suspension

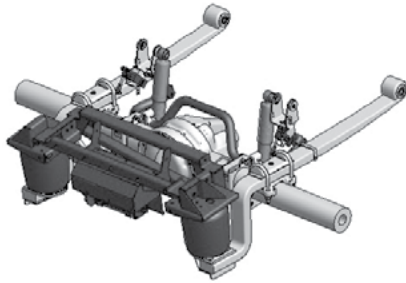

The touring coach is equipped with a rear axle air suspension. The Mercedes-Benz Sprinter Van is extremely suited for this air suspension system.

The full-air rear-axle air-suspension, has an electronic system which automatically monitors and adjusts the height level of the vehicle. This constant monitoring and adjusting will automatically contribute to safer vehicle behavior and better comfort.

The Atlas air ride system has a “ferry ramp” option allowing the touring coach to be driven at max height up to 7 mph, after which the coach will return to its normal ride height.

NOTE

Carefully read and understand all manufacturer’s instructions provided in your owner’s packet prior to operating.

Manual Adjustments



A remote, located on the B-pillar next to the drivers seat, can be used to manually adjust the air suspension. To manually adjust, while parked set the emergency brake. With the engine running, press the up or down arrows to raise or lower the rear of the van.

NOTE

Once the vehicle is in motion, the air ride system will automatically self-adjust to ride height. You can not manually adjust the height while the vehicle is in motion.

AIRSTREAM®

Section 8 DRIVING

LOADING	8-2	TOWING A TRAILER	8-6
Weighing	8-2	Towing a Boat	8-6
Vehicle and Trailer Weights and Ratings Definitions	8-2	Tracking	8-6
Procedure for Weighing a Touring Coach	8-3	Brake Controller	8-7
Weight Distribution	8-3	Backing Up	8-8
SAFETY	8-4	Rearview and Side Monitor System	8-8
Seat belts	8-4	Passing	8-8
TRAILER TOWING AND DRIVING TIPS	8-4	Parking Your Touring Coach	8-9
Hitch	8-4	TOWING YOUR TOURING COACH	8-9
Loading a Trailer	8-5	SAFETY CHECK LIST	8-9
Checking Weights of Vehicle and Trailer	8-5	Exterior Check List (Before Entering Vehicle)	8-9
Attaching a Trailer	8-5	Interior Check List (Before Driving)	8-10

Loading

One of the most critical aspects of safely operating a touring coach is knowing the weight involved and where it is placed. The first thing to determine is how much cargo is being loaded and confirming that it is within the capacity of the equipment being used. Determining WHERE that load is placed is critical to the way your rig will handle on the road.

Do not try to guess what your touring coach weighs loaded. Load your touring coach including water, propane, etc and take it to a public scale. Weigh each axle of your vehicle. Refer to your axle weight and tire limits to see if you are within a safe range. Total all axle weights and make sure you are below the GVWR. If you are not overloaded, make sure your load is balanced. Do not load too much on one side. A balanced load is much easier to tow or drive.

Front to back balance is also important. Step back and look at your touring coach. Make sure there is not too much weight in the front or on the rear of the touring coach. Be sure to secure all items. Loose items can cause damage and can be a safety issue.

The Cargo Carrying capacity tag shown below is installed on every touring coach and can be found on the inside of the door on your vehicle.

MOTOR HOME OCCUPANT AND CARGO CARRYING CAPACITY VIN # THE COMBINED WEIGHT OF OCCUPANTS AND CARGO SHOULD NEVER EXCEED XXX kg or XXX lbs Safety belt seating capacity:XXX CAUTION A full load of water equals XXX kg or XXX lbs of cargo @ 1 kg/L (8.3 lb/gal) and the tongue weight of a towed trailer counts as cargo
--

To arrive at “THE COMBINED WEIGHT OF OCCUPANTS AND CARGO SHOULD NEVER EXCEED” number, Airstream weighs the vehicle as finished and adds the weight of full tanks of LP and chassis fuel. That number is subtracted from the GVWR of the touring coach and listed on the tag, The total weight of any and all cargo, including but not limited to dealer or customer modifications or additions, fluids (fresh water and holding tanks), food, clothes, tools, tongue weight of a towed trailer or vehicle, and passengers should never exceed the number listed while the touring coach is in transit.

The “SAFETY BELT SEATING CAPACITY” is the number of passengers that seat belts are provided for.

The “A FULL LOAD OF WATER EQUALS” number is arrived at by multiplying the fresh water tank and water heater capacities by 1Kg/L or 8.34 lb/gal.

When loading the vehicle it is important to keep the GVWR, GAWR, Tire Weight Ratings (listed on the vehicle tire Information placard), and the cargo and occupant capacity in mind and not to exceed these specifications. Your safety depends on not overloading the touring coach, axles, and tires. See the specification section for the weight rating list of these items.

Weighing

To determine the actual weight of your vehicle with personal cargo and water, it must be weighed on scales as you plan to travel. The most common scales are those used by states to weigh trucks along the highway. In rural areas, grain elevators, gravel pits, and cement outlets are a good source.

NOTE

Weighing instructions for this touring coach are explained on the next page. If you have trouble locating scales, a call to your State Highway Patrol will usually find them cooperative in assisting you.

Vehicle and Trailer Weights and Ratings Definitions

Gross Vehicle Weight Rating (GVWR) is the maximum permissible weight of the touring coach.

Gross Vehicle Weight (GVW) comprises weight of vehicle including tools, installed accessories, passengers, cargo, and trailer tongue weight. It must never exceed the GVWR.

Gross Axle Weight Rating (GAWR) is the maximum permissible axle weight.

Gross Trailer Weight (GTW) is the maximum permissible trailer weight to be towed.

Trailer Tongue Weight Rating (TWR) is the maximum permissible weight of the trailer tongue. This counts as cargo when loading a touring coach.

NOTE

Check the Sprinter manual for all weights and the tire information placard location.

Front Axle GAWR	GVWR	Rear Axle GAWR	GCWR - GVW
SCALE WEIGHT		Optional Tow Weight	
STEP 1 Front Axle GAW	STEP 2 GVW	STEP 3 Rear Axle GAW	STEP 3a Tow Weight minus Weight of Trailer or Vehicle Towed
INDIVIDUAL WHEEL POSITION WEIGHT			
STEP 4 Left Front Wheel Position	STEP 5 Left Side (Total LF + LR)	STEP 6 Left Rear Wheel Position	
Calculated	Calculated	Calculated	
Right Front Wheel Position Step 1 minus Step 4	Right Front (Total RF + RR) Step 2 minus Step 5	Right Rear Wheel Position Step 3 minus Step 6	

GAWR = Gross Axle Weight Rating

GVWR = Gross Vehicle Weight Rating

GCWR = Gross Combination Weight Rating

Procedure for Weighing a Touring Coach

Vehicle should be weighed loaded, as you normally travel.

1. Fill in first row from Specification Section - 4 of this manual.
2. Weigh vehicle as shown in row 2 (Scale Weight) and fill in blanks.
3. Weigh one side of vehicle as shown in Individual Wheel Position Weight.
4. Calculate other side as shown in last row.

NOTE

Check the Sprinter manual for all weights and tire information placard location.

Weight Distribution

Touring coach's have fresh water, black and gray water tanks, and storage areas. It gives you great flexibility in loading. With flexibility comes responsibility. If you want to load down all the storage compartments, the amount of fluids may have to be reduced. It's a trade off so plan wisely. Distribute your additional cargo as evenly as possible with the heaviest objects located as low as possible.

Do you really want to carry a full fresh water tank to a RV park 1,000 miles away and then hook up to a city water supply? Even if you're going to a remote area, you can usually fill your water tank shortly before entering the area. Just reducing your load by 10 gal of water lets you carry an additional 83.4 lb of cargo.

Safety

Seat belts

Federally approved seat belts are provided for the use of the driver, passenger, and the lounge sofa. Most states require by law that all passengers in a motor vehicle use seat belts while in transit. It is strongly recommended that all occupants remain seated with their safety belts firmly attached while the touring coach is in transit. The driver should adjust his or her seat so that he or she is able to reach all controls easily with the belt on, and be able to use all the travel on the foot brake. Seat belts should be placed as low as possible around the hips to prevent sliding out from under them in case of an accident. This places the load of the body on the strong hipbone structure instead of around the soft abdominal area. Remember, there should only be one occupant per seat belt when traveling.

The driver and front passenger seat belt buckle operation is explained in the Sprinter manual.

The lounge sofa seat belt buckles are secured by inserting the male end into the female buckle until the buckles are secured. To release the buckle press the release button on the female end.

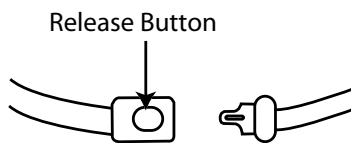

WARNING

Become familiar with and follow all directions, advice, and warnings pertaining to seats, seat belt operation, and restraint systems, provided in the Mercedes-Benz Sprinter Operator's Manual. Do not allow passengers to ride anywhere in the touring coach except in seats that are equipped with approved seat belts.



WARNING

Children must be secured in a federally-approved child restraint device. Failure to use proper restraints while in transit can result in severe or fatal injuries. Never place an infant seat that faces to the rear on the front passenger seat. Never place an unbelted infant seat on any seat while in transit.

Child restraint devices are designed to be secured with lap or lap/shoulder belts. All instructions supplied by the restraint manufacturer must be followed. Statistics have shown children are safer when properly restrained in a rear seating position than in a front seating position.

Don't hesitate when it comes to passenger safety. Make sure all passengers are properly restrained.

Trailer Towing and Driving Tips

(Some text is partially excerpted from Mercedes-Benz Sprinter Operators Manual.)



WARNING

Failure to use proper equipment and driving technique can result in a loss of vehicle control when towing a trailer. Improper towing or failure to follow the instructions contained in this section can result in serious injury. Follow the guidelines below carefully to assure safe trailer operation. Ask your authorized Mercedes-Benz Sprinter or Airstream dealer if you require an explanation of information contained in the manuals.

Hitch

Atlas units have hitches and wiring installed from the Mercedes-Benz manufacturer. The Sprinter 7- way connector is used for lights and charge line on a trailer. For further information, please see your authorized Mercedes-Benz Sprinter dealer.

To reduce the possibility of damage, remove the hitch ball adapter from the receiver when not in use.

Since this vehicle is designed and intended primarily as a load-carrying vehicle, towing a trailer will affect handling, durability and economy. Maximum safety and satisfaction depends upon proper use of correct equipment and avoiding overloads and other abusive operation.



WARNING

The total weight of the touring coach and trailer must not exceed the GCWR listed in the specification section of this manual. The maximum towing capacity varies according to the size of the touring coach and its GCWR. Vehicles should be properly equipped for towing trailers. Information on trailer hauling capabilities and special equipment required may be obtained from your Mercedes-Benz Sprinter and/or Airstream dealer.

Loading a Trailer

When loading a trailer, you should ensure neither the permissible GTW (Gross Tongue Weight), nor the trailer GVWR are exceeded.

Maximum permissible values are listed on the safety compliance certification labels for the vehicle and for the trailer to be towed. For their location, see the Mercedes-Benz Sprinter Operator's Manual. The lowest value listed must be selected when determining how the vehicle and trailer are loaded.

To assist in attaining good handling of the vehicle/trailer combination, it is important that the tongue weight be maintained at approximately 10-15 percent of the loaded trailer weight, but not to exceed the hitch rating. Tongue loads can be adjusted by proper distribution of the load in the trailer, and can be checked by weighing separately the loaded trailer and then the tongue.

The tongue weight at the hitch ball must be added to the GVW to prevent exceeding your Sprinter towed vehicle's rear GAWR.

When towing trailers, touring coach tires should be inflated to the highest pressures shown on the Sprinter Tire Information Placard. See Mercedes-Benz Sprinter Operator's Manual for its location. The Cargo Carrying Capacity (CCC) of this vehicle is reduced by the amount that equals the trailer tongue load on the trailer hitch.

Checking Weights of Vehicle and Trailer

To assure that the tow vehicle and trailer comply with the maximum permissible weight limits and to know the actual weights, have the loaded vehicle-trailer combination (tow vehicle including driver, passengers, cargo and trailer fully loaded) weighed on a commercial scale as explained earlier in this section.

Also, check the vehicles front and rear axle weights and tongue weight. The values as measured must not exceed the Sprinter weight ratings listed on vehicle information placards and in the Mercedes-Benz Sprinter manual. These ratings are also listed in the Specification section of this manual, Section 4 - Floor Plans And Specifications.

NOTE

Check the Mercedes-Benz Sprinter manual for all weights and tire information placard locations.

Attaching a Trailer

Please observe maximum permitted trailer dimensions (weight and length).

Most states and all Canadian provinces require safety chains between your tow vehicle and trailer. The chains should be crisscrossed under the trailer tongue. They must be attached to the hitch receiver and not to the vehicles bumper or axle. Be sure to leave enough slack in the chains to permit turning corners.

Most states and all Canadian provinces required a separate brake system for towing trailers.



WARNING

The towing vehicle's braking system is rated for operation at GVWR, NOT at the GCWR. A separate, functioning brake system is required for any towed vehicles or trailers weighing more than 1000 lb (450 kg) when fully loaded. NEVER exceed the GVWR, or the GAWR specified on a touring coach certification label. Also, NEVER exceed the weight ratings of a trailer hitch installed on a touring coach. Failure to heed any part of this warning could result in loss of control of the touring coach and towed vehicle or trailer which may cause an accident and serious injury. For specified towed vehicle braking requirements, consult the Mercedes-Benz Sprinter Operator's Manual that comes with the vehicle.



WARNING

Do not connect a trailer brake system (if trailer is so equipped) directly to the vehicle's hydraulic brake system if your vehicle is equipped with anti-lock brakes. If you do, neither the vehicle's brakes nor the trailer's brakes will function properly. Property damage, injury, or death to you or others may be the result.

The provided vehicle electrical wiring harness for trailer towing has a brake signal wire for hookup to a brake controller. Most states and all Canadian provinces require a breakaway switch on trailers with a separate brake system. The switch activates the trailer brakes in the possible event that the trailer might separate from the tow vehicle. Please consider using a trailer sway control system. For further information, see your authorized Mercedes-Benz Sprinter or Airstream dealer.

Towing a Trailer

There are many different laws, including speed limit restrictions, having to do with trailer towing. Make sure that your vehicle-trailer combination will be legal not only for where you reside, but also for where you'll be driving. A good source for this information can be the State Attorney General, State Police, or local authorities.

Before you start driving with a trailer, check the trailer's hitch, breakaway switch, safety chains, electrical connections, lighting, and tires. Also, adjust the mirrors to permit an unobstructed view beyond the rear of the trailer.

If the trailer has brakes using an electric brake controller, start your vehicle and trailer moving slowly, and then apply the brakes manually using the brake controller to be sure the brakes are working properly. Read and follow the controller manufacturer's recommendations.

When towing a trailer, check occasionally to be sure the load is secure, and lighting and trailer brakes (if so equipped) are functioning properly. Always secure items in the trailer to prevent load shifts while driving.

Take into consideration that when towing a trailer, the handling characteristics are different and less stable from those when operating the vehicle without a trailer. It is important to avoid sudden maneuvers.

The vehicle and trailer combination is heavier, and therefore is limited in acceleration ability and requires longer stopping distances. It is more prone to reacting to side wind gusts, and requires more sensitive steering input.

In order to gain skill and an understanding of the vehicle's behavior, you should practice turning, stopping and backing up in an area which is free from traffic.

If possible, do not brake abruptly, but rather engage the brake slightly at first to permit trailer to activate its brake. Then increase the braking force.

We want every owner to be a safe and courteous driver. A few hours of towing practice in a large empty parking lot will make pulling your trailer over the road much easier. Line out two corners for left and right turns. You may also use these corners to practice backing and parking.

Towing a Boat

While it is possible to tow a boat with your touring coach, Airstream does not recommend it. If you plan to pull and launch a boat, use caution when backing down boat ramps, and do not submerge any part of your touring coach in water. The slope of some boat ramps may be lower than others, requiring a portion of the tow vehicle to be submerged when launching. While this may be okay for some vehicles, your touring coach has sensitive electronics that water infiltration would irreparably damage.



WARNING

It is imperative that you do not allow any part of your touring coach to be submerged in water as it could cause damage to electronics that a warranty would not cover.

Tracking

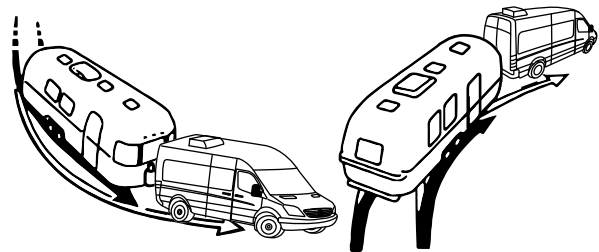

During practice, observe that the tracks made by the trailer wheels are distinctly different from those made by the tow vehicle. Studying this will make it easier for you to correct mistakes. Consider truck- or trailer-type fender or door grip rear view mirrors for maximum visibility. In most states, the law requires them.

After thoroughly inspecting your hitch, brakes, and tires, you should be ready to tow. Check traffic, signal that you are about to pull away, and start slowly. Look often in your mirrors, observe the action of the trailer, and then carefully move into the proper lane of traffic. Remember that the trailer wheels will not follow the path of the tow vehicle wheels; therefore, wider turns are necessary when turning to the left or right.

On freeways or expressways, try to pick the lane you want and stay in it. Always maintain plenty of space between you and the car ahead, at least the length of the tow vehicle plus trailer for every 10 mph. Remember that in order to pass another vehicle, you will need longer to accelerate. You must also allow for the length of the trailer when returning to the right hand lane. On a two-lane road cars may be lining up behind

you because you are traveling at a lower speed. It is both courteous and sensible to signal and pull over at the earliest safe opportunity and let them pass.



WARNING

Take into consideration that when towing a trailer, the handling characteristics are different and less stable from those with operating the vehicle without a trailer. It is important to avoid sudden maneuvers. Sudden maneuvers may lead to loss of control over the vehicle-trailer combination.

Brake Controller

The brake controller (if so equipped) is activated when you apply the brakes of the tow vehicle. Your tow vehicle brakes will automatically apply the trailer brakes first when properly adjusted. This will help keep your tow vehicle and trailer in a straight line and make you stop as if you were driving the tow vehicle alone. If swaying or swerving should occur, briefly operating the controller separate from the vehicle brakes may help correct the situation. Practice this maneuver on a clear highway. Do not wait for an emergency and then grope for the controller.

When towing a trailer, you might encounter a temporary cooling system overload during severe conditions such as hot days when pulling on a long uphill grade, when slowing down after higher speed driving, or driving long idle periods in traffic jams. If the hot indicator light comes on, or the temperature gauge indicates overheating and you have your AC turned on, turn it off. Pull over in a safe place and put on your emergency brake. Don't turn off the engine. Increase the engine idle speed. Lift the engine hood and check for fluid leaks at the radiator overflow outlet. Check to see that all drive belts are intact and the fan is turning. If you have a problem have it fixed at the next opportunity. If there is no problem the light should go off or temperature should come down within one minute. Proceed on the highway a little slower. Ten minutes later resume normal driving.

NOTE

If the transmission continually shifts between gears on inclines, manually shift to a lower gear. A lower gear and reduction of speed reduces the chances of engine overloading and/or overheating. When going down a long hill, shift into a lower gear and use the engine's braking effect. Avoid riding the brakes, thus overheating the vehicle and trailer brakes. If the engine coolant rises to an extremely

high temperature (e.g. coolant temperature needle approaching the red zone) when the AC is on, turn off the AC. Engine coolant heat can be additionally vented by opening the windows, switching the climate control fan speed to high and setting the temperature control to the maximum hot position.



WARNING

Never open a radiator cap when the tow vehicle is hot. Add coolant when the vehicle is cool.



WARNING

On slippery pavement, do not use engine drag to help slow down as this may cause the rear wheels of the tow vehicle to skid. On icy pavement, drive slowly and if you feel the tow vehicle skidding, gently apply the trailer brakes only. This will bring the tow vehicle and trailer back into a single line. Chains do not help trailer wheels.

When going downhill in dry weather, downshift so that engine compression will slow the whole rig down. Take dips and depressions in the road slowly and do not resume normal driving speeds until you are sure that the trailer wheels are clear of the dip.

When driving in mud and sand, let the momentum carry the rig through. Apply power gently and use as little as possible. Stay in the tracks of the vehicle ahead and keep the tow vehicle in the highest possible gear. If you are stuck, it is best to tow out the entire rig together without unhitching.

Despite even the best hitch, you will notice that whenever a large bus or truck overtakes your rig the displaced air first pushes the trailer rear slightly to the right and then affects the front. It may be necessary to steer very slightly, momentarily, toward the bus or truck to help compensate for the sway induced by the passing-vehicle. Do not apply the vehicle brakes, as this can tend to exaggerate the situation. You may find, however, that briefly applying the trailer brakes with your manual control will help eliminate sway.



WARNING

CHOCK THE TRAILER WHEELS when stopping on a hill or slope. Leaving your tow vehicle in gear is not enough for standstill safety. Do not use trailer brakes as parking brakes.

Backing Up

In BACKING UP the important thing to remember is to DO EVERYTHING SLOWLY and to correct immediately if you see the trailer turning the wrong way. Concentrate on the rear of the trailer. With your tow vehicle and trailer in a straight line, back up slowly and turn the bottom of the steering wheel in the direction you want the trailer to go. Watch from the window or in the mirror until the rear of the trailer is pointing in the desired direction. Your tow vehicle will be following the trailer in an arc. Straighten the tow vehicle and trailer by turning the steering wheel more sharply, and then when they are in line, straighten the steering wheel.

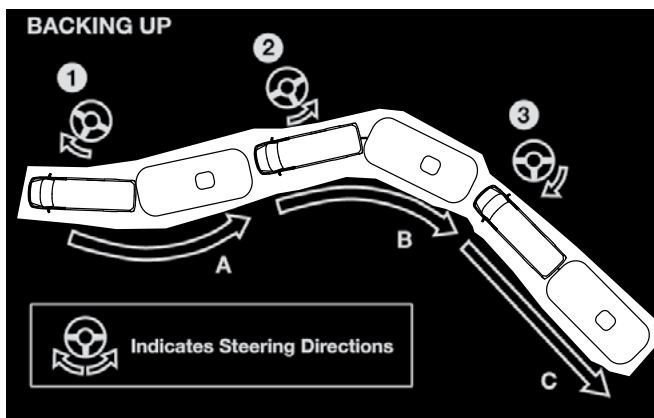

Start in position (A) start. Turning steering wheel as shown in (1). will put you in trailer position (B). Turning steering wheel show in position (2) puts you in trailer position (C). Steering position (3) returns front wheels to straight backing.

NOTE

Always try to back to your left because the visibility is much better.

When you do not make it on the first try it is usually much easier to pull forward to your original straight position and start over.

If your spouse or traveling companion normally directs you when backing they should position themselves forward of the tow vehicle so the driver can easily see them. Their directions should always indicate to the driver the direction the rear of the trailer should go. A little practice in a parking lot with the person giving directions can save a lot of frustration when backing into a campsite.

Rearview and Side Monitor System

An LCD digital monitor comes standard and replaces the existing rear view mirror. It comes with a built-in speaker and touch screen buttons to control all settings.

Included in the system are side cameras which are displayed on the digital monitor. Side cameras are activated with the turn signals. Putting on your right turn signal will display the passenger side camera and your left signal will display the drivers side camera. Putting the vehicle in reverse will activate the back-up camera. The rear camera is the primary, and will override the side cameras if the vehicle is placed in reverse. The rear camera can be turned on while driving for use as a rearview mirror by pressing the power button.

NOTE

Carefully read and understand all manufacturer's instructions provided in your owner's packet prior to operating.

Passing

Extreme care must be exercised when passing another vehicle. A vehicle with a trailer attached will require additional passing distance than when driving without a trailer. Because your vehicle and trailer is longer than your vehicle alone, you will also need to go much further ahead of the passed vehicle before you can return to your lane.

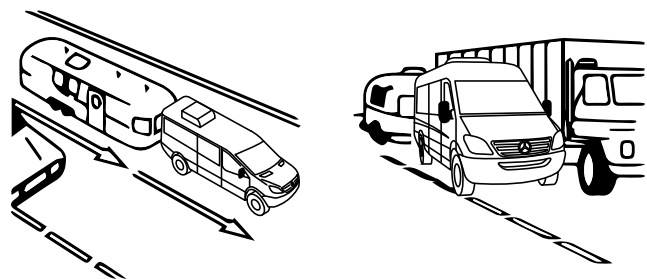

Parking Your Touring Coach

To reduce the risk of personal injury or damage to the vehicle power train as a result of vehicle/trailer movement, always:

- Keep right foot on the brake pedal.
- Shift gear selector lever to position “N”.
- Have a second person place wheel chocks on downhill side of left and right trailer wheels.
- Slowly release brake pedal allowing vehicle and trailer to roll into chocks until stopped.
- Using the manual parking brake beside the driver’s seat. Lift the brake lever slightly while pressing the button, then press the lever to the floor.
- Move gear selector lever to position “P”.
- On inclines, turn wheels toward the road curb.

Towing Your Touring Coach

See the Mercedes-Benz Sprinter Operators Manual for towing information.

NOTE

Considerable damage may occur if the touring coach is improperly lifted for towing purposes. Only qualified professional towing service companies with proper equipment should be used. Observe all cautions and warnings in the Mercedes-Benz Sprinter Operator’s Manual before towing your touring coach.

Safety Check List

Your Airstream Touring Coach should be given a thorough safety check before a trip. Regular use of the following list will provide safe operation of your touring coach and will help you spot any malfunctioning equipment and correct the problem as soon as possible. The list is to help you and may not be all-inclusive.



WARNING

Failure to heed the following items may cause damage to the vehicle or personal injury.

Exterior Check List (Before Entering Vehicle)

1. Check condition of tires and keep tires at recommended inflation pressure per the tire and loading placard on the driver’s door B-pillar.
2. Turn off remote LPG valve switch.
3. Check that macerator hose, city water hookup, TV cable/satellite, power cord, and all exterior components are unhooked and properly stowed.
4. Check that all external compartment doors are properly closed, latched and locked.
5. Check that items stored on exterior of vehicle are securely tied down.
6. Verify if any items stored on exterior of vehicle would present a clearance problem.
7. Follow all automotive manufacturer’s recommendations on checking and filling fluid levels.
8. Check exterior lights and general condition of vehicle.

Interior Check List (Before Driving)

1. It is important that all doors be completely closed and locked during travel.
2. Turn off the water pump and close all faucets.
3. Check that refrigerator door is closed and latched if equipped.
4. Check that nothing heavy is stored in overhead or high cabinets, which could fall out and cause injury. Heavy items should be stored in lower cabinets.
5. Stow galley slide shelf and pedestal tables.
6. Check that counter tops, cooktop, and shelves are clear of even small items that could become projectiles during an emergency braking or accident.
7. Latch the shower doors.
8. Do not cook unless the touring coach is parked and stable. Hot food or liquid could scald due to a sudden stop or accident while traveling.
9. Be sure all LPG controls on the appliances are turned off.
10. Check that any internal stowage is securely held in place
11. Check that lights and switches are set in positions safe for travel.
12. Adjust the driver's seat so that you can easily reach and operate all controls. Make sure seat is locked in position. Do not adjust driver's seat swivel or recline mechanisms while vehicle is moving. The seat could move unexpectedly causing loss of control.
13. Check that all passengers have seat belts on properly.
14. The freedom of movement of the brake and accelerator pedals must not be impaired in any way.
15. Check rear view mirrors adjustment, inside and outside. Adjust window coverings if necessary for maximum visibility.
16. Secure children in a federally-approved child restraint device.

AIRSTREAM®

Section 9 MAINTENANCE

MAINTENANCE SCHEDULE	9-2	WINTERIZING AND STORAGE	9-14
SUGGESTED MAINTENANCE AND REPLACEMENT PARTS.	9-3	Touring Coach Winterization	9-14
Exterior Care.	9-4	Component Locations for Winterization	9-14
TIRE CARE	9-5	Instructions for Winterization	9-15
Tire Care Tips	9-5	Optional-Additional Steps for Winterization	9-15
Tire Inspection and Storage	9-5	Water Heater Winterizing	9-16
LITHIUM IRON PHOSPHATE BATTERIES (HOUSE BATTERIES).	9-6	Macerator Pump Winterizing	9-16
Lithium Technology	9-6	Toilet	9-16
Battery Management System (BMS)	9-6	Toilet Winterizing	9-16
Battery State of Charge	9-7	Maintenance	9-17
Cold Weather Usage.	9-7	Restoring Service	9-17
LPG SYSTEM	9-8	Exterior Door.	9-17
LPG Tank Remote Fill	9-8	Lubrication	9-17
Remote Gas Supply Switch	9-8	Adjustments	9-17
LPG Regulator	9-9	ELECTRICAL DIAGRAMS	9-18
Exterior LP Port.	9-9	12-Volt Main Schematic	9-18
PLUMBING	9-10	30-Amp 120-Volt Schematic - USA	9-30
Water System (Self-Contained)	9-10	30-Amp 120-Volt Schematic - Canada	9-31
Water Pump and Strainer	9-10	Audio/Video Schematic	9-32
Sanitizing	9-11	Standard 30-Amp Circuit Breaker Layout	9-33
DRAIN AND WASTE SYSTEM	9-12	SOLAR PANEL WIRING	9-34
Macerator Pump	9-12	MULTIPLEX CONTROLS	9-35
Emptying the Black and Gray Water Holding Tanks.	9-13	Multiplex Circuit Control Board Layout	9-35
Macerator Impeller Release Feature	9-13	Multiplex Networking Diagram and Switch Panel Layout.	9-36
Manual Operation	9-13	FRESH WATER LAYOUT	9-37
Extended Stays	9-14	FAQS AND ANSWERS	9-38
Black Water Tank Flush	9-14		
Drain System Cleaning	9-14		

Maintenance

Maintenance Schedule



WARNING

Failure to maintain your touring coach can cause premature and unexpected parts breakage and/or erratic operation that may be hazardous.

NOTE

See appliance manufacturer's literature for further information.

Every 1,000 miles or 60 days	
Smoke and CO Alarm	Test and replace battery as required.
Tires	Check tire pressure (See Specifications).
GFCI Circuit Breaker	Test and record.

Every 5,000 miles or 90 days	
Door Step	Lubricate and inspect moving parts.
Exterior Latches and Hinges	Lubricate with light household oil.
LPG Regulator	Check bottom vent for obstructions.
Wheel Lug Nuts	Torque wheels to 140 ft. lbs.
7-Way Plug	Spray with contact cleaner.
Exhaust fans	Clean fan blades and wash filter, if supplied

Every 10,000 miles or 6 months	
Tires	Inspect and rotate.
Windows, and Door Seals	Clean with mild detergent and apply 303 Aerospace Protectant
Exterior	Wax

Every year	
Batteries	Check terminals are secured.
LPG Tank	Have purged by LPG supplier.
Seams	Check and reseal exterior seams, windows, lights, and vents as needed.
Interior Cabinets	Visual inspection of latches and locks, hinges and slides. Silicone spray as needed.

Every 100-150 hours	
Generator	Change oil after the first 20 hours of run time.
	Change oil thereafter every 100-150 hours.
To break in the Onan generator run the generator at 50 percent load for two hours, then at 75 percent load for two hours. Refer to the Onan's manual for more details.	

Suggested Maintenance and Replacement Parts

(Part numbers listed are Airstream part numbers and can be ordered by calling a certified Airstream dealer.)



WARNING

Always replace the bulb or light fixture with the correct bulb for that light or matching fixture. Failure to heed this warning could cause fire, property damage, personal injury, or death.

Exterior 12-Volt Lighting – For additional exterior lights refer to your Chassis Owner’s manual.

Grab Handle w/LED Light	PN – 513037
Light w/Motion Sensor & ON/OFF Switch	PN – 513224
Yellow Marker/Clearance Light	PN – 513885
Red Marker/Clearance Light	PN – 513886
Light, 3rd Brake w/Eyeball Camera	PN – 513031
Taillight, RH	PN – 513227
Taillight, LH	PN – 513226

NOTE: Most Exterior Lighting is LED and a replacement fixture will be required.

Interior 12-Volt Lighting

LED Flex Tape Light, 45.63”	PN – 513671-03
LED Flex Tape Light, 53.5”	PN – 513671-04
LED Flex Tape Light, 35.4”	PN – 513743-36
LED Flex Tape Light, 53.1”	PN – 513743-53
LED Flex Tape Light, 23.5”	PN – 513747-23
LED Flex Tape Light, 86.75”	PN – 513747-86
LED Flexible Light w/USB Charge Port	PN – 513330
LED Spot Light w/Frosted Lens	PN – 512987
LED Linear Diffused Light, 68”	PN – 513072
LED Aisle Light, Motion Activated	PN – 513070
Lightbar w/ON/OFF Switch, 16”	PN – 513103

NOTE: Most Interior Lighting is LED and a replacement fixture will be required.

Replacement Breakers - USA Breakers

Breaker, Bryant, 20 Amp	PN – 510564-01
Breaker, Bryant, 30 Amp	PN – 510564-02
Breaker, Bryant, 20-20 Amp	PN – 510564-04
Breaker, Bryant, 15 GFCI Amp	PN – 510564-07
Breaker, Bryant, 20-15 Amp	PN – 510564-08
Breaker, 12V DC Type II, 8 Amp	PN – 510947-08
Breaker, 12V DC Type II, 15 Amp	PN – 510947-15
Breaker, 12V DC Type II, 20 Amp	PN – 510947-20
Breaker, 12V DC Type II, 30 Amp	PN – 510947-30

Replacement Rivets			
Interior			
Part Number	330164	330134-05	325121-03
Rivet Name	MGL100-U6-9	RV6601-0604S	RV6607-6-8
Head Style	Flush Head	Countersunk	Shaveable
Body Diameter (Inches)	0.187 (3/16)	0.205 (3/16)	0.205 (3/16)
Hole Size	0.191-0.201	0.209-0.221	0.209-0.221
Drill Number	NA	4	4
Grip Range In (Inches)	0.305-.500	0.106-0.250	0.050-0.500
Length Under Head (Max. Inches)	0.929	0.935	1.00
Head Diameter (Nominal)	0.345	0.340	0.469
Head Height (Max. Inches)	0.070	0.103	0.094
Typical Sheer Strength (lb)*	1300	675	675
Typical Tensile Strength (lb)*	950	450	450
*Values shown are a guide only and may vary depending upon the application.			

Replacement Filters	
Air Conditioner	PN – 690699-100

Exterior Care

The following exterior care products are recommended by Airstream. Read and follow label directions. Exterior sealant should be checked and resealed once a year.

Walbernize Super Seal (PN - 28433W) - Use to clean and polish while depositing a reflective, water-proof, glaze finish. Recommend two applications a year.

Acryl-R Seam Sealer (PN - 28430W-01 [16 oz can-Gray]) - Use anywhere a fine bead of gray sealant is required.

Acryl-R Seam Sealer (PN - 28430W-04 [16 oz can-White]) - Use anywhere a fine bead of White sealant is required.

Acryl-R Seam Sealer (PN - 28430W-06 [16 oz can-Clear]) - Use anywhere a fine bead of Clear sealant is required.

AdSeal Premium Quality Sealant Adhesive (PN - 365330-01 [10 oz tube-White]) - Use anywhere a thicker bead of White sealant is required.

AdSeal Premium Quality Sealant Adhesive (PN - 365330-02 [10 oz tube-Gray]) - Use anywhere a thicker bead of gray sealant is required.

AdSeal Premium Quality Sealant Adhesive (PN - 365330-04 [10 oz tube-Black]) - Use anywhere a thicker bead of Black sealant is required.

Sikaflex 221 Multi-Purpose Polyurethane Sealant (PN - 360180-04 [10 oz tube-Black]) - Use to seal below the rubrail, or anywhere a thicker bead of black sealant is required.

Touch-up Caulking	
Seam-Fil White	PN – 360301-02
Seam-Fil Black	PN – 360301-04
Seam-Fil Elm	PN – 360301-35
Seam-Fil Drift	PN – 360301-24
Seam-Fil Grey Cedar	PN – 360301-25
Fil-Stik Black	PN – 28431W-01
Fil-Stik Gray	PN – 28431W-02
Fil-Stik White	PN – 28431W-03

Airstream Touch-up Paint Codes	
Arctic White	9147
Iridium Silver (Mercedes)	9775
Jet Black	9040
Obsidian Black	9197

Tire Care

The most important function of tires is to provide traction while moving and grip when steering or stopping. The tires on your touring coach are designed for highway use and must be properly maintained in order to maximize tire life, as well to provide a safe mode of transportation.

Tire Care Tips

To reduce the risk of tire failure, we strongly recommend the following:

1. Check the pressure in your tires at least monthly when the tires are cool (after the vehicle has been stopped for 3 hours and then driven less than 1 mi). Do not reduce pressure when tires are hot. Use a tire gauge to check pressure and maintain it at the recommended level.
2. Never overload your tires. Heed the maximum load-carrying capability of your tires.
3. Check your tires frequently for scrapes, bulges, separations, cuts, or snags resulting from use. See your tire dealer immediately if any such condition is discovered.
4. Never operate your vehicle in excess of lawful speeds, the maximum speeds justified by driving conditions, or in excess of speeds recommended for the tires you are using.
5. Make every effort to avoid running over objects that may damage the tire through impact or cutting, such as chuck holes, glass, metal, etc.
6. Never drive on smooth tires. Tires should be removed when 2/32 in. of tread depth remains. In most states, it is illegal to drive with less than 2/32 in. remaining tread depth.
7. Park out of the sun whenever possible when in warm climates. In desert regions, use tire covers to prevent ultra violet light deterioration to tires.

Tire Inspection and Storage

Before taking your touring coach on a trip or when removing it from an extended storage period, make it a practice to inspect the overall condition of your tires. Check for any type of condition or damage that might result in failure. A thorough check should include both inside and outside sidewalls, tread area, and the condition of hardware such as valve stems, valve caps, and wheels. The tread should be checked for any unusual wear, cracking, penetrations, and/or cuts. An uneven wear pattern can indicate misalignment or worn suspension parts.

Since many touring coach's are used seasonally and sometimes stored for extended times, it is possible that tires will take many years to wear out. Tires, as any rubber product, will age over time. If tires show cracking in the sidewall or tread surfaces that are more than 2/32-in. deep, they should be replaced before your next trip or vacation. Store your touring coach in a cool, dry area away from major heat sources and extreme cold. An enclosed storage area is best with no exposure to electromagnetic sources such as generators or transformers. If you must keep your touring coach outside, cover your tires from direct sunlight. Take your touring coach to your tire dealer for service to check or correct any of these conditions.



WARNING

For safety reasons, the wheel tightening torque must be checked immediately after changing a tire and again after 30 miles to 140 ft-lbs. The wheels could otherwise come loose.

Lithium Iron Phosphate Batteries (House Batteries)



Your Airstream Touring Coach is factory-equipped with two 100Ah 12V LiFePO₄ deep cycle batteries. The house batteries are located under the coach behind the driver's and passenger's step well.

Lithium Technology

Airstream's lithium batteries require no new hardware, or complicated setup, and are a drop-in upgrade. They are designed to outperform traditional lead acid batteries and offer more usable energy. The Lithium batteries have a life span of approximately 3000-5000 cycles. A cycle is determined by a discharge and a charge. How many cycles a lithium battery can sustain is determined by how depleted a battery is discharged, before it is charged. A battery that is only discharged 50% will have more cycles than a battery that is constantly discharged to 0%.

Lithium batteries provide longer life and faster charging than lead acid batteries, while still providing 80% of the rated capacity, after thousands of cycles. If the batteries are completely depleted, it will take approximately 8 hours to charge the 200Ah battery bank, at 25 amps.

Unlike lead acid batteries, which require water replacement, lithium batteries require no active maintenance. The use of lithium batteries in Airstream's Touring Coach, also provides the benefit of delivering more energy at typically half the weight of a traditional battery.

NOTE

An owner's manual for the lithium batteries is provided in the Airstream Owner's Packet. Make sure to read, understand, and follow all information, such as Notes, Cautions, and Warnings, before operating.

Battery Management System (BMS)

A BMS is crucial in ensuring safe operation of any lithium battery. The BMS monitors cell voltages, currents, and temperatures to make sure they are operating in a safe range. The BMS is sealed internally and will shut the battery down should any fault condition occur. The battery will restart once the fault condition is cleared. The following, are features of the BMS:

- Over/under voltage protection
- High current protection/short circuit
- High temperature protection
- Low temperature charging protection
- Cell balancing



CAUTION

Even though the BMS will protect against issues from overcharging, it should be avoided. The recommended specs are 14.4-14.6 bulk/absorb and below 13.6 float.

The BMS will shut the batteries down when the battery voltage drops below approximately 11.5 VDC. When the batteries shut down, due to Low Battery Cut Off (LBCO), both the main battery disconnect switch and inverter power switch will remain in the positions they were in, prior to the batteries shutting down.

To bring the batteries out of LBCO Mode, a voltage of approximately 11 VDC or greater needs to be applied across the battery terminals. There are two ways of doing this:

1. Start and run the vehicle engine. This will provide alternator voltage of approximately 14.5 VDC across the battery terminals and provide a charge current through the DC-DC converter. The DC-DC converter will limit the charge current to the house batteries to approximately 40 amps. This should take approximately 1 minute.
2. Jump the house batteries with an external battery charger (only one battery will need to be jumped).

NOTE

When the inverter/charger display turns on, the vehicles engine can be turned off, if the coach is plugged in or the generator is started. Otherwise, the engine will need to be ran long enough to fully charge the house batteries.

If the coach is not plugged into shore or generator power, to charge the house batteries, the batteries can go back into LBCO Mode soon after the vehicle's engine is turned off. Bringing the batteries out of LBCO Mode is only "waking up" the batteries and allowing them to take a charge. If wanting to use the generator to charge, the vehicle's engine will need to be ran for several minutes before the house batteries are charged enough to start the generator.

NOTE

If the batteries are in LBCO Mode and it is below 35°F, turn the "Battery Heater" switch to "ON" before performing the wake up procedure.

NOTE

The BMS will not allow a charging current if the internal temperature is below 25°F and it will not allow a charging or discharging current above 135°F.

Battery State of Charge

The heated batteries consume an average of 1.8 amps. Testing indicates, that at 0°F, with no insulation, the heater would be on about 30% of the time. With no other loads or charging, the batteries would give approximately 185 hours of heat capability before the batteries would go into LBCO shutdown.

Voltage	Capacity	Amp Hours Remaining
14.4V	100%	200
13.6V	100%	200
13.4V	99%	198
13.3V	90%	180
13.2V	70%	140
13.1V	40%	80
13.0V	30%	60
12.9V	20%	40
12.8V	17%	34
12.5V	14%	28
12.0V	9%	18
10.0V	0%	0

NOTE

Values are based off a testing environment with the batteries at 100% capacity.

Cold Weather Usage

During the winter, lithium batteries will not take a proper charge if the temperature is below 35°F. To help prevent the batteries from reaching these temperatures, an internal heating element has been installed, which will engage when the temperature drops below 35°F, if the key switch is turned ON. The heating element will automatically engage and disengage, depending on the temperature, and does not require any user involvement.

When storing your touring coach, a key switch located in the entry door electronics cabinet, can be used to turn OFF the battery heaters. This will prevent any parasitic battery draws from the heaters, while the coach is in storage.

NOTE

It is recommended that the battery heater's be turned ON if the outside ambient temperature will drop below 35°F.

LPG System

Your touring coach is equipped with a permanently-mounted tank for LPG with a remote fill and remote gas supply shut off switch. LPG burns with a clean blue flame. LPG is used where subfreezing temperatures are common, since it boils at -44°F . Keep in mind at these temperatures the BTU is lower than at 30°F . How long a full tank of gas will last is dependent on usage. In cold weather, when you are using the furnace, using large amounts of hot water, or cooking extensively, you will naturally use more LPG than you will in warm weather, or when doing limited cooking. On the average, with normal cooking and other appliance use, you can probably count on a few weeks of usage from the tank, if you are not running your generator.

If you have allowed the tank to run out, air may have gotten into the lines. In this event the air must be allowed to bleed from the lines before lighting appliances. Follow the appliance manufacturer's instructions and light the appliance closest to the LPG supply tank. Then move to the next closest, etc.

LPG Tank Remote Fill

The LPG tank is filled by accessing the remote fill hookup located in the rear utility compartment on the passenger side. Be sure the fill is free of dirt. It may help to remind your LPG supplier to only use a clean fill hose to fill your tank. Turn off the remote switch when the LPG system is not in use, as it draws 12-volt current from the batteries.



WARNING

Only certified LPG suppliers should fill the LPG tank. Turn remote gas supply switch off before filling or refilling LPG tank.



WARNING

Always shut off the LPG gas when refueling the touring coach.

Remote Gas Supply Switch



A remote switch for shutting off the gas to all appliances is located in the curbside rear utility compartment. The switch activates an electric solenoid which opens and closes, shutting the gas off at the tank. This switch should be turned off during the filling of the LPG tank or when LP is not needed to fuel appliances.

Gas lines should be checked periodically for leaks with ammonia-free soapy water.



WARNING

Be careful when working around electricity, as it can carry dangerous amperage and cause sparks or combustion.

NOTE

The electric gas shut-off solenoid closes automatically when 12-volt power is disconnected. It will reopen when power is restored.



WARNING

All LP gas appliances must be turned off during refueling of touring coach fuel tanks and permanently-mounted LPG tank.



WARNING

Do not use open flame to search for problems. If gas can be smelled, appliance pilots fail to stay on, or any other abnormal situation occurs, use the remote supply switch to shut off the tank valve immediately and call on a qualified LPG service center or Airstream Service Center.

LPG Regulator

The LPG regulators used on Airstream Touring Coach's are designed for low-pressure service, with a normal outlet pressure setting of 11"-14" water column. Only personnel trained in the proper procedures, codes, standards, etc., should service regulators. Have the regulator inspected each time the tank is refilled. Replace any regulator that has had water in the spring case, or shows evidence of external corrosion or corrosion inside the spring case.



CAUTION

Moisture in the LPG tank will cause a malfunction of the regulator in controlling proper pressure. This may result in the flame lifting off the burner or going out frequently. Many refueling stations will add approximately ¼ to ½ gal of alcohol allowing moisture to pass through the regulator without the formation of ice crystals.

Exterior LP Port

A quick-connect, low-pressure LPG connection is located under the passenger side rear quarter panel behind the dual wheels. It is a utility connection for use of an outside grill or other LPG appliance. Check that the remote LPG shut off switch is turned off. Slide the collar on the female end back and plug the male hose into the connection. Release the collar and check that the hose is properly connected by giving a firm pull on the hose. Turn the LPG remote shut off switch on and recheck all connections to the appliances and quick connection to be sure no leaks are present. Follow all instructions, cautions, and warnings in this manual when connecting and disconnecting appliances.

Plumbing

Water System (Self-Contained)

The fresh water system consists of a city water hookup, fresh water tank and drain valve, water pump, hot and cold water lines, water heater, and faucets. Full explanations on the locations and use of these features are explained in this section.

Before using the water system, check that the water heater bypass valve is turned to the use position. The bypass valve is located under the galley in the upper right hand corner, accessed by removing the galley drawers. See Winterizing and Storage for further information on the bypass. Make sure the fresh water tank drain valve is closed.

The water tank can be filled by connecting a potable water hose to the city water inlet and turning on the fresh water valve switch. A high-pressure RV/Marine FDA approved drinking water hose of at least ½-in. diameter made from material that is tasteless, odorless, and non-toxic should be used. It's a good idea to let the water run through the hose for a short time to flush it out. RVers sometimes fill their tanks with "home" water to avoid strange water that may be distasteful to them on short outings. Remember, the more water you carry in the Fresh Water tank, the less cargo carrying capacity you have for other items. The amount of water in the tank may be checked on the Multiplex Control Panel. The fresh water valve switch will automatically turn off when the tank is full.

Because the water heater is tankless it does not need to be filled. However, if the system has not been used for some time or is being used for the first time since draining the lines it is normal for air to have gotten into the lines. To expel the air, open the hot side of either the galley, wet-bath, or exterior shower faucet and turn on the water pump or connect to an exterior city water source. Close the cold side of all faucets. For some time the open faucet will only sputter. This is because the air is being pushed out through the lines. Once the air is expelled, a steady stream of water will come from the faucet.

Now, open a cold faucet. It will sputter for a short time, but will soon expel a steady stream. All other faucets can now be opened until all air is expelled.

Once the system is filled with water and the faucets are closed, the water pump will shut off. When a faucet is opened, the pump will come back on automatically. If the faucet is just barely open, it is normal for the pump to cycle on and off rapidly.

It is normal for a pump to occasionally cycle when all faucets are off to keep the water pressure at the set point. However, if it cycles frequently (e.g. more than a few times an hour) the plumbing system, pump, and pump strainer should be checked to be sure it is not losing pressure through a slow water leak or back through the pump.

NOTE

To prevent equipment damage, the water heater should only be started after the water system is primed and ready for use.

NOTE

Turn the water pump off when the touring coach is left unattended or while driving.

Water Pump and Strainer

The water pump is controlled by the main Multiplex control panel or the panel located in the galley. Once the switch is turned on, the pump will run until the water pressure reaches approximately 55 psi. At this point, an internal pressure switch will shut it off. When a faucet is opened, the water pressure will drop and the pump will start to run again.

As a general rule, the water pump should be turned off while using a city water hookup; however, the water pressure at some campgrounds may be low. The water pump can be turned on to assist the city water hookup pressure. Be sure there is some water in the fresh water tank. The pump will only use the water that is needed out of the tank to bring the pressure up to the usual standard of 55 psi.

The water pump and strainer are located under the bathroom sink, accessed by opening the doors and removing the back panel. The strainer should be visually checked for accumulation of sand or debris that could affect water flow.

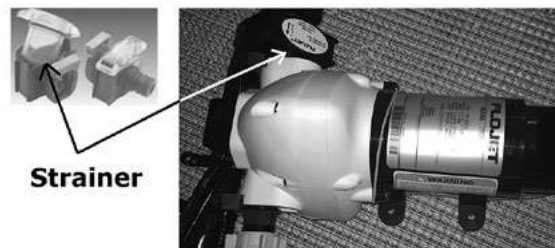

To clean the strainer screen: With the clear plastic at the top, press on the sides of the strainer releasing the tabs holding the clear plastic top in place, hold the sides in, and pull straight up on the clear plastic top to

remove the screen assembly. Rinse all debris from the screen. Replace the screen assembly by aligning the screen in the seating grooves and pressing gently down until the tabs catch and hold the clear plastic top in place.

The inlet and outlet hoses and the strainer assembly are held in place by self-sealing, blue, quick-connect fittings. To disconnect a hose or the strainer, grasp the blue tab on the female fitting by the grooved finger edges and pull straight out on the tab. This will release the male fitting connected to the hoses and strainer. Be sure that both the female and male fitting on the disconnect are free of all debris and are not damaged before replacing. Check the pump system for leaks any time the disconnect fittings on the hoses and/or strainer are removed.

CAUTION

Failure to check the quick disconnect fitting for water leaks when reinstalling inlet and outlet hoses or the water pump strainer may cause the pump system to leak, causing damage to personal property.

Sanitizing

Potable water systems require periodic maintenance to deliver a consistent flow of fresh water. Airstream recommends sanitizing before and after storage, after new component installation, and if the system is contaminated. When determining how often to sanitize the system, consider environmental factors, usage, and the quality and taste of the water coming out of the system.

Decide whether you want to use an RV fresh water cleaner & deodorizer or a mixture of bleach and water. The following instructions are for the use of bleach. If using an RV fresh water cleaner and deodorizer, follow the instructions on the container for mixture and contact time, and use the instructions below to introduce the solution into the system.

Gather the following supplies ahead of time:

- RV fresh water cleaner & deodorizer; or bleach
- Container(s) suitable for potable water

For the following procedures, you will need to know how many ounces of bleach to add to your bleach/water mixture. Multiply “gallons needed” by 0.13; the result is the ounces of bleach needed. To reduce the amount of time it takes to disinfect the tank from four hours to one hour, double the ounces of bleach.

1. Mix 2-3 gallons of bleach/water solution using the guidelines above.
2. Locate the Sanitization Kit behind/under the galley drawers, uncoil the hose, and insert it to the bottom of the sanitization fluid container.

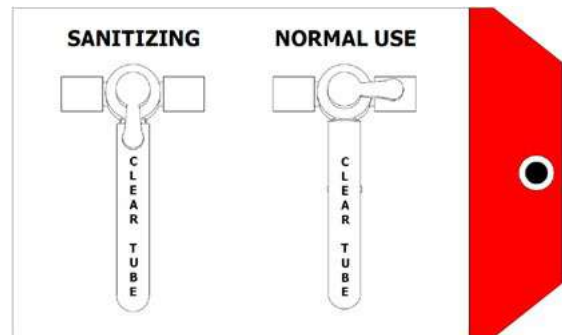

3. Turn the valve from NORMAL USE to SANITIZING (as shown above).
4. OPEN all faucets (hot and cold).
5. Turn the water pump ON and run it until the mixture starts coming out of the faucets and the odor of chlorine is detected. Once the solution is running from the taps you can start closing them. Move from one fixture to the next, shutting them off as you go until all the lines are full. Turn the pump off as you empty and transition from one container to the next.
6. Turn the pump OFF and leave the solution in the system for 4 hours of contact time to complete the disinfection process. Or, if doubling the bleach concentration, 1 hour.
7. Connect to a city water supply and allow the faucets to run until the bleach/water solution is flushed from the system.

NOTE

The sanitizing procedure outlined above is in conformance with the approved procedures of RVIA ANSI A 119.2 and the U.S. Public Health Service.

Drain and Waste System

Your touring coach has a drain and waste system that includes waste-holding tanks made from corrosion-free, molded plastic, with trouble-free dump valves.

The main (Black Water) holding tank enables you to use the toilet for several days away from disposal facilities. The waste water from the sinks and shower, drain into the auxiliary (Gray Water) holding tank.

Each tank has its own dump valve with both tanks draining through a common outlet. Therefore, only one sewer hose connection is needed when hooking up to a dump station.

Almost all campgrounds will have dumping facilities. Park directories, such as Woodalls and Rand McNally, also list dumping stations. Furthermore, the navigation systems GPS can be used to locate nearby dumping stations or highlight stations along your route.

Check your monitor panel frequently (main Multiplex control panel or Seelevel monitor). When the Black Water holding tank is completely full, sewage cannot be emptied from the toilet bowl. If the Gray Water holding tank is overfilled, drain water will back up into the shower floor pan and cause an unpleasant cleaning job. Never drain the tanks at any place other than an approved dumping station.

NOTE

Never put wet strength paper towels or tissues in your holding tank since they will not dissolve and can catch in the mechanism of the dump valve. Colored toilet tissue is slower to dissolve than white. Most motorhome accessory stores offer tissue designed for RV's that will completely dissolve.

Macerator Pump

The waste pump is the ideal solution for emptying holding tanks on touring coach's. The macerator section grinds waste down to a particle size of 1/8-in. maximum. The waste pump will macerate and pump all waste and tissue normally found in recreational vehicle waste systems.



CAUTION

The waste hose is pressurized when operating the macerator pump. Secure the loose hose end at the disposal facility with supplied inlet adaptors before turning on pump.

The high-pressure waste hose is stored on an electric hose reel and connected to the Discharge Port Adaptor. It has a threaded, drip-proof valve with a versatile, two-size, threaded adaptor allowing the valve to be connected to 3 sizes of threaded inlets, including an exterior home sewer clean-out. The adaptor snaps over the valve threads. A rubber ring is also provided to lodge into a non-threaded inlet. If the rubber ring seems loose when used, Airstream recommends using some type of weight to further secure the hose.

Each holding tank, the macerator pump, and macerator pump electric hose reel have individual switches which are located in the roadside rear utility compartment. Each valve switch has a light that illuminates to let you know the valve is opened. Pressing a dump valve switch and holding it for 2-3 seconds until it is lit opens a holding tank valve. Pressing it again for 2-3 seconds closes it. The macerator pump has an ON/OFF toggle switch. The reel has a switch for releasing and retracting the hose, once the hose is released it is deployed manually by pulling the hose out. To retract the hose, press and hold the retract button while guiding the hose back and forth onto the reel evenly.

NOTE

Do not run Macerator pump more than 15 minutes continuously. Do not run the Macerator pump dry for more than 30 seconds. THE MACERATOR WILL NOT HANDLE HARD SOLID OBJECTS, SANITARY NAPKINS OR RAGS. Never put wet strength paper towels, tissues, or sanitary napkins in your holding tank. They will not dissolve and will jam the mechanism of the dump valve and the macerator pump impeller.

Emptying the Black and Gray Water Holding Tanks



1. Remove the high pressure waste hose by opening the hose reel compartment door and momentarily pressing the “release” switch. Once released, the hose can be manually pulled out. Secure the hose at the disposal facility inlet using the threaded or rubber adaptor and open the drip proof valve on the end of the hose.



The pressure from the macerator pump may push the hose from the inlet if the hose is not secured properly.

2. Open the Black Water valve. Empty the Black Water tank first and the Gray Water tank second, using the Gray Water to help flush the pump and hose of Black Water sewage.
3. Turn on macerator pump to liquefy and pump out the solids in the tank.
4. When the black tank is empty, turn off the pump.
5. Open the Gray Water tank valve and turn on the pump. Run until just before the pump runs dry. Any trickle of gray water left will remain in discharge hose behind drip proof valve and is typical. Remember, running the pump dry for more than 30 seconds could damage the pump.
6. Turn the drip-proof valve off and remove the hose adaptor from the dump station inlet. Retract the hose into the hose reel by holding the switch in the “retract” position. Be sure to guide the hose back and forth onto the reel evenly. Close the compartment door.

NOTE

Watch all connections while dumping. Close dump valve immediately, turn off pump, and close hose drip-proof valve if a leak is noticed.

Macerator Impeller Release Feature

Impeller Release Feature

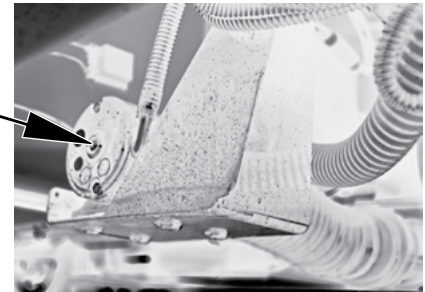

After long periods of non-use, a stuck impeller can be easily broken loose with a screwdriver inserted in the motor shaft slot. Remove the rubber boot, turn the shaft clockwise, and replace the rubber boot. The impeller can usually be found under the touring coach, near the macerator hose reel.

Manual Operation

In case the electric dump valves fail to open, manually pull/push the arm once, to open and close the valve. The manual arm located under the vehicle, near the macerator hose reel.



Extended Stays

When you are in a park with a disposal facility, empty the tanks every few days or whenever they become almost full. Pumping a large volume of liquid through the tanks at a time will keep toilet paper and other solids completely washed away. Remember to empty the Black Water tank first and then the Gray Water tank using the Gray Water to flush the system. This practice will avoid the accumulation of solids in the tank, which could lead to an unpleasant cleaning job.

Should solids accumulate, fill the tank about half full with water using the black tank flush inlet, and then drive the touring coach for a few miles. The turbulence and surging of the water will usually dissolve the solids into a suspension so the tank can be drained. Draining the tanks as described will protect them from freezing during storage.

Black Water Tank Flush



Inside the macerator hose reel utility compartment is a water hose connector for the “black tank flush.” To use, hook up a garden hose and turn it on. Within the tank, a head with multiple holes will spray the interior surface of the tank. Once the tank is about half full, turn the garden hose off and flush the water from the tank using the macerator pump. The gate valve should be closed for the first couple of minutes, and then opened to let the water out in a rush. Repeat as needed. It is recommended the black tank flush be used every time the black tank is emptied or the holes on the spray head may become clogged.

Drain System Cleaning

The only cleaning agents that can be used without causing harm to the system are household ammonia and tri-sodium phosphate in small quantities. Do not use any product that contains any portion of petroleum distillates. This type of product will attack the rubber seals of your toilet and dump valve. Also, do not use any dish detergent or abrasive cleaners. All products should be marked as approved for ABS drainage systems.

Winterizing and Storage

When storing your touring coach, use the same precautions as you would in your own home in regard to perishables, ventilation, winterizing, and rain protection. In addition, for prolonged storage periods, flush out all the drain lines and waste holding tanks. Also, drain the entire water system, including the water heater and the fresh water tank. Instructions for draining the water system are explained in the following paragraphs on winterizing.

Twice a year, or after a long storage period, we suggest you take your unit into your Airstream dealer for a check-up and cleaning of the gas-operated appliances.

The main consideration in winterizing is to guard against freezing damage to the fresh water lines, the waste drain lines, the waste holding tanks, the water heater, and the batteries.

NOTE

Sprinter recommends disconnecting the current to all chassis electric consumers using the engine battery disconnect cable if the vehicle sits for periods longer than 30 days. This will save jump starts, battery charge ups, and possible battery damage and replacement. The Mercedes-Benz Sprinter Operator’s Manual describes its location, operation, and cautions in detail.

NOTE

In very cold weather, winterizing the motor coach is recommended to prevent damage to the waste systems.

Touring Coach Winterization

To perform these steps, you will need an adapter with an air regulator to connect an air compressor to the city water inlet, and access to an air compressor. Adapters are available at most RV stores.

Component Locations for Winterization

Fresh water tank drain valve - under the touring coach; in front of the roadside wheels.

Water heater drain valve - on the water heater; under the galley, accessed by removing the galley drawers.

Water heater bypass valve - on the water line connected to the water heater.

Water pump - under the bathroom sink, accessed by opening the doors and removing the back panel.

Winterization kit - under the bathroom sink, accessed by opening the doors and removing the back panel.

Instructions for Winterization

1. Level the touring coach from side to side and front to rear, turn the water pump OFF, and disconnect the city water.
2. OPEN all the hot and cold water faucets.
3. OPEN the fresh water tank drain valve.
4. OPEN the water heater drain valve.
5. Allow all water to stop draining and proceed to the next step.
6. For this step, you will need someone to operate the toilet foot pedal/flush valve. Using the air compressor, apply at MAX 30 PSI of air pressure at the city water inlet until no water remains in the system. Operate the foot pedal on the toilet. You may need to depress the pedal a few times to work out all the water by allowing some air pressure to build up between flushing. Once all the water has been blown from the system, disconnect the air and continue to the next step.



WARNING

Do NOT exceed MAX 30 PSI when using compressed air to clear the system of water during winterization. Higher pressures may damage the water heater.

NOTE

The MAX 30 PSI can be increased to a MAX 50 PSI if the water heater bypass valve has been set to its bypass position. CAUTION - if 30 PSI is exceeded with the bypass valve in the normal use position, the water heater could be damaged.

7. For this step, have a catch pan or a towel ready to place under the water pump outlet to prevent water from running out into the touring coach. Remove the quick-connect outlet fitting from the water pump. Turn the pump ON briefly to remove any remaining water from the pump head and lines running from the tank.
8. Check the water pump strainer to be sure no water remains.
9. If you plan to add RV antifreeze using the optional steps below, RECONNECT the water pump. Otherwise, leave the fittings from the pump disconnected until the system is ready to be used again. Best practice: leave a note as a reminder near the multiplex panel that the water pump is disconnected.

10. If you plan to add RV antifreeze using the optional procedure below, save this step for the end. Otherwise, for best practice: REMOVE the house batteries from your touring coach and store them in a cool, dry place where there is no danger of freezing. During extended storage periods, especially in cold weather conditions, check the batteries periodically and keep them fully charged for optimal life. If the storage period is 30 days or less, you can turn off the battery disconnect switch rather than remove the batteries.

Optional-Additional Steps for Winterization

An additional step to winterization is to consider adding a non-toxic RV antifreeze (approved for drinking water systems) to the water lines using the Winterization Kit to draw RV antifreeze into the water system, using the water pump.

Before beginning, read the RV antifreeze manufacturer's label for instructions specific to the antifreeze you plan to use. It may take a few gallons to fill the entire system so prepare accordingly. As you follow these steps, it will be helpful to have another person watching and operating the faucets, shower heads and toilet valve.

1. RECONNECT all lines and CLOSE all drain valves.
2. OPEN the sink and shower drains if they are closed.
3. Ensure all the water faucets and shower heads, hot and cold, internal and external, are OPEN.
4. Locate the Winterization Kit under the bathroom sink behind the access panel, uncoil the hose, and insert it to the bottom of the RV antifreeze fluid container.

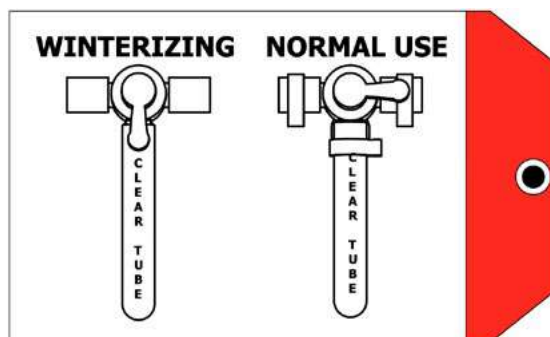

5. Turn the valve from NORMAL USE to WINTERIZE (as shown above).
6. Turn the water pump ON and run it until antifreeze starts coming out of the faucets. Once antifreeze is running from the taps you can start closing them.

Maintenance

Move from one fixture to the next, shutting them off as you go until all the lines are full. Turn the pump OFF as you empty and transition from one antifreeze container to the next.

7. Allow the antifreeze to flow down drains. Flush the toilet and allow antifreeze to flow down the toilet. If equipped, operate the toilet hand sprayer until antifreeze is coming out. If equipped, work the hand shower sprayer while holding it down in the shower until antifreeze is coming out, and do the same with the external shower head. Dump any remaining small amounts of antifreeze down a drain.
8. Shut the water pump OFF once all the lines are full.
9. OPEN all the faucets and leave them open.
10. DISCONNECT the hose, rinse it out with fresh water and store.



WARNING

Remove all RV antifreeze spillage from all sinks, drain pans, and faucet parts after winterizing. Failure to do so could damage surface finishes. Do not use water to rinse antifreeze down the drain as it will dilute the antifreeze.

11. Complete step 10 from the previous set of instructions on winterization.

Water Heater Winterizing

If the touring coach is to be stored during winter months, the water heater system must be drained to prevent damage from freezing. Once drained RV non-toxic antifreeze can be added.

1. Turn off electrical power to water heater by using the on control center or by removing the fuse.
2. Shut off gas supply to water heater.
3. Turn off water pump.
4. Open both hot and cold water faucets.
5. Remove service panel to access system drain valve. The water heater is located under the galley and accessed by removing the galley drawers.



6. Turn drain valve knob clockwise to drain and then clockwise again to close.
7. Follow the Winterizing and Storage instructions for draining entire water system.

NOTE

System will have to be refilled with water and all air removed from lines before unit will re-light.

Macerator Pump Winterizing

Plan your winterizing and storage ahead, and be sure the holding tanks are drained and flushed thoroughly. This is very important, as the frozen sewage and water could seriously damage the system. After dumping tanks, add RV, non-toxic antifreeze to one of the holding tanks and start the macerator pump. Run the pump until the RV, non-toxic antifreeze comes out the end of the pump hose, then close the dump valve. As extra protection, open the toilet valve and add RV, non-toxic antifreeze through the toilet into the Black Water tank and pour RV, non-toxic antifreeze into a sink drain to protect the holding tanks, valves, and pump from residual water freezing.

Toilet

Toilet Winterizing

Draining Method: Turn off the touring coach's water supply. Drain toilet bowl. Disconnect supply line at water valve. Completely drain the toilet's water supply line.

NOTE

To avoid damage when using air pressure to blow water from the lines, make sure the toilet valve is in the open position.

NOTE

If water is frozen in the toilet, do not attempt to flush until the ice thaws. Never use automotive type antifreeze.

Maintenance

If the bowl-sealing blade does not operate freely after extended use, it may be restored to its original, smooth operating condition by applying a light film of silicone spray to the blade. To clean the toilet use SeaLand® Toilet Bowl Cleaner or any other high grade, non-abrasive cleaner. Do not use highly concentrated or high acid content household cleaners. They may damage the rubber seals.

Troubleshooting

1. Leaks:
 - a. Back of toilet: check water supply line connection at water valve. Secure or tighten as necessary. If leak persists from water valve, replace.
 - b. Vacuum breaker leaks while flushing: make sure vacuum breaker stem is pushed fully into sealing grommet in back of bowl. If leak continues replace vacuum breaker.
 - c. Between closet flange and toilet: check flange nuts for tightness. If leak continues, remove toilet and check flange height. Replace flange seal.
2. Toilet won't hold water:
 - a. Check for and remove any debris from blade-ball seal track.
 - b. Check blade/ball seal compression mechanism. If blade/ball seal is worn, replace.
3. Harder than normal pedal operation: Apply light film of Thetford Toilet Seal Lubricant & Conditioner or silicone spray to blade/ball. (Note: To avoid damage, do not use spray lubricants other than silicone.)
4. Poor flush: The pedal must be held completely down to flush. A good flush should be obtained within 2 to 3 seconds. If problem persists, remove the water supply line and check flow rate.

Restoring Service

1. Re-install the fully charged house batteries.
2. Close the holding tank dump valve, water faucets, and fresh water tank drain.
3. Reconnect water pump line.
4. Add water to the fresh water tank.
5. Turn the water pump on.
6. Open and close faucet valves one at a time until water runs clear at all faucets signaling RV, non-toxic antifreeze is flushed out of lines. Go back and recheck water clarity at all faucets.
7. Turn off the water pump.
8. Hook up city water, open faucet valves, and recheck water clarity.
9. Close water heater drain valve and reset water heater bypass valve to normal operating position.

Exterior Door**Lubrication**

Apply a little paraffin or grease to the striker pockets and a slight amount of household oil to the lock mechanisms to keep the locks operating smoothly. Also, lubricate the hinge pins periodically with household oil. Use the lubricant sparingly and remove any excess immediately.

Adjustments

Door adjustments can be affected by:

- The coach being improperly leveled.
- Striker bolt alignment being out of adjustment, (striker bolt is adjustable).

When using the stabilizers (for eliminating movement-not leveling) on your Airstream be sure to check the fit of your door before and after extending stabilizers. The fit of the door can be affected if the coach is not level side to side and front to back.

Electrical Diagrams

12-Volt Main Schematic

This document and the information contained within are confidential and proprietary to Airstream, Inc. and shall not be copied, distributed or used in whole or in part without express written consent.

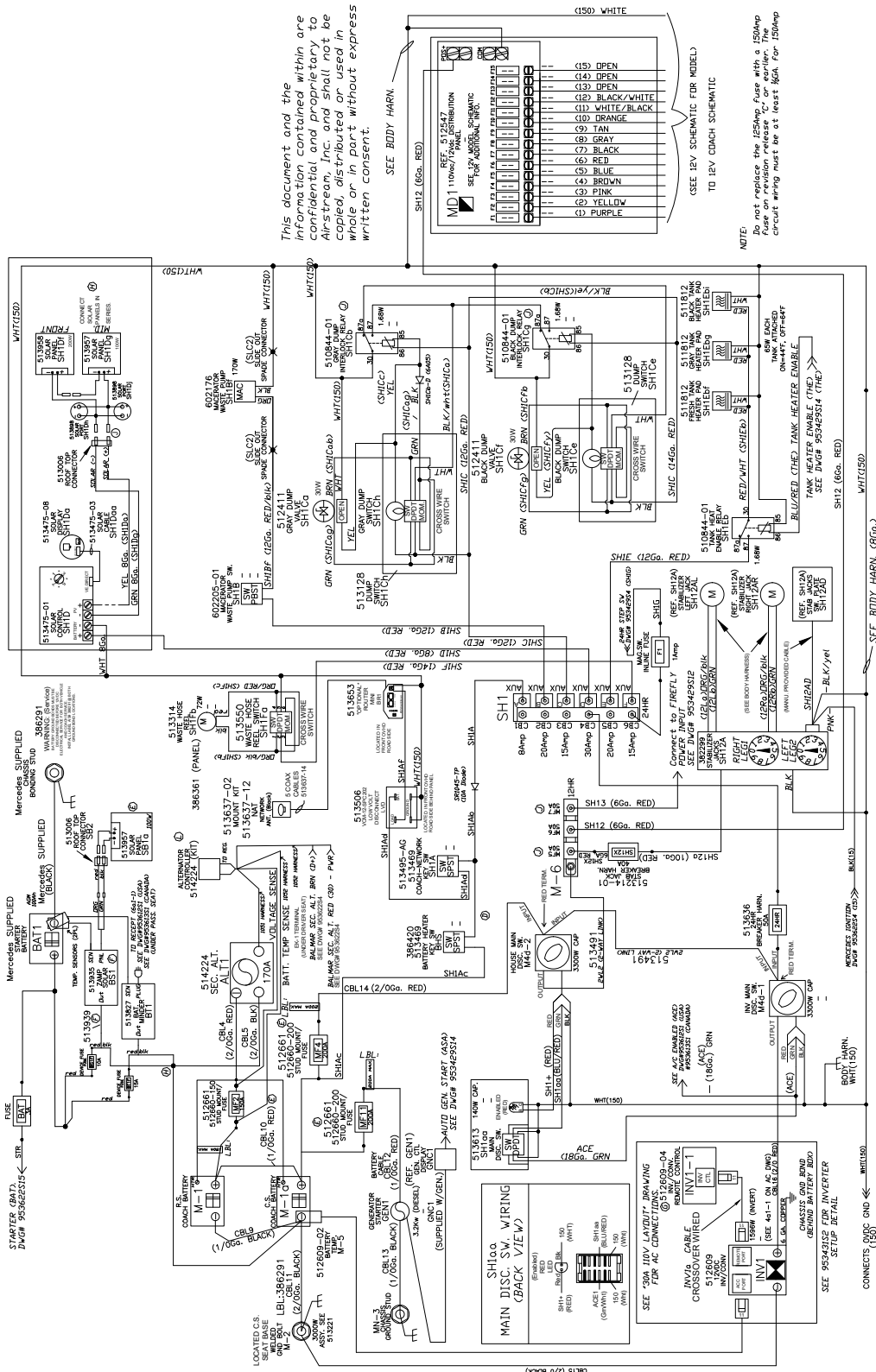

12-Volt Schematic

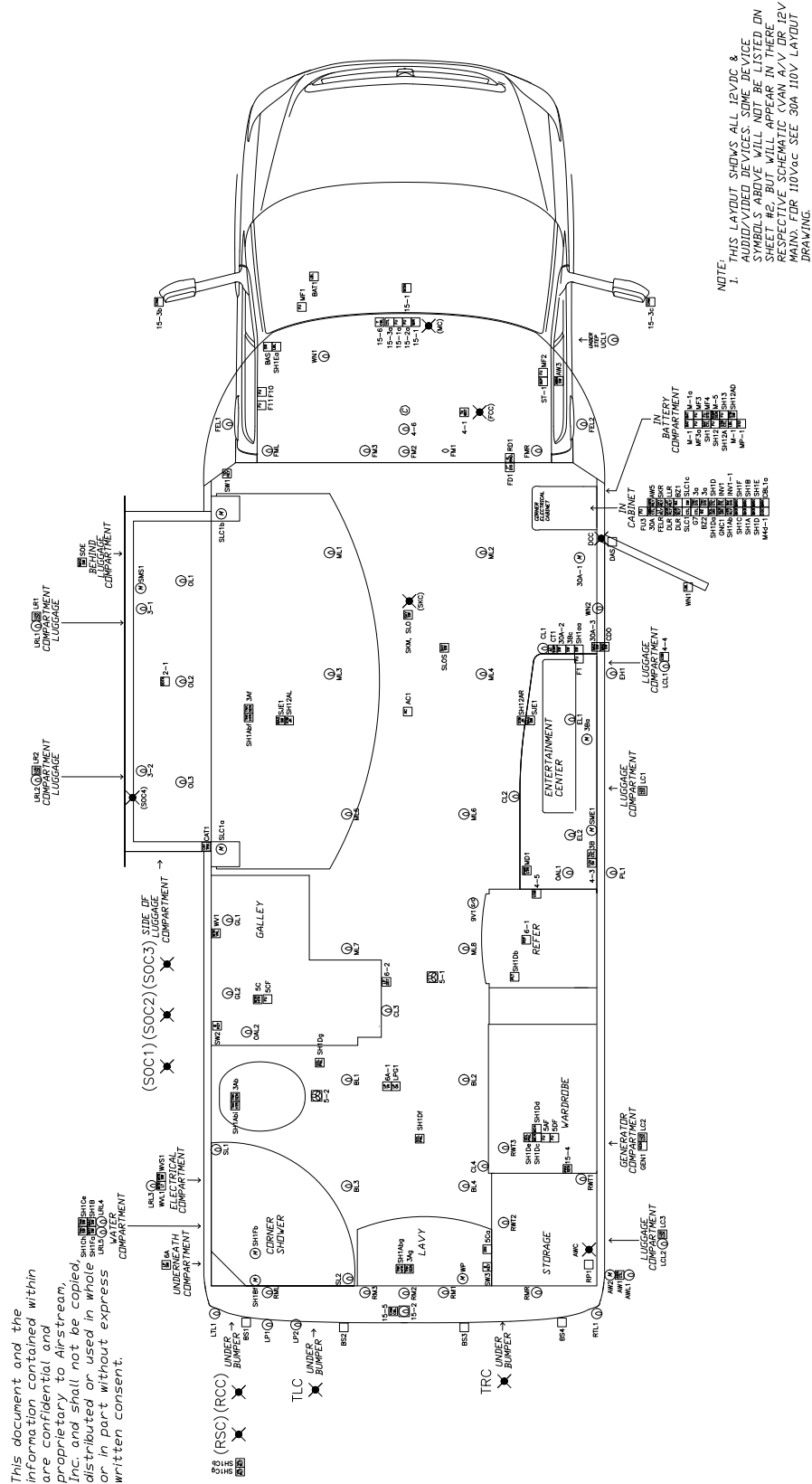

This document and the information contained within are confidential and proprietary to Allstream, Inc. and shall not be copied, distributed or used in whole or in part without express written consent.

12-Volt Schematic

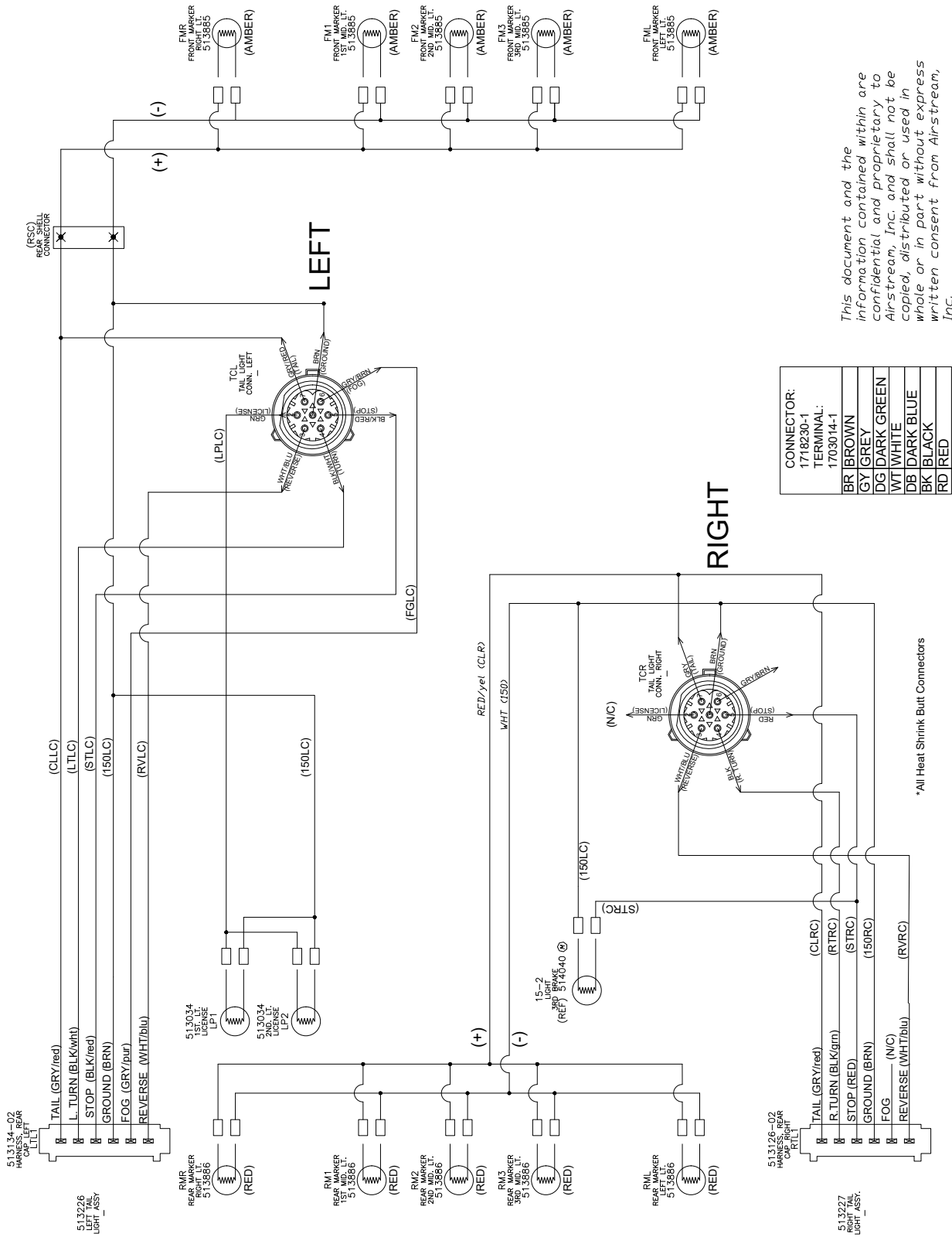

This document and the information contained within are confidential and proprietary to Airstream, Inc. and shall not be copied, distributed or used in whole or in part without express written consent from Airstream, Inc.

12-Volt Schematic

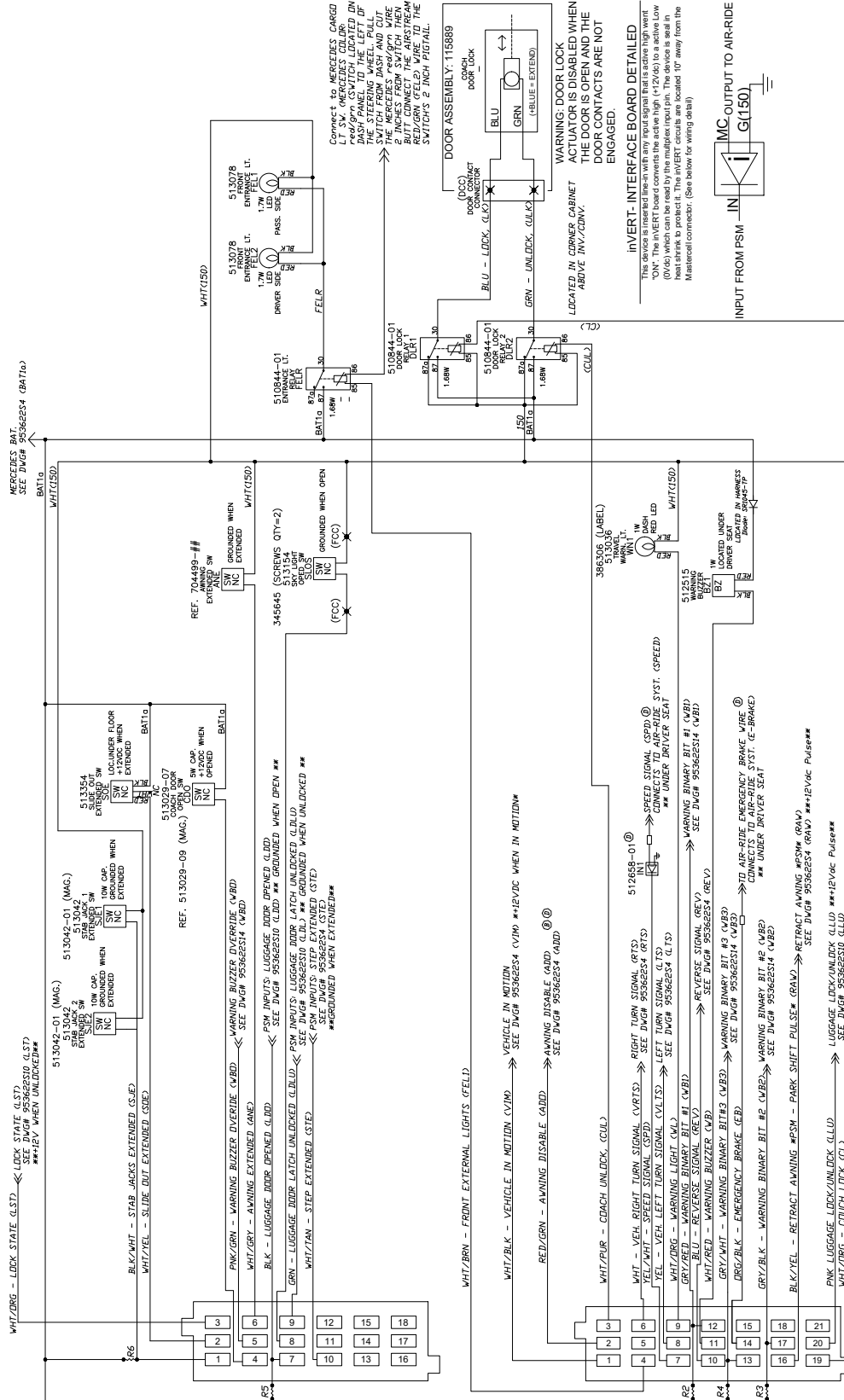

* SCHEMATIC ONLY SHOWS GENERAL WIRE CONNECTIONS NOT ACTUAL WIRE ROUTING. SEE HARNESS DRAWINGS FOR ROUTING.

Note:
Four pull up resistors (10K ohm 5% 1/4W) located in the Body harness. Ref.:(R2, R3, R4, R5)

12-Volt Schematic

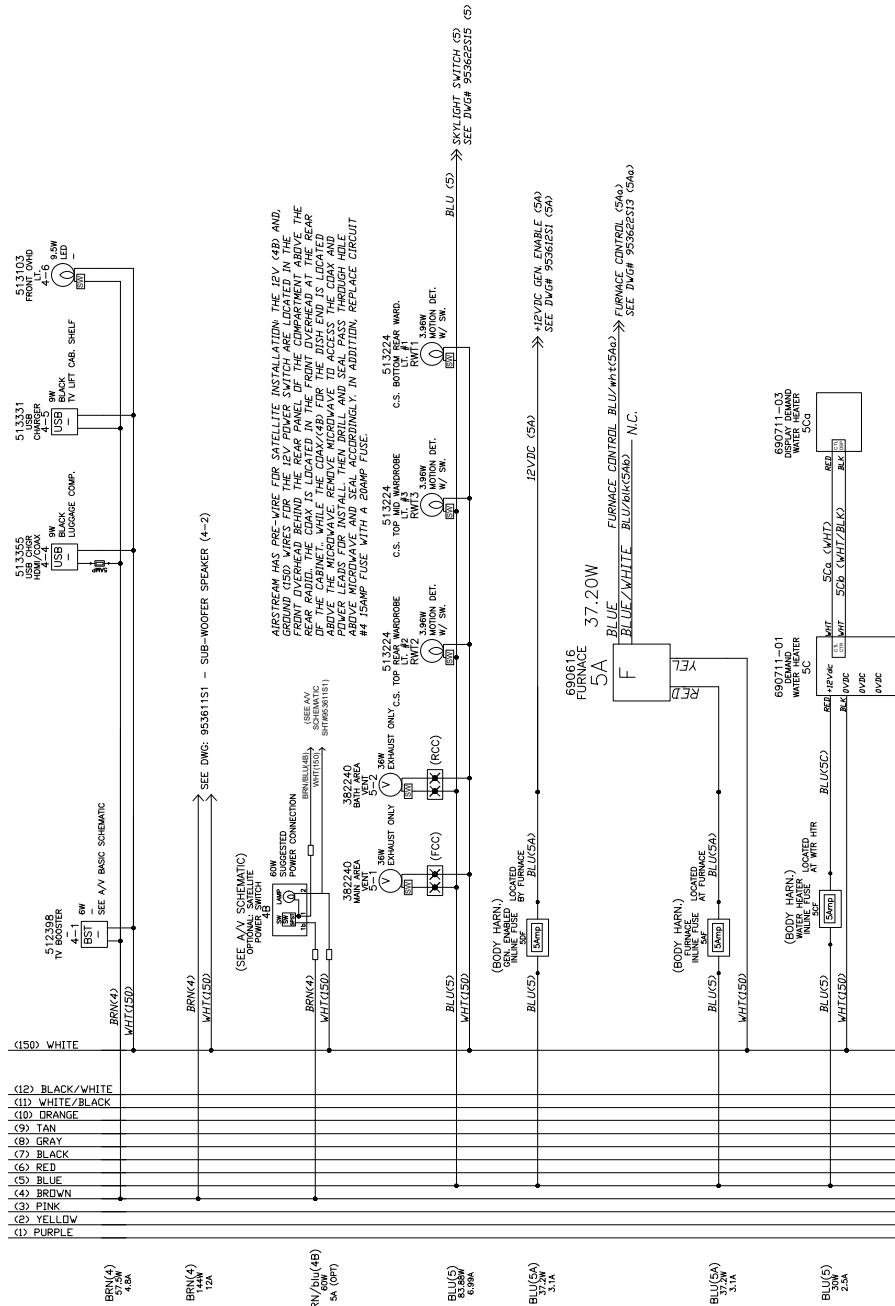

* SCHEMATIC ONLY SHOWS GENERAL WIRE CONNECTIONS NOT ACTUAL WIRE ROUTING. SEE HARNESS DRAWINGS FOR ROUTING.

This document and the information contained within are confidential and proprietary to Alstrom, Inc. and shall not be copied, distributed, used in whole or in part without express written consent.

12-Volt Schematic

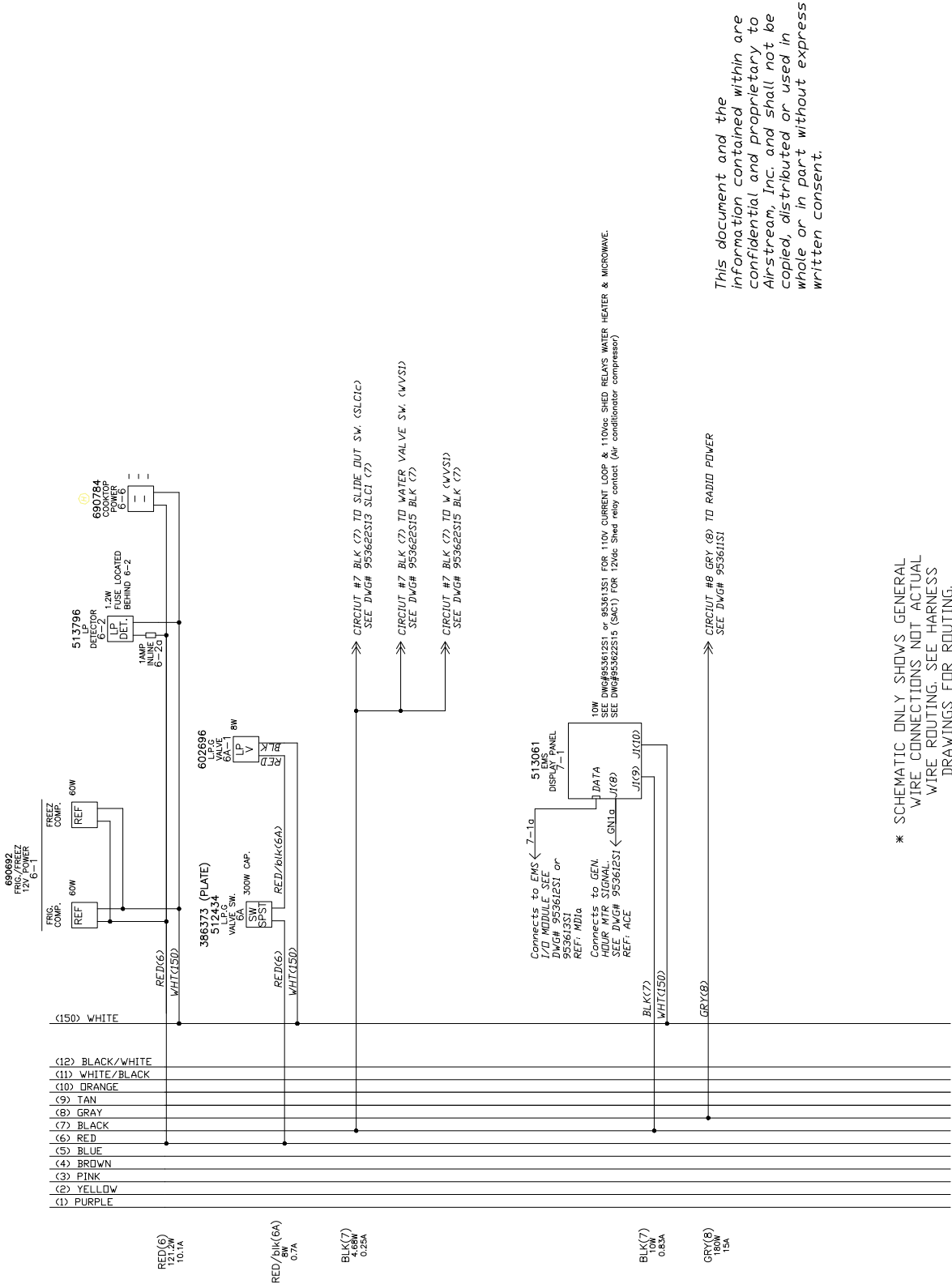

This document and the information contained within are confidential and proprietary to Air-Stream, Inc. and shall not be copied, distributed or used in whole or in part without express written consent.

* SCHEMATIC ONLY SHOWS GENERAL WIRE CONNECTIONS NOT ACTUAL WIRE ROUTING. SEE HARNESS DRAWINGS FOR ROUTING.

12-Volt Schematic

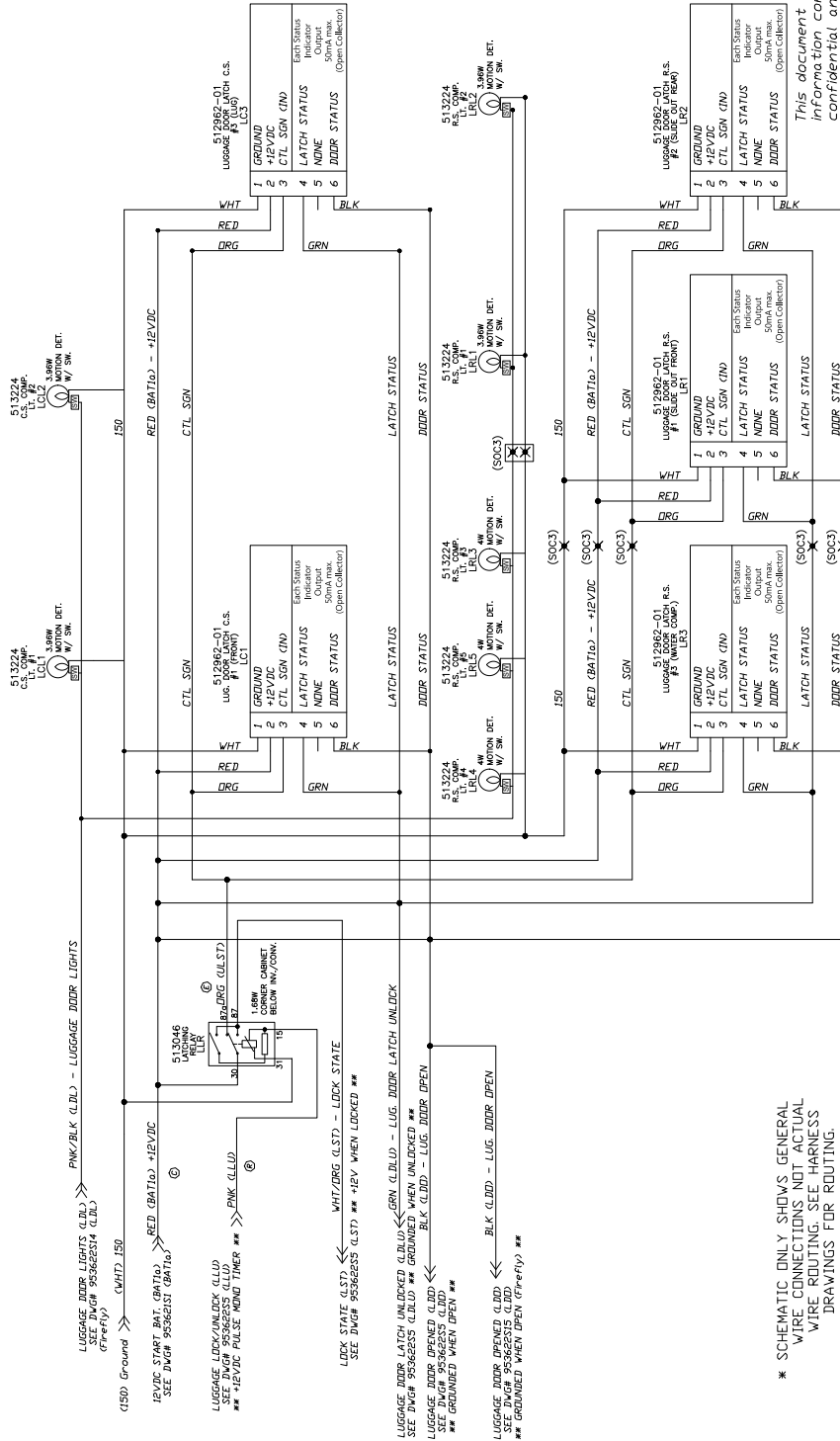

This document and the information contained within are confidential and proprietary to Air-Stream, Inc. and shall not be copied, distributed or used in whole or in part without express written consent.

12-Volt Schematic

This document and the information contained within are confidential and proprietary to Air-Stream, Inc. and shall not be copied, distributed or used in whole or in part without express written consent.

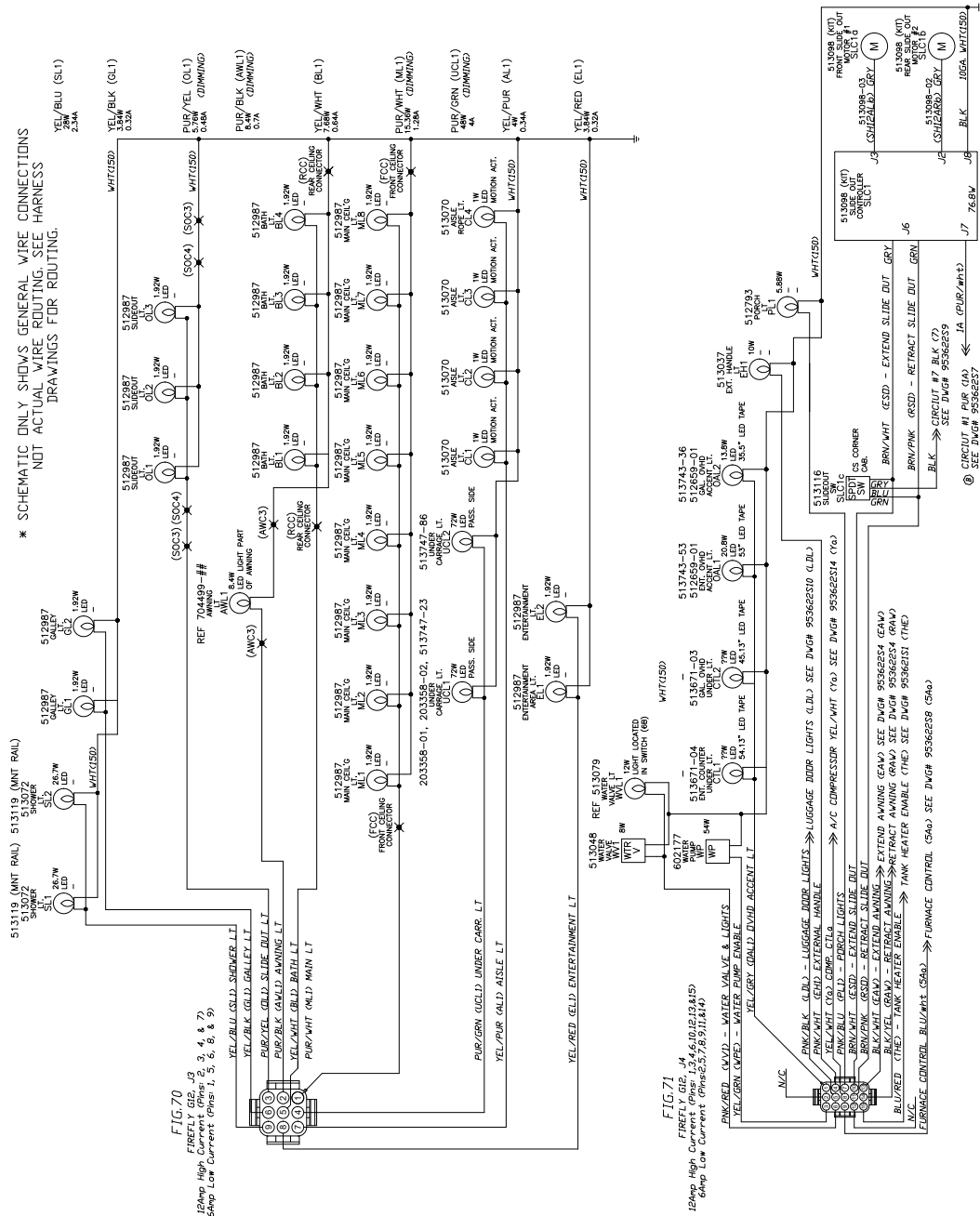

12-Volt Schematic

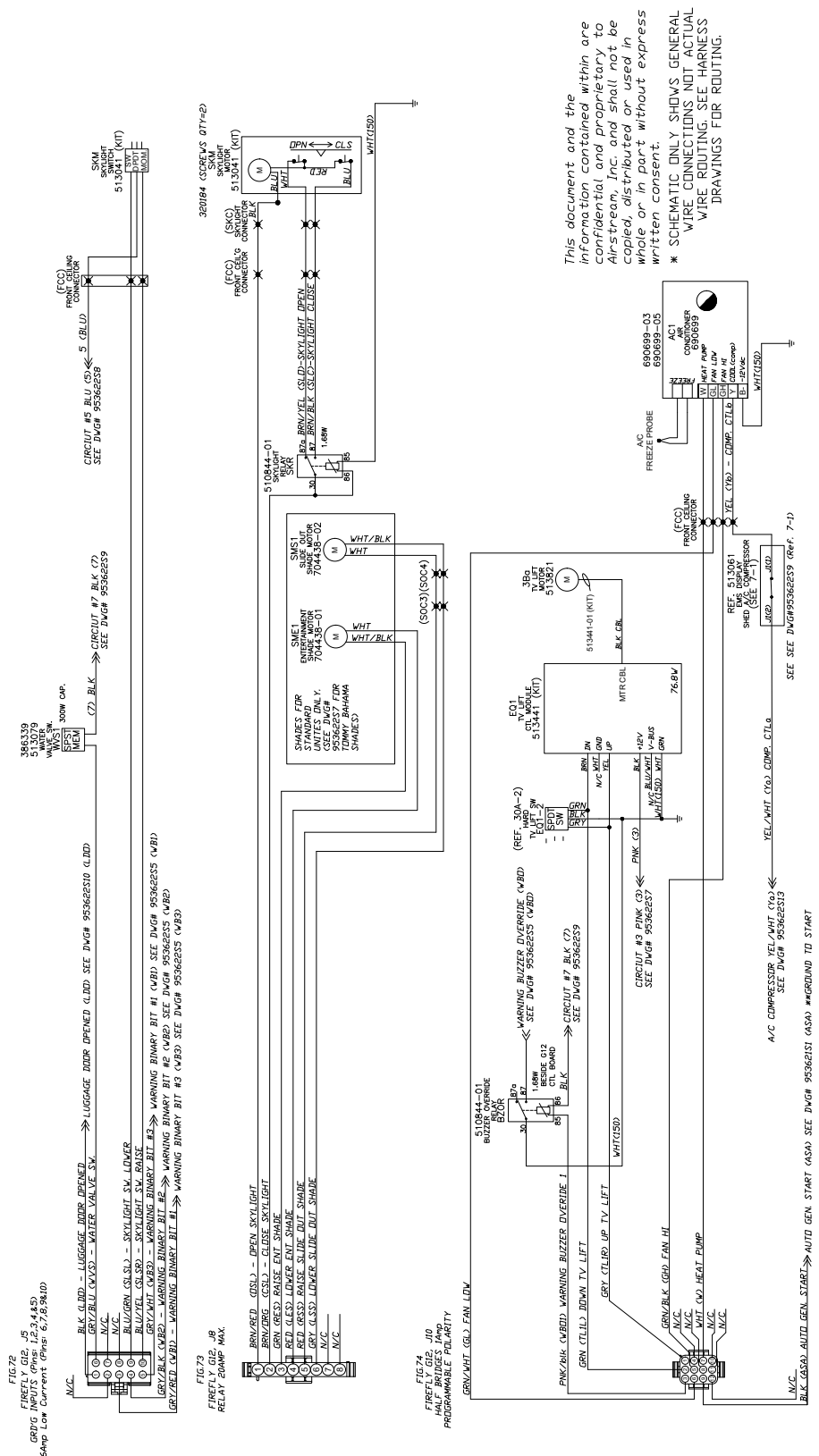

This document and the information contained within are confidential and proprietary to Airstream, Inc. and shall not be copied, distributed or used in whole or in part without express written consent.

* SCHEMATIC ONLY SHOWS GENERAL WIRE CONNECTIONS NOT ACTUAL WIRE ROUTINGS. SEE HARNESS DRAWINGS FOR ROUTING.

12-Volt Schematic

FIG.75
FIREFLY G12, J11

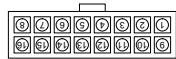

FIG.76
FIREFLY G12, J12
THERMISTORS

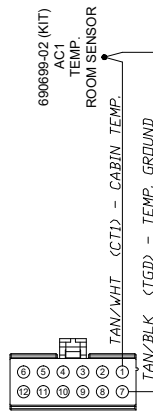
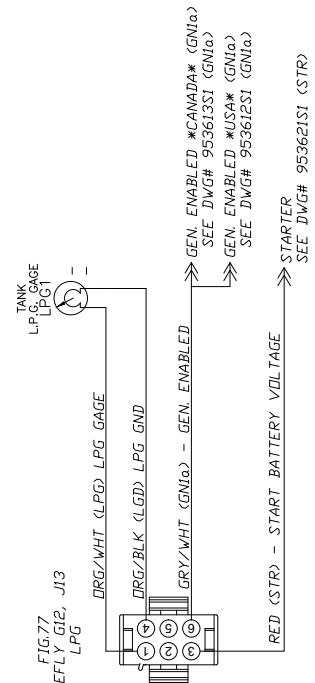

FIG.77
FIREFLY G12, J13
LPG



This document and the information contained within are confidential and proprietary to Airstream, Inc. and shall not be copied, distributed or used in whole or in part without express written consent.

* SCHEMATIC ONLY SHOWS GENERAL WIRE CONNECTIONS NOT ACTUAL WIRE ROUTING. SEE HARNESS DRAWINGS FOR ROUTING.

30-Amp 120-Volt Schematic - USA

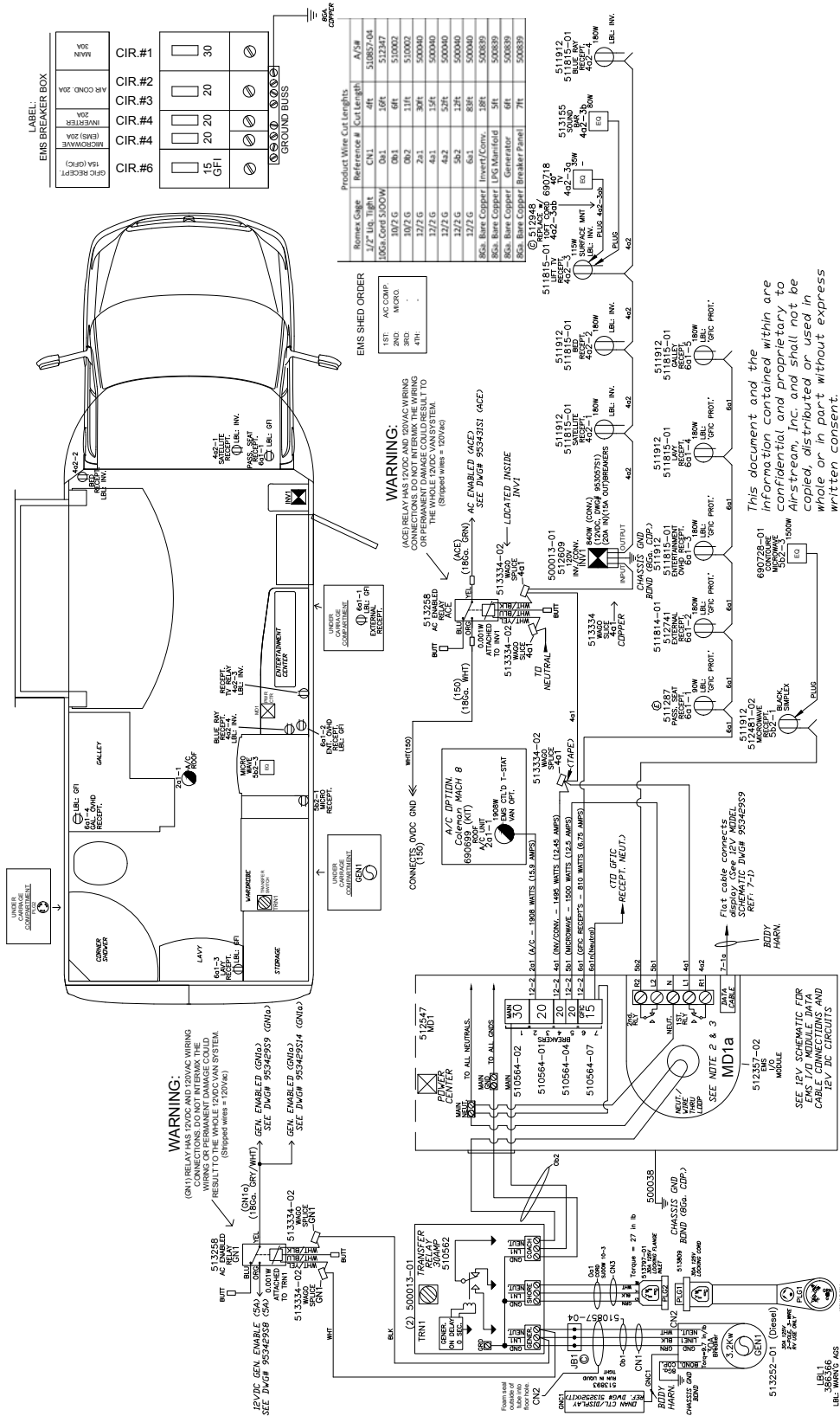

Product	Reference #	Cut Length	A/P/N
1/2" DIA. TPR	CNV	4ft.	51057-04
1/2" DIA. TPR	CRV	5ft.	51057-05
10/32" DIA. WHT	11A	10ft.	51002-10
10/32" DIA. WHT	11B	6ft.	51002-06
10/32" DIA. WHT	11C	4ft.	51002-04
10/32" DIA. WHT	11D	3ft.	51002-03
10/32" DIA. WHT	11E	2ft.	51002-02
10/32" DIA. WHT	11F	1ft.	51002-01
10/32" DIA. WHT	11G	4.5ft.	50000-04
10/32" DIA. WHT	11H	4.2ft.	50000-02
10/32" DIA. WHT	11I	3.9ft.	50000-01
10/32" DIA. WHT	11J	2.9ft.	50000-01
10/32" DIA. WHT	11K	2.6ft.	50000-01
10/32" DIA. WHT	11L	2.3ft.	50000-01
10/32" DIA. WHT	11M	2.0ft.	50000-01
10/32" DIA. WHT	11N	1.7ft.	50000-01
10/32" DIA. WHT	11O	1.4ft.	50000-01
10/32" DIA. WHT	11P	1.1ft.	50000-01
10/32" DIA. WHT	11Q	0.8ft.	50000-01
10/32" DIA. WHT	11R	0.5ft.	50000-01
10/32" DIA. WHT	11S	0.2ft.	50000-01
10/32" DIA. WHT	11T	0.1ft.	50000-01

Audio/Video Schematic

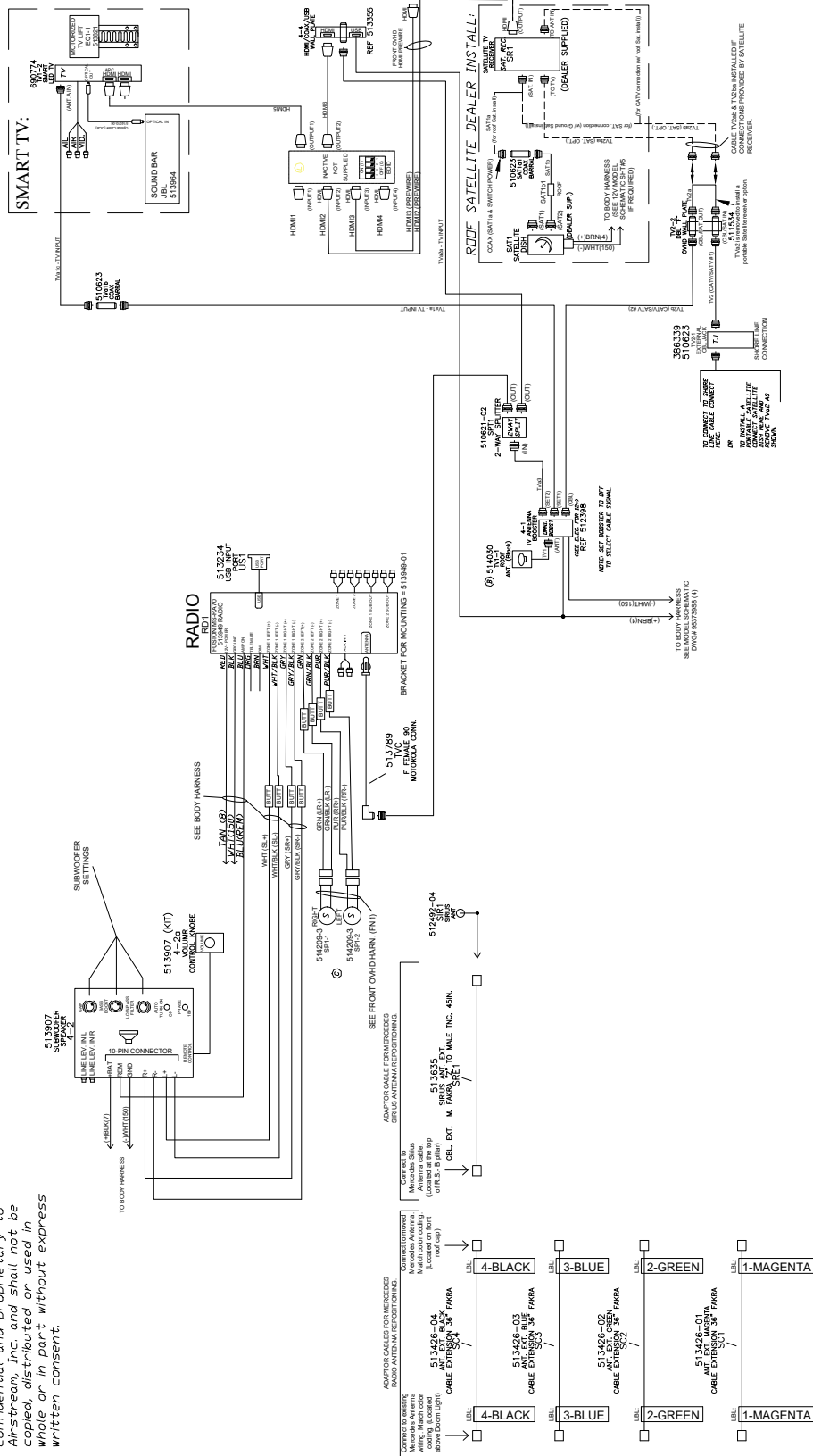

This document and the information contained within are confidential and proprietary to Airstream, Inc. and shall not be copied, distributed or used in whole or in part without express written consent.

Standard 30-Amp Circuit Breaker Layout

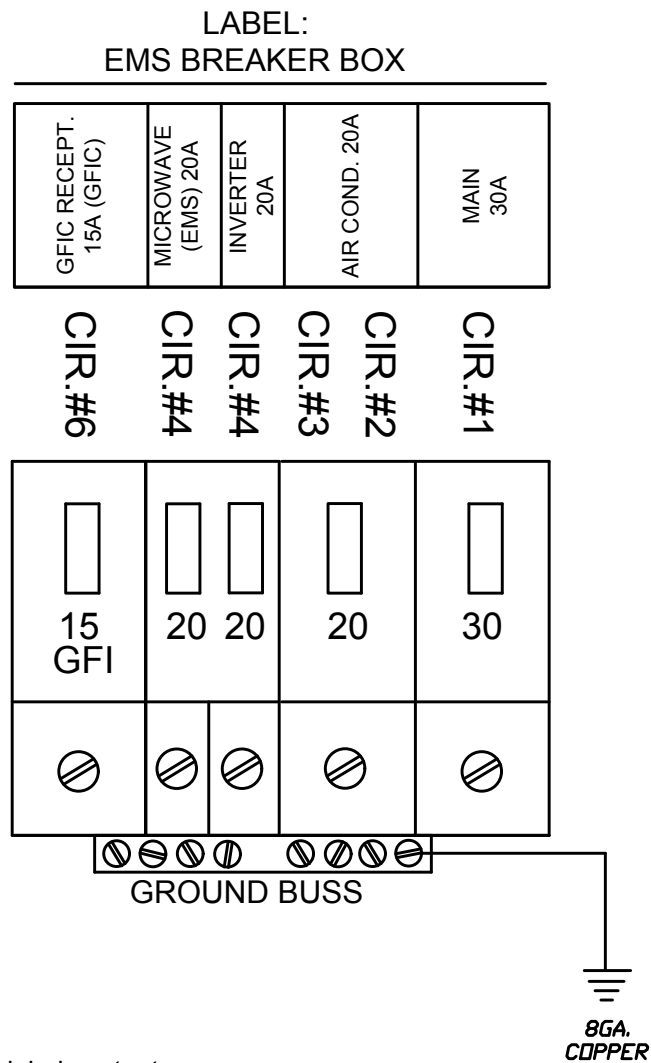

Breaker label content may vary.

Maintenance

Solar Panel Wiring

A manual on the use of the solar system is included with the Airstream Owner's Packet. Please read and understand all information before operating the system. The display panel is mounted in the upper portion of the cabinet at the entry door.

The charge controller senses the actual battery charge and regulates the charging to prevent over charging. The system requires the 12-volt feed from the battery to operate.

The following diagrams depict the way Airstream wires the solar systems and is the recommended wiring for replacement solar systems.

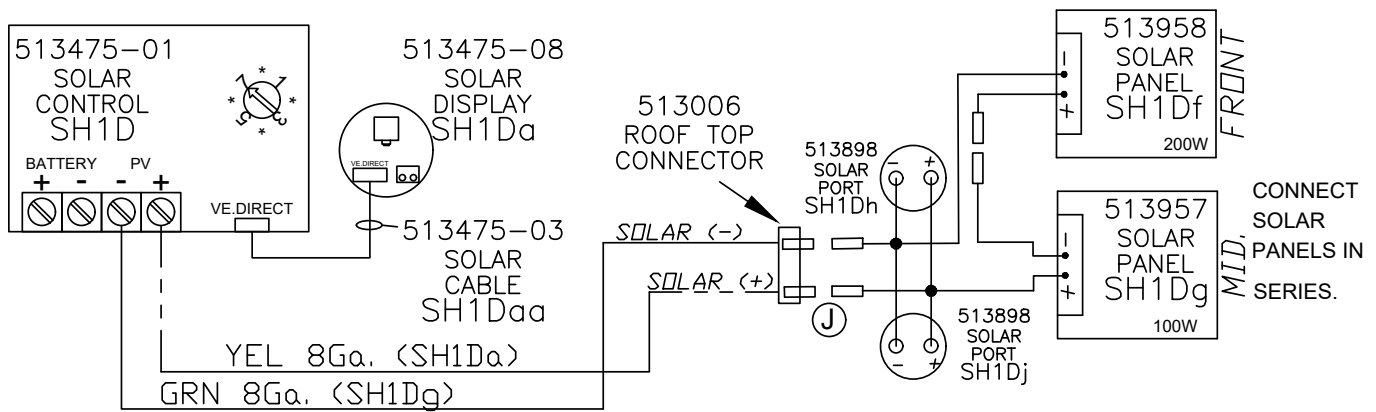

Multiplex Controls

Multiplex Circuit Control Board Layout

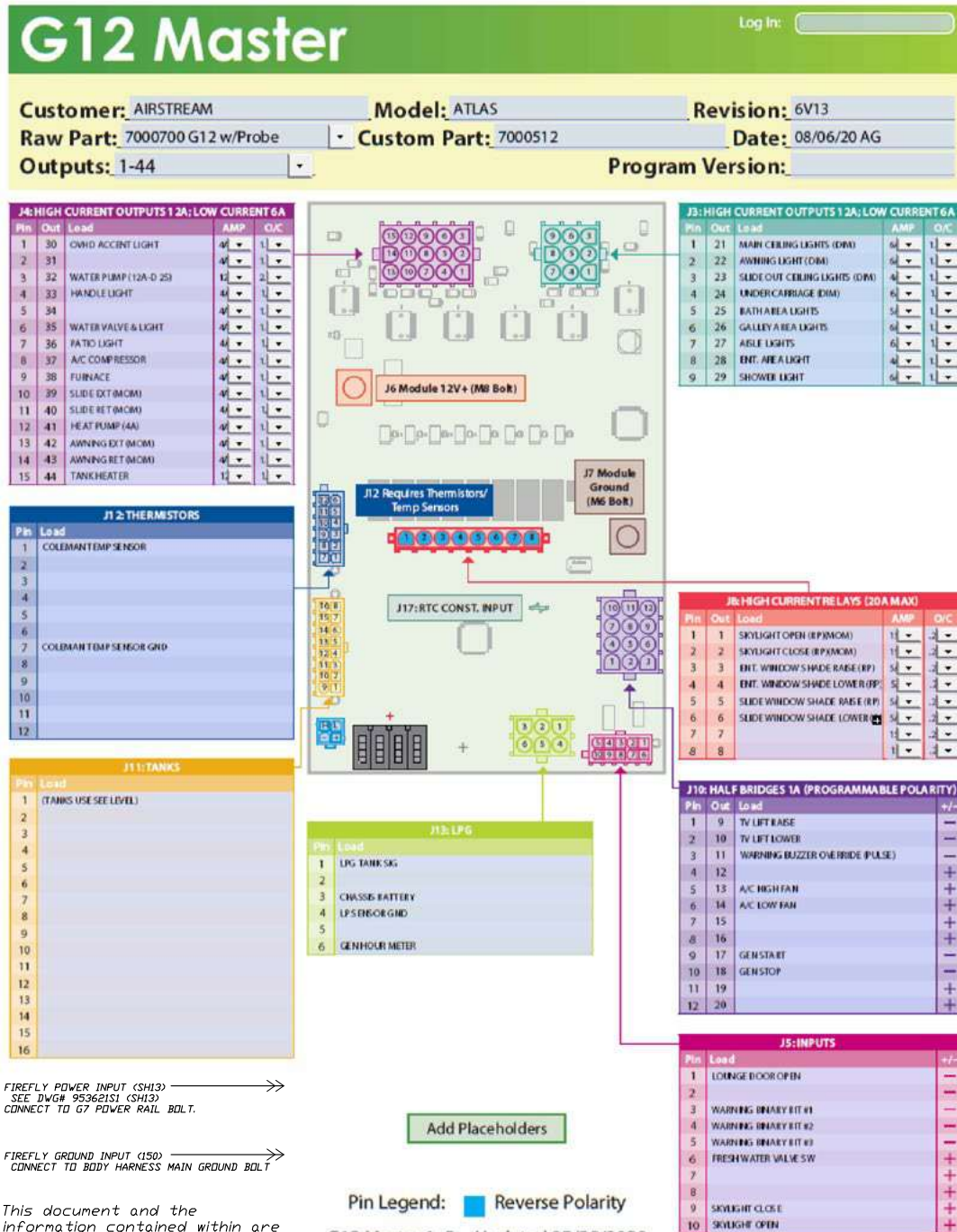

This document and the information contained within are confidential and proprietary to Airstream, Inc. and shall not be copied, distributed or used in whole or in part without express written consent from Airstream, Inc.

Multiplex Networking Diagram and Switch Panel Layout

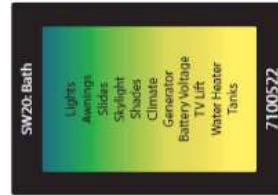
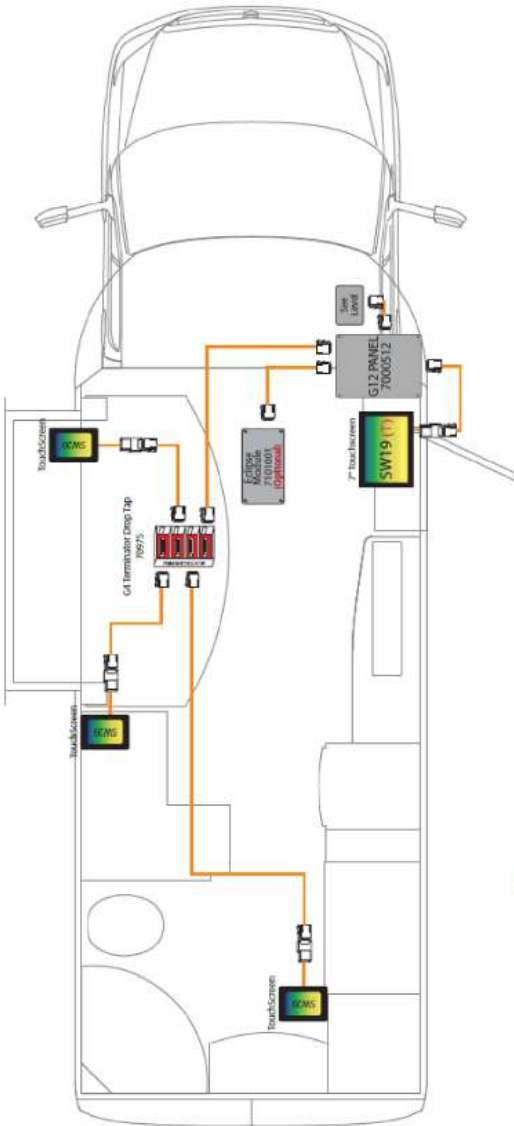

* SCHEMATIC ONLY SHOWS GENERAL WIRE CONNECTIONS NOT ACTUAL WIRE ROUTING. SEE HARNESS DRAWINGS FOR ROUTING.

This document and the information contained within are confidential and proprietary to Airstream, Inc. and shall not be copied, distributed or used in whole or in part without express written consent.

AIRSTREAM - Atlas Tommy V6 Kit: #7100070AE	
Network Wiring Diagram and Switch Panel Layout	
DL: MD/MH/AM	Pt: NP
Lyra Non-RF, Lynx	REV 6V5 09/21/2021
Network Legend	
Trunk Cable	
Drop Cable	
Switch Position	

Fresh Water Layout

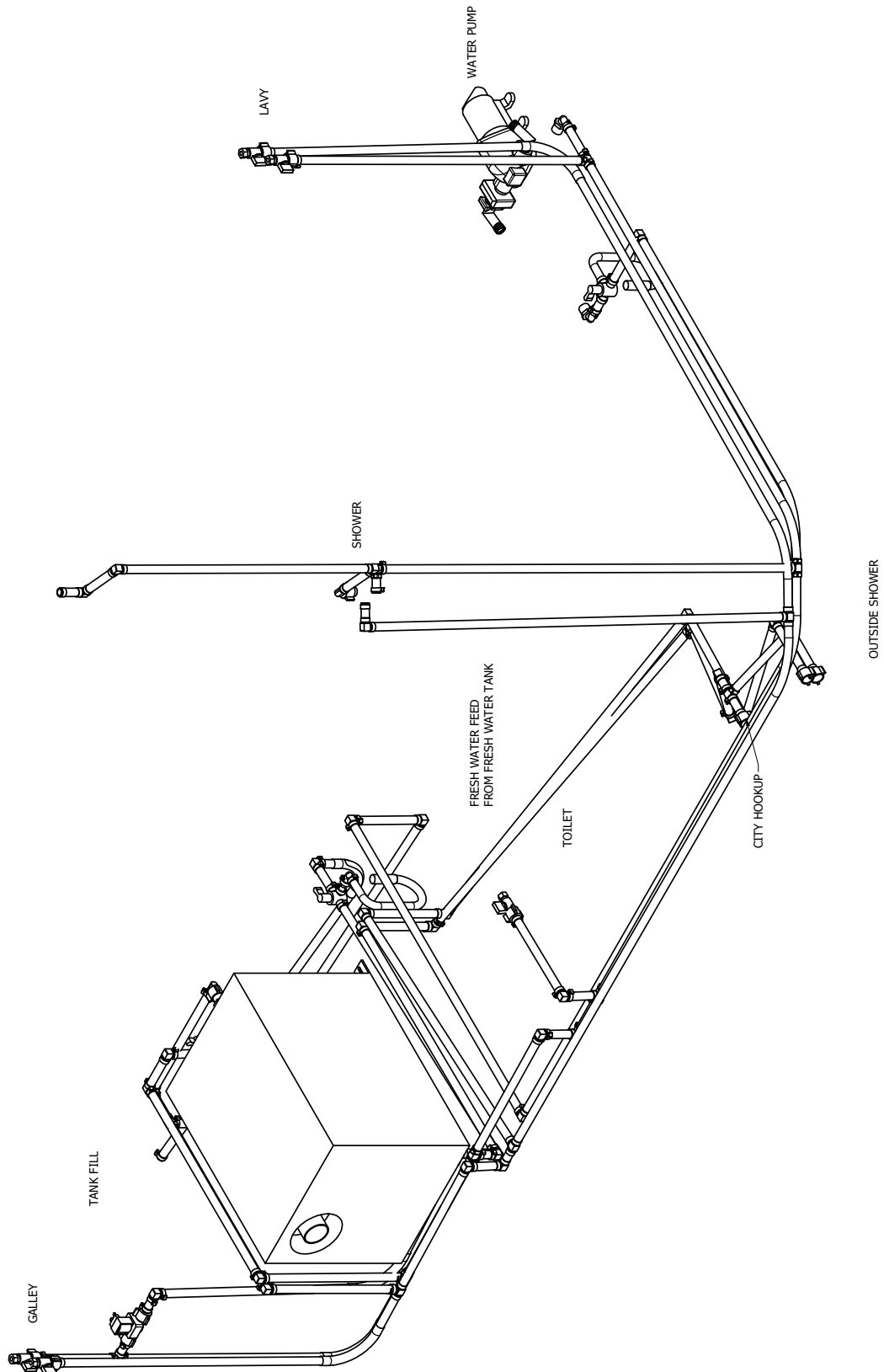

FAQs and Answers

Electrical

1. *What should I do to maintain my generator?*

Answer: During the initial break in period, you will need to check your oil every 4 hours during the first 20 hours of operation. Once you reach 20 hours of operation, you will need to change the oil. (Refer to the Onans Owner's manual for more information)

2. *My generator stalls out or quits running if I turn a corner.*

Answer: Make sure you check the oil level. There is a sensor built into the generator that will shut the engine down if it is too low. Turning the corner or stopping quickly while oil is low can cause this to happen.

3. *What size batteries are in my Airstream Atlas?*

Answer: Your Airstream is factory equipped with two BattleBorn 100Ah 12V LiFePO4 batteries.

4. *My generator will not run properly while I am showing I have fuel in the tank.*

Answer: The generators cut off is roughly 5 gallons. Although it may have a few gallons of fuel left in the tank the generator will not operate with less than 5 gallons. Try adding more fuel and restart the generator.

5. *What is the battery disconnect switch function?*

Answer: The switch is used to eliminate amp draw when the Atlas is not being used or put into storage to preserve battery charge.

6. *Do you recommend using a surge protector when plugged into shore power?*

Answer: Your Airstream is breaker protected. However, with the use of more personal electronic devices and the number of motorhome users in parks, added protection is always a plus.

7. *What is my 1000-watt Magnum inverter powering?*

Answer: It is powering the TV and any additional labeled 120-volt receptacles. This plug is designed for no more than 1000 watts combined power, and is intended for charging things such as laptops, phones, and TV usage. Plugging in items such as vacuums, hair dryers, etc. may harm the system.

8. *I have an alarm going off at my door.*

Answer: Make sure your step and awnings are completely closed. If either of these are not properly closed, and the engine is running, it will cause the alarm to sound.

Plumbing

1. *Do I need a water regulator?*

Answer: No, your Airstream is equipped with a built in regulator rated for 50 psi.

2. *How do I get fresh water into my Atlas?*

Answer: You can use the on board fresh water tank and 12-volt pump for your water supply when camping in a remote area, or hook to an external water source via potable water hose to exterior water inlet when parked at a campground.

3. *What is the difference between a Gray Water tank and the Black Water tank?*

Answer: The Gray Water tank holds water from shower and sink drains. The Black Water tank holds sewer water from the toilet.

4. *Can I run the macerator pump if there is no water going through it?*

Answer: No, it will burn the macerator up if it is run dry for more the 10-30 seconds. Also, you should not run it more than 15 minutes continuously.

5. *How do I use my Black Water tank flush?*

Answer: First, empty your Black Water tank, and then close your Black Water tank valve. Hook up your hose to the external hookup, run water through for a couple minutes, and then open the valve. Turn macerator pump on to empty the tank. Do this a couple times until the tank is clear. (Do not run macerator pump if tank is empty.)

6. *My Gray Water valve will not open while I have the Black Water valve open.*

Answer: True, you can only have one valve open at a time.

Audio-Video

1. *My TV reception is poor. What can I check?*

Answer: Verify if your antenna booster is set to proper selection (On- for antenna and Off- for cable satellite). You should also make sure connections are tight on your TV.

2. *Will my TV and DVD player (user provided) operate while traveling down the highway?*

Answer: Yes, if you have your inverter turned on, the TV will operate.

3. *Does the TV play through the dash stereo?*

Answer: No, the TV's audio is not connected to the dash radio.

Chassis

1. *Where is my spare tire located?*

Answer: The Atlas is not equipped with a spare tire or carrier. However, Coach-Net 24/7 roadside assistance has been provided to you for the first two years under the warranty. Owner's will need to re-enroll after the initial two year warranty has expired.

2. *How do I jack the Atlas up to change a tire?*

Answer: Please refer to the Mercedes owner's manual.

3. *Where can I find my Atlas' serial number?*

Answer: A label is attached on the driver's side B-pillar or the passenger's door. This label will also provide the inflation pressure of the tires and weight specifications.

Appliances

1. *I am planning for a trip in my Airstream. How should I get the refrigerator cooled down?*

Answer: Turn the power on and set the thermostat between 3 and 4. You can make further adjustments to suit your personal requirements after the box has cooled down. Allow the refrigerator to come down to temperature before loading with product. Setting the thermostat to a higher setting, e.g. 7, will not decrease the time required for the unit to cool down to its normal operating temperature. AC/DC units cool at the same rate on DC as on AC. Normal refrigerator operating temperatures are 34°F to 40°F.

2. *My air conditioner freezes up. What is the problem?*

Answer: In high humidity conditions, the manufacturer recommends you operate your AC on the high fan setting and all vents should be open to have maximum air flow over the coils; this helps reduce icing. Also, dirty AC filters can restrict air flow and cause the AC to ice up.

Maintenance

1. *Can I have my awning out with heavy winds?*

Answer: No, this may cause damage if it is too windy. However, the awning does have a built in sensor that should automatically retract the awning.

2. *I want to clean the exterior of my Airstream. What do you suggest?*

Answer: Airstream recommends washing the Atlas using a mild, auto detergent, safe for clear coated surfaces. Airstream recommends washing based on operating conditions, and waxing a minimum of twice a year. Any automotive wax designed specifically for clear coated surfaces will provides good wax protection.

AIRSTREAM®

Index

A

Air Conditioner 5-20
Air Ride Suspension 7-9
Alarms and Detectors 2-3
Antennas
 Satellite Antenna 5-19
 TV Antenna 5-18
Appliances 2-2, 5-19
Automatic Generator Start (AGS) 5-13
Awning 6-10

B

Backing Up 8-8
Battery Converter 5-15
Battery Disconnect Switch 5-15
Bed 5-6
Black Water Tank Flush 9-14
Brake Controller 8-7

C

Camping 3-7
Chemical Sensitivity 2-2
City Water Hookup 6-6
Cleaning
 Exterior 6-2
 Interior 5-3
Clothesline 5-4
Converter 5-16
Cordset 6-8

D

Detectors 2-3
Door
 Lubrication and Adjustment 9-17
Doors 6-8
Drain and Waste System 9-12
Drain System 3-10

E

Effects of Prolonged Occupancy 3-9
Electrical 5-9

Electrical Diagrams 9-18
Energy Management System (EMS) 5-12
 Display Panel 5-13
Entertainment Systems 5-18
Exterior Shower 6-7

F

Fan 5-20
FAQs and Answers 9-38
Faucets 5-5
Floor 5-4
Floor Plans 4-2
Formaldehyde 2-3
Fresh Water Layout 9-37
Furnace 5-21

G

Generator 5-22

H

Heated Tanks 3-11
Heat Pump 5-20
Hitch 8-4

I

Inverter/Charger 5-15

J

Jack 7-6

L

Loading 8-2
LPG
 Detector 2-6
 LPG Safety Information 2-7
LPG System 9-8
Regulator 9-9
Remote Fill 9-8

Index

M

Macerator Pump 9-12
 Winterizing 9-16
Maintenance Schedule 9-2
Microwave Ovens 5-22
Molds 3-10
Monitor Panel 5-11
Multiplex System 5-10
Murphy Bed 5-6

O

Overnight Stop 3-7

P

Plumbing 9-10
Power Center 5-11
Power Shades 5-8

R

Receptacles 5-16
Refrigerator/Freezer 5-22

S

Safety 2-2, 8-4
Sanitizing 9-11
Screen Door 6-8
Seat belts 8-4
Service 3-6
Shades 5-8
Shoreline Power Inlet and Cordset 6-8
Shower 6-6
Shower Stall 5-4
Slide-Out Room 5-7
SmartPlug
 Cordset 6-8
 Inlet 6-8
Sofa 5-6
Solar System 5-22
Specifications 4-3
Stabilizing Jacks 6-7
Step 6-7
Sun Shades 5-4

T

Tables 5-8
Tank heaters 3-11
Tires 7-4
 Care 9-5
 Changing 7-5
 Rotation 7-8
Toilet 5-5
 Winterizing 9-16
Towing 8-4
 Trailer 8-4
 Your Touring Coach 8-9
TV Operation 5-18

U

Utility Compartment Doors 6-9

V

Vent Fan 5-20
Ventilation 2-2, 2-3
Vinyl Floor 5-4

W

Warranty 3-2
Waste Water System 3-10
Water Heater 5-23
 Control Center 5-23
 Winterizing 9-16
Water Pump and Strainer 9-10
Water System 9-10
Weight Distribution 8-3
Winterizing and Storage 9-14
Winter Traveling 3-11

“Wherever you camp, wherever you stay, leave it cleaner than when you arrived. Not just as clean, but cleaner.” – Wally Byam

At Airstream, we take environmental awareness seriously, and we’ve made it our mission to Leave it Beautiful. That phrase is not just a marketing campaign – it’s a reminder that together we can make a difference. Leave it Beautiful is a call to action to pick up the litter, toss it in a can, and not simply step over it and pass it by. Your purchase of a new Airstream will open doors to new experiences and places you’ve only dreamed of – but it takes all of us working together to ensure those places remain pristine, accessible, and ready for the next adventure.

JOIN AIRSTREAM IN A COMMUNITY EFFORT TO

The logo for "Leave it Beautiful" features the words "leave it beautiful" written in a black, cursive script. A small blue star is positioned above the word "it". A trademark symbol (TM) is located to the right of the word "beautiful".

brought to you by  **AIRSTREAM**

AIRSTREAM[®]

428 West Pike Street

P.O. Box 629

Jackson Center, OH. 45334-0629

Phone: (937) 596-6111 Fax: (937) 596-7939

www.airstream.com