

AIRSTREAM®



SCAN ME
Live Riveted®

2025 POTTERY BARN SPECIAL EDITION

P O T T E R Y B A R N

• SPECIAL EDITION •

Owner's Manual

User Guide Videos and Airstream Academy

Scan the QR code on the cover or visit <https://support.airstream.com> to view model-specific User Guide Videos that explore topics discussed in this manual. Visit Airstream Academy at <https://www.airstream.com/academy/> to learn the ins and outs of Airstreaming by exploring videos, articles, and frequently asked questions covering a wide range of popular RV topics.

Disclaimer And Copyright

This manual, all vehicle software, and all software and content incorporated into the Smart RV or Connected RV applications and other services are subject to copyright, trademark, and other intellectual property rights of Airstream and its licensors. Do not copy, reproduce, or modify these materials without the express written permission of Airstream.

Information about Open Source software Airstream uses in connection with the Smart RV or Connect RV applications and services may be found in the Smart RV and Connected RV Terms of Service at www.airstream.com/legal-notice.

AIRSTREAM®, the Airstream trade dress, and all related model names, logos, slogans, and marks are trademarks of Thor Tech, Inc. All other trademarks contained in these materials are the property of their respective owners.

Use of third party trademarks herein does not imply sponsorship or endorsement of, or affiliation with, their respective products and services. The unauthorized use of any trademark displayed in this manual, on any Airstream vehicle, or in connection with the Smart RV or Connected RV services is strictly prohibited.

All information, illustrations and specifications contained in this manual are based on the latest product information available at the time of publication approval. If and when new materials and production techniques are developed that can improve the quality of its product, or material substitutions are necessary due to availability, Airstream reserves the right to make such changes.

Airstream Pottery Barn® Special Edition Owner's Manual

©2024 Airstream, Inc. All rights reserved

Publication Date: July 2024

REV# 01

AIRSTREAM®

TABLE OF CONTENTS

INTRODUCTION	1-1	TOWING	7-1
SAFETY	2-1	Tow Vehicle	7-2
Safety Precautions	2-2	Brakes	7-2
Chemical Sensitivity and Ventilation	2-2	Loading	7-3
Alarms and Detectors	2-3	Hitching Up	7-4
GENERAL INFORMATION	3-1	Towing	7-5
Limited Warranty Policy	3-2	MAINTENANCE	8-1
Service	3-6	Maintenance Schedule	8-2
Camping	3-7	Suggested Maintenance and Replacement Parts	8-3
FLOOR PLANS AND SPECIFICATIONS	4-1	Tires	8-5
Floor Plans	4-2	Axles and Brakes	8-10
Specifications	4-3	Power Jack	8-11
INTERIOR	5-1	Batteries	8-12
General Information and Cleaning	5-3	Water Pump	8-14
Plumbing	5-5	Black and Gray Water Tank Draining	8-15
Electrical	5-7	Winterizing and Storage	8-16
Entertainment Systems	5-14	Main Door Care	8-18
Smart RV Control Technology	5-16	Windows	8-18
Appliances	5-18	Electrical Diagrams	8-19
EXTERIOR	6-1	Multiplex Controls	8-23
Cleaning	6-2	Fresh Water Layout	8-27
General Information and Operation	6-3	FAQs and Answers	8-28

AIRSTREAM®

Section 1 INTRODUCTION

The Owner's Manual for your new Airstream trailer is designed to respond to the most frequent inquiries regarding the operation, function, and care of the many systems that make modern trailering a joy.

Airstream realizes our customers possess varying degrees of expertise in the area of maintaining and repairing the appliances in their trailer. For this reason, the service information found in this manual is directed toward those with average mechanical skills.

We also realize that you may be more familiar with one area than you are with another. Only you know your capabilities and limitations. We want you to use this manual and hope you will find the information contained in it useful. However, should you ever feel that you may be in need of assistance, please consult your Airstream dealer for advice on service that may be required.

A brief explanation of the operation of the appliances such as refrigerator, furnace, water heater, and others, are explained in this manual. However, you will also find the manufacturer's information, supplied in a packet included with this manual, to be more detailed.

All information, illustrations, and specifications contained in this manual are based on the latest product information available at the time of publication approval. If and when new materials and production techniques are developed that can improve the quality of its product, or material substitutions are necessary due to availability, Airstream reserves the right to make such changes.

Optional items may be available on all, or particular models. Additionally, some optional items can only be included during the manufacturing phase and cannot later be added to the trailer.

The inclusion of optional items information in this manual does not imply or suggest the availability, application, suitability, or inclusion for any specific unit.

Airstream uses the  safety alert symbol and signal words Danger, Warning, and Caution to alert you to potential personal injury hazards. Obey all safety messages that follow this symbol to avoid possible injury or death. The following are examples of each type of signal word, safety message, and information message found throughout this manual.

DANGER

Indicates a hazardous situation which, if not avoided, will result in death or serious injury.

WARNING

Indicates a hazardous situation which, if not avoided, could result in death or serious injury.

CAUTION

Indicates a hazardous situation which, if not avoided, could result in minor or moderate injury.

NOTICE

Indicates a potential situation which, if not avoided, may result in damage to your Airstream. Addresses practices not related to personal injury.

NOTE

Provides noteworthy information and tips about your Airstream.

AIRSTREAM®

Section 2 SAFETY

SAFETY PRECAUTIONS	2-2	ALARMS AND DETECTORS	2-3
Transporting of Passengers	2-2	Smoke Alarm.	2-3
Towing and Weight Distribution.	2-2	Liquid Propane Gas (LPG)/Carbon	
Controlling Sway	2-2	Monoxide (CO) Detector	2-4
Lug Nut Torquing	2-2	Low Voltage	2-4
Tire Safety	2-2	Detector Test	2-4
Appliances and Equipment	2-2	This Carbon Monoxide Detector Is Not	2-5
Mold	2-2	Important Safety Precautions.	2-5
CHEMICAL SENSITIVITY AND VENTILATION	2-2	What Is Carbon Monoxide	2-5
Chemical Sensitivity	2-2	Conditions that can result in potentially	
Formaldehyde	2-3	dangerous CO situations	2-6
Ventilation	2-3	Symptoms of Carbon Monoxide Poisoning	2-6
Do Not Smoke	2-3	Basic Rules For LPG Safety	2-6
Medical Advice	2-3	If You Smell Gas.	2-7
		Fire Extinguisher	2-7
		Safety	2-7

Safety Precautions

Many things can be construed as safety related, but the most important is your common sense. If you are careless with matches, cigarettes, flammable material, or any other hazardous material, you surely realize your potential for accidents is greatly increased.

You will find many safety recommendations in this section and throughout the manual. The following recommendations are the ones we consider to be the most important.

Transporting of Passengers

The transporting of people in the trailer puts their lives at risk and may be illegal. The trailer does not have seat belts, therefore, it is not designed to carry passengers.

⚠ WARNING

Never transport passengers inside a trailer. Towing a trailer with passengers inside is unsafe and could result in death or serious injury.

Towing and Weight Distribution

Weight distribution is an important factor when loading your travel trailer. A recreational vehicle with the cargo distributed properly will result in efficient, trouble-free towing; [see Loading on page 7-3](#).

Controlling Sway

Sway or fishtailing is the sideways action of a trailer caused by external forces. Excessive sway of your travel trailer can lead to the rollover of the trailer and tow vehicle, resulting in serious injury or death; [see Controlling Sway or Fishtailing on page 7-8](#).

Lug Nut Torquing

Making sure wheel mounting nuts (lug nuts) on trailer wheels are tight and properly torqued is an important responsibility that trailer owners and users need to understand and practice. Inadequate and/or inappropriate wheel nut torque (tightness) is a major cause of lug nuts loosening in service. Loose lug nuts can rapidly lead to a wheel separation, resulting in potentially serious safety consequences; [see Lug Nut Torquing on page 8-9](#).

⚠ WARNING

Use a torque wrench to tighten lug nuts. Tightening by hand or with an impact wrench is not recommended. For lug nut torque values, [see Specifications on page 4-3](#).

Tire Safety

Properly maintained tires improve the steering, stopping, traction, and load-carrying capability of your vehicle; [see Tire Care on page 8-6](#). Also, be sure to read the Tire Safety Manual Addendum included with your owner's packet.

Appliances and Equipment

The appliances (cooktop) and equipment (hot water heater, furnace, etc.) typically operate on liquefied petroleum gas. LP gas is flammable and is contained under high pressure. Improper use may result in a fire and/or explosion. Make sure to follow all instructions and warnings in this manual as well as those in the specific owner's manuals of the appliances and equipment.

NOTE

For additional LPG warnings and safety information, [see Section 5](#) and [Section 6](#).

Mold

Mold and mold spores exist throughout indoor and outdoor environments. There is no practical way to eliminate all mold and mold spores in the indoor environment; however, the way to control indoor mold growth is to control moisture; [see Inhibiting Mold Growth on page 3-10](#).

Chemical Sensitivity and Ventilation

Chemical Sensitivity

Immediately after the purchase of your new recreational vehicle, and sometimes, after it has been closed up for an extended period of time, you may notice a strong odor and/or experience a chemical sensitivity. This is not a defect in your recreational vehicle. Like your home, there are many different products used in the construction of recreational vehicles, such as carpet, linoleum, plywood, insulation, upholstery, etc. Formaldehyde is also the by-product of combustion and numerous household products, such as some paints, coatings, and cosmetics. However, recreational vehicles are much smaller than your home and therefore, the exchange of air inside a recreational vehicle is significantly less than in a home. These products, when new or when exposed to elevated temperatures and/or humidity, may off-gas different chemicals, including formaldehyde. This off-gassing, in combination with the minimal air exchange, may cause you to experience irritation of the eyes, nose, and throat, as well as sometimes headache, nausea,

and a variety of asthma-like symptoms. Elderly persons and young children, as well as anyone with a history of asthma, allergies, or lung problems, may be more susceptible to the effects of off-gassing.

Formaldehyde

Formaldehyde is a naturally occurring substance and is an important chemical used widely by industries to manufacture building materials and numerous household products. It is also a by-product of combustion and certain other natural processes. Thus, it may be present inside the trailer with some individuals being sensitive to it. Ventilation of the unit normally reduces the exposure to a comfortable level.

Trace levels of formaldehyde are released from smoking; cooking; use of soaps and detergents, such as carpet shampoos, cosmetics; and many other household products. Some people are very sensitive to formaldehyde while others may not have any reaction to the same levels of formaldehyde. Amounts released decrease over time.

Your Airstream trailer was manufactured using low formaldehyde-emitting (LFE) wood products, use of which is typical in the recreation vehicle industry. Formaldehyde has an important role in the adhesives used to bind wood products used in recreation vehicles. The wood products in your trailer are designed to emit formaldehyde at or lower than industry guidelines and should not produce symptoms in most individuals.

While LFE wood products typically do not emit formaldehyde at a level that would cause symptoms in most individuals, it is possible, though not likely, for that to occur when the trailer is not properly ventilated. Ventilation is an essential requirement for trailer use, for many reasons. Any effects of formaldehyde can be greatly reduced by actions such as opening windows, opening roof vents, running the air conditioner, or some combination thereof. In addition, the emission of formaldehyde by these products naturally decreases rapidly over time.

Airstream strongly suggests that you take measures to properly ventilate your trailer on a regular basis. If you have any questions with respect to proper ventilation of your trailer, please do not hesitate to contact your dealer or Airstream.

Ventilation

To reduce or lessen exposure to chemicals from off-gassing, it is of utmost importance that you ventilate your recreational vehicle. Ventilation should occur

frequently after purchase and at times when the temperatures and humidity are elevated. Remember, off-gassing is accelerated by heat and humidity. Open windows, exhaust vents, and doors. Operate ceiling and/or other fans, roof air conditioners, and furnaces. Use a fan to force stale air out and bring fresh air in. Decreasing the flow of air by sealing the recreational vehicle increases the formaldehyde level in the vehicle's indoor air.

Do Not Smoke

It is recommended you do not smoke inside your recreational vehicle. In addition to causing damage to your recreational vehicle, tobacco smoke releases formaldehyde and other toxic chemicals.

Medical Advice

Questions regarding the effects of formaldehyde on your health should be submitted to your doctor or local health department.

Alarms and Detectors

Smoke Alarm

A smoke alarm is provided with your trailer. A manual pertaining to the alarm is included in the paperwork given to you at the dealership. Please read and follow all care, maintenance, and safety information contained in the smoke alarm manual.

The smoke alarm will beep once a minute for at least 30 days when the battery is weak. The battery must immediately be replaced with a fresh one.

⚠ WARNING

Alarm battery is shipped deactivated. Check your alarm for proper battery installation. To activate battery, new Airstream owner's must install included battery to proper orientation.

⚠ WARNING

Smoke alarms have a limited life. The unit should be replaced immediately if it is not operating properly. You should always replace a smoke alarm after 10 years from the date of purchase. Write the purchase date on the space provided on the back of unit.

If service is required or you have not received a smoke alarm user's manual, please contact the manufacturer, your dealer, or Airstream Customer Service.

Liquid Propane Gas (LPG)/Carbon Monoxide (CO) Detector



This detector has a five-year life; see end-of-life notification in the detectors manual. Please read the entire detector manual before operating the unit.

⚠ WARNING

Activation of your Carbon Monoxide alarm's audible horn indicates the presence of Carbon Monoxide that can kill you. Leave the area immediately!

⚠ WARNING

Failure to replace this product by the "REPLACE BY DATE" printed on the alarm may result in death by Carbon Monoxide poisoning. Replace By Date is five (5) years from the date of manufacture.

The LPG/CO detector is located in the galley area. LPG is a mixture of gases produced and sold commercially as a fuel for heating and cooking appliances. LPG is highly flammable and, as a result, can be explosive if ignited under certain circumstances. LPG is heavier than air and, if confined in a closed space, will accumulate close to the floor. The LPG/CO detector is designed to alarm when propane gas exceeds 10% of the lower-explosive-limit for more than 30 seconds or if CO gas reaches unsafe levels. When propane gas is detected the horn will sound with constant beeps and the red LED will be on. If CO gas is detected the horn will sound with 4 rapid chirps followed by a 4 second pause and the red LED will flash rapidly.

Your LPG/CO detector is wired directly to your trailer battery and incorporates a 1-amp, in-line fuse. It has no internal battery backup. In normal stand-by mode, the LED indicator will be green.

Low Voltage

The operating voltage for the detector is 12 VDC. The actual voltage supplied to the detector in a recreational vehicle may drop below the minimum 8 VDC. The

detector provides the user with a low voltage warning before reaching that level and will provide additional distinct, clear warnings and alarms after the 8 VDC level is reached. However, if available power supplied to the unit is below the operating voltage of 8 VDC, the detector will not detect gas or provide protection against dangerous levels of LPG.

⚠ WARNING

If the low voltage warning sounds, the detector will need to be reset by disconnecting the battery, before normal operation will occur.

Detector Test

If the Silence/Test button is pressed while in normal operation, the alarm will perform a self test of the CO sensor, propane sensor and battery voltage. It is recommended to perform a self test weekly, after power up from storage, and before each trip. If the self test passes, the alarm will perform 2 cycles of the CO horn pattern (4 rapid chirps followed by a 4 second pause), followed by 2 cycles of the propane horn pattern (constantly beeping).

⚠ WARNING

Activation of this detector indicates the possible presence of LPG, which can cause an explosion and/or fire, causing serious injury or death. This normally indicates a leak in the LPG installation or an LPG appliance. Extinguish all open flames, open your windows and door, and evacuate the unit immediately. Do not activate any electrical switch. Turn off the LPG at your gas tank(s). Do not re-enter your unit until a qualified repair technician has corrected the problem and certified the system as safe.

⚠ WARNING

Have a qualified technician check your LPG system annually or if you detect any signs of leaks or malfunctions.

NOTE

For additional LPG warnings and safety information see [Section 5](#) and [Section 6](#).

⚠ WARNING

Airstream recommends shutting off the gas supply at the LPG tanks before refueling the tow vehicle or entering a refueling station.

⚠ WARNING

This product is intended for use in ordinary, indoor locations of family living units. It is not designed to measure compliance with occupational safety and health administration (OSHA) commercial or industrial standards. Individuals who are at special risk from Carbon Monoxide exposure by reason of age, pregnancy, or medical condition may consider using warning devices which provide audible and visual signals for Carbon Monoxide concentration under 30 ppm. If in doubt, consult your medical practitioner.

NOTICE

It is not recommended that the detector be disconnected from the battery during periods of storage. There is a small heater on the sensor of the device that burns away impurities in the air during periods of normal use. During periods when power is interrupted, impurities can build up on the sensor. When power is returned to the detector, the detector alarm may activate until the impurities are burned off. This could take a number of hours, during which time the alarm will be constantly on.

This Carbon Monoxide Detector Is Not

- Designed to detect smoke, fire, or any gas other than Carbon Monoxide.
- To be seen as a substitute for the proper servicing of fuel-burning appliances.
- To be used on an intermittent basis, or as a portable alarm for spillage of combustion products from fuel-burning appliances.

⚠ WARNING

This Carbon Monoxide detector is designed for indoor use only. Do not expose to rain or moisture. Do not knock or drop the alarm. Do not open or tamper with the alarm as this could cause malfunction. The detector will not protect against the risk of Carbon Monoxide poisoning when the batteries are dead or missing. The alarm will only indicate the presence of CO gas at the sensor.

Important Safety Precautions

- Carbon Monoxide is produced by the incomplete combustion of fuels such as wood, charcoal, coal, heating oil, paraffin, gasoline, natural gas, propane, butane, etc.
- Ideally, it is recommended that a Carbon Monoxide detector should be installed in or near every room that has a fuel burning appliance such as any room heaters, water heaters, cookers, grills, etc.
- Ensure that the alarm horn can be heard by all those who are intended to hear it. Seek medical help if it is suspected that a user of the RV is suffering from Carbon Monoxide poisoning.
- If the alarm sounds, make sure to investigate the problem. Ignoring the alarm may result in sickness, injury or death. (CO may be present even if nothing is seen or smelled by the user.)
- Room spaces should be well ventilated when household cleaning supplies are used as these may cause a false alarm.
- Alarm should be tested once per week. If further details are required, which do not appear in this manual, contact the manufacturer.

What Is Carbon Monoxide

Carbon Monoxide (CO) is a highly poisonous gas that is released when fuels are burned. It is invisible, has no smell, and is therefore very difficult to detect with the human senses. Under normal conditions, in a room where fuel-burning appliances are well maintained and correctly ventilated, the amount of CO released into the room by appliances is not dangerous.

These fuels include wood, coal, charcoal, oil, natural gas, gasoline, kerosene, and propane. Common appliances are often sources of CO. If they are not properly maintained, are improperly ventilated, or malfunction, CO levels can rise quickly. CO is a real danger in air-tight trailers with added insulation, sealed windows, and other weatherproofing that can trap CO inside.

Conditions that can result in potentially dangerous CO situations

1. Excessive spillage or reverse-venting of fuel-burning appliances caused by outdoor conditions, such as:
 - Wind direction and/or velocity, including high gusts of wind.
 - Heavy air in the vent pipes (cold/humid air with extended periods between cycles).
 - Negative pressure differential resulting from use of exhaust fans.
 - Simultaneous operation of several fuel-burning appliances competing for limited internal air.
 - Vent-pipe connections vibrating loose from clothes dryers, furnaces, or water heaters.
 - Obstructions in or unconventional vent-pipe designs which can amplify the above situations.
2. Extended use of un-vented fuel burning devices.
3. Temperature increase that can trap exhaust gases near the ground.

Symptoms of Carbon Monoxide Poisoning

- Mild Exposure - Slight headache, nausea, vomiting, fatigue (flu-like symptoms).
- Medium Exposure - Throbbing headache, drowsiness, confusion, fast heart rate.
- Extreme Exposure - Convulsions, unconsciousness, heart and lung failure. Exposure to carbon monoxide can cause brain damage and/or death.

⚠ DANGER

Many causes of reported CARBON MONOXIDE POISONING indicate that while victims are aware that they are not well, they become so disoriented that they are unable to save themselves by either exiting the area or calling for assistance. Also young children and pets may be the first to be affected.

⚠ WARNING

Test units used in RVs after the vehicle has been in storage, before each trip, and once a week while in use. Failure to test units used in RV's as described may remove your protection.

Basic Rules For LPG Safety

A warning label is displayed in the cooking area reminding you to provide an adequate supply of fresh air for combustion. The amount of oxygen supply in a trailer is limited due to its compact design. When using the cooking appliances, proper ventilation will prevent dangers of asphyxiation. It is especially important that cooking appliances not be used for comfort heating as the danger of asphyxiation is greater when the appliance is used for long periods of time.

⚠ DANGER

Do not use cooking appliances for comfort heating. Cooking appliances need fresh air for safe operation. Before operation, open an overhead vent or turn on an exhaust fan and open a window.

⚠ DANGER

A warning label has been located near the LPG container. This label reads: DO NOT FILL CONTAINER(S) TO MORE THAN 80 PERCENT OF CAPACITY. Overfilling the LPG container can result in uncontrolled gas flow, which can cause fire or explosion. A properly filled container will contain approximately 80 percent of its volume as liquid LP gas.

⚠ DANGER

Do not store LPG tanks within a vehicle. LPG tanks are equipped with safety devices that vent gas should the pressure become excessive.

⚠ DANGER

Portable fuel burning equipment, including wood and charcoal grills and stoves, shall not be used inside the recreational vehicle. The use of this equipment inside the recreational vehicle may cause fires or asphyxiation.

⚠ DANGER

Do not bring or store LPG tanks, gasoline, or other flammable liquids inside the vehicle because a fire or explosion may result.

Twice a year, or after a long storage period, we suggest you take your unit in for a checkup and cleaning of the gas-operated appliances.

If You Smell Gas

1. Extinguish any open flames, pilot lights, and all smoking materials.
2. Do not touch electrical switches.
3. Shut off the gas supply at the tank valve(s) or gas supply connection.
4. Open doors and other ventilating openings.
5. Leave the area until odor clears.
6. Have the gas system checked and leakage source corrected before using again.

Fire Extinguisher

The fire extinguisher should be checked for charge on a regular basis. Make sure your family knows how to release the extinguisher storage bracket and how to properly operate the extinguisher. Check with your local fire department for professional advice on its operation and use if you find the directions on the extinguisher unclear. They will be able and willing to assist you and your family.

Safety

As always, safety should be a top priority. Ensure you and everyone traveling with you can operate the main door and emergency exit window rapidly, without light. Contemplate other means of escape in case the designated exits are blocked.

The escape window(s) are identified by their red release handles. Lift up on both latches to release the escape window. Push on the glass and it will swing clear.

⚠ WARNING

The window operation should be checked before each trip and the latches lubricated with silicon spray or an equivalent lubricant every 3 months.

⚠ WARNING

Read the directions on the fire extinguisher carefully. If you have any doubts as to its operation, you and your family should practice, and then replace or recharge the extinguisher. Your local fire department will be able to assist you and answer any questions.

AIRSTREAM®

Section 3 GENERAL INFORMATION

LIMITED WARRANTY POLICY	3-2	CAMPING	3-7
This Limited Warranty Covers	3-2	Suggested Pre-Travel Check List	3-7
Coverage Ends	3-2	Interior	3-7
Limitation Of Implied Warranties	3-2	Exterior	3-7
Disclaimer Of Incidental And Consequential Damages	3-2	Trailer Equipment and Accessories	3-7
Repair Remedy	3-2	Motoring Essentials	3-7
Back-Up Remedy	3-2	Overnight Stop	3-8
What Is Not Covered	3-3	Extended Stay	3-8
Obtaining Warranty Service	3-4	Leveling	3-8
Events That Discharge Airstream's Obligations Under This Limited Warranty	3-4	Stabilizing Jacks	3-9
Legal Remedies	3-4	Effects Of Prolonged Occupancy	3-9
Airstream Limited Warranty Excludes	3-5	Tips To Control Condensation	3-9
Normal Wear	3-5	Molds	3-10
Accident	3-5	Contributing Factors To Mold Growth	3-10
Abuse	3-5	Inhibiting Mold Growth	3-10
Chemical Gassing	3-5	Waste Water System	3-10
Exposure	3-5	Things Not To Put Into Toilet Or Drains	3-11
Overload	3-5	Winter Traveling	3-11
SERVICE	3-6		
Coach-Net® Roadside Assistance	3-6		
Service Centers	3-6		
Reporting Safety Defects	3-6		

Limited Warranty Policy

This Limited Warranty Covers

(i) The first retail owner and any subsequent owners
(ii) ONLY those portions of a NEW travel trailer not excluded under the section “What is Not Covered,” when sold by an authorized dealership and used for its intended purpose of recreational travel and camping; and, (iii) ONLY defects in workmanship performed and/or materials used to assemble those portions of your travel trailer not excluded under the section “What is Not Covered.” “Defect” means the failure of the workmanship performed and/or materials used to conform with the design and manufacturing specification and tolerances of Airstream. This Limited Warranty is transferable, and the subsequent owner’s warranty coverage period shall be the unexpired balance of the original warranty coverage period. A completed copy of the Warranty Transfer Form must be submitted to Airstream at the time of resale.

When you request and accept the performance of warranty repairs under the terms of this Limited Warranty, you are accepting all terms of this Limited Warranty, including by way of example, warranty limitations and disclaimers, the forum selection clause and the clause reducing the time period when suit must be filed for breach.

If any term or condition in this limited warranty conflicts with your state’s Uniform Commercial Code (“UCC”) as interpreted by courts within your state, the provisions of your state’s UCC are varied as allowed for by USS 1-302.

Coverage Ends

36 months after the first retail owner first takes delivery of the travel trailer from an authorized dealership. Any action for breach of this warranty or any implied warranties must be commenced not more than 37 months after you first take delivery. Some states do not allow the reduction of the time when a breach of warranty claim must be commenced, so the reduction in time when a breach of warranty claim must be commenced may not apply to you.

Limitation Of Implied Warranties

Implied warranties arising under applicable law, if any, including but not limited to implied warranties of merchantability or fitness for a particular purpose, are hereby limited in duration to the term of this limited warranty and are limited in scope of coverage to those portions of the travel trailer covered by this limited warranty. There are no express warranties or any

implied warranties of merchantability on those portions of the travel trailer excluded from coverage. There is no warranty of any nature made by Airstream beyond that contained in this limited warranty. No person has authority to enlarge, amend, or modify this limited warranty. The dealer is not Airstream’s agent. Airstream is not responsible for any undertaking, representation, or warranty made by any dealer or others beyond those expressly set forth within this limited warranty. Some states do not allow limitations on how long an implied warranty lasts, so the above limitations may not apply to you.

Disclaimer Of Incidental And Consequential Damages

Airstream disclaims any and all incidental and consequential damages, including but not limited to expenses such as transportation to and from dealerships and Airstream repair facilities, loss of time, loss of pay, loss of use, inconvenience, commercial loss (including but not limited to lost profits), towing charges, bus fares, vehicle rental, service call charges, gasoline expenses, incidental charges such as telephone calls and facsimile transmissions, and expenses for lodging and moisture damage such as mold and mildew as well as rust and corrosion. This disclaimer is independent of any failure of the essential purpose of any warranties provided with the travel trailer and shall survive any determination that a warranty failed of its essential purpose. Some states do not allow the exclusion or limitation of incidental or consequential damages, so the above limitation or exclusion may not apply to you.

Repair Remedy

Airstream’s sole and exclusive obligation is to repair any covered defects discovered within the warranty coverage period if: (1) within 10 days of your discovery of a defect, you notify Airstream OR an authorized dealership of the defect; AND (2) you deliver your travel trailer to Airstream OR an authorized dealership at your cost and expense.

Back-Up Remedy

If the primary repair remedy fails to successfully cure any defect after a reasonable number of repair attempts, your sole and exclusive remedy shall be to have Airstream pay an independent service shop of your choice to perform repairs to the defect, which requires the exercise of good faith. If you select an independent service shop, you must notify Airstream to allow it to work directly with the service shop to have repairs performed. The repair remedy and the back-up

remedy MUST both be exhausted AND these remedies must fail to fulfill their essential purpose before you can seek other legal or equitable remedies for breach of this express warranty or for breach of any implied warranty. This limited warranty is not a warranty that promises or extends to future performance because the warranty does not make a representation on how your travel trailer will perform in the future but instead represents only what the remedy will be if a defect exists.

Unless prohibited by state law, repairs will not extend the time when you must commence a breach of warranty claim and shall not extend the warranty coverage period. Any performance of repairs after the warranty coverage ends OR any performance of repairs to those portions of your travel trailer excluded from coverage shall be considered “good will” repairs. Warranty repairs should be expected. Airstream may use new and/or remanufactured parts and/or components of substantially equal quality to complete a repair. Damage to interior or exterior surfaces, trim, upholstery, and other appearance items may occur at the factory during assembly, during delivery of the travel trailer to your selling dealer or on the selling dealer’s lot. Normally, any damage is detected and corrected at the factory or by the selling dealer during the inspection process. If you discover any damage when you take delivery of your travel trailer, you MUST notify your dealer OR Airstream within 10 days of the date of purchase to have damage repaired at no cost to you. Minor adjustments, such as adjustments to the interior or exterior doors, drawers, latches will be performed at no cost to you by your selling dealer during the first 90 days of warranty coverage; thereafter, such adjustments are your exclusive responsibility as normal maintenance.

What Is Not Covered

1. Tires, batteries, stereo, television, range/stove, furnace, refrigerator, air conditioner, toilet, water heater, microwave, generator, glass breakage, axle alignment, and other materials, parts and components warranted by persons or entities other than Airstream. Please refer to the warranties of component manufacturers for terms and conditions of coverage;
2. Components of the multiplex systems, including monitoring and control, and related hardware and software manufactured and/or warranted by persons or entities other than Airstream.
3. Accessories and equipment that are working as designed, but which you are unhappy because of the design;
4. Any part or component of the travel trailer that was not manufactured or installed by Airstream;
5. Normal deterioration due to wear or exposure, including but not limited to upholstery, flooring rust, corrosion, oxidation, and cosmetic blemishes;
6. Normal maintenance and service items, including but not limited to light bulbs, fuses, lubricants, sealants and seals, door adjustments, and awning tension;
7. After-market equipment or accessories installed on the trailer after completion of manufacture by Airstream, or any defects or damage caused by such items;
8. Travel trailer not purchased through an authorized dealer of Airstream and travel trailers purchased directly or indirectly through auction, salvage, repossession, or other non-customary sale means;
9. Any travel trailer used other than for temporary recreation purposes, including, but not limited to, use of the travel trailer for residential, rental, business and commercial purpose or any travel trailer purchased by, registered by, or titled in the name of a business association (such as any LLC, corporation, or partnership). If the travel trailer owner or user files a tax form claiming a business or commercial tax benefit or income related to the travel trailer, it shall be irrefutable that the travel trailer has been used for rental, commercial or business purposes.
10. Defects or damage caused by, in whole or in part, or in any way related to: Accidents, misuse (including off-road use), or negligence; Failure to comply with the instructions set forth in any owner’s manual provided with the travel trailer; Alteration or modification of the travel trailer except such alterations or modifications approved in writing by Airstream; Acts of God or other environmental conditions, such as lightning, hail, salt causing rust, or other chemicals in the atmosphere; De-icing agents or other chemicals applied to the travel trailer; Failure to properly maintain or service the travel trailer, including but not limited to the maintenance of lubricants, sealants, and seals; Condensation and the results of condensation including water damage and the growth of mold or mildew. Mold and mildew are natural growths given certain environmental

General Information

conditions and are not covered by the terms of this Limited Warranty; The addition of weight to the travel trailer that causes the total weight to exceed applicable weight ratings, or addition of weight causing improper distribution of the weight of the travel trailer; Failure to seek and obtain repairs in a timely manner; Failure to use reasonable efforts to mitigate damage caused by defects; Failure to properly ventilate the travel trailer; Improper electric power supply or improper travel trailer hookup to other facilities; Acts or omissions of any person or entity other than Airstream. (Note: An irrefutable presumption arises that the travel trailer has been used for commercial and/or business purposes if the travel trailer owner or user files a tax form claiming any business or commercial tax benefit related to the travel trailer, or if the travel trailer is purchased, registered or titled in a business name.)

11. Software embedded in Airstream products; mobile applications and other software which may be downloaded to smartphones and other devices; advanced monitoring, control, and other services offered by or on behalf of Airstream in connection with such embedded software, mobile applications, and downloadable software; and data transmission, hotspot, and other connectivity services associated with your travel trailer.

Obtaining Warranty Service

In order to obtain warranty service under this Limited Warranty, the owner must do all of the following:

1. Owner and dealer representative must complete, sign, and return the Customer Performance Checkout within 10 days from delivery of the trailer;
2. Notify Airstream or one of its authorized, independent dealers, of any claimed defect within the warranty period or 10 days thereafter;
3. Provide notification of a defect within 10 days of discovery of that defect; and
4. Promptly return the travel trailer to an authorized Airstream dealer or Airstream for repairs.

If you believe a defect covered by this Limited Warranty still exists after an attempted repair by an authorized Airstream dealer, you must contact Airstream in one of the following manners, and specify:

1. The complete serial number of the travel trailer;
2. The date of original purchase and the date of original delivery;
3. The name of the selling dealer; and

4. The nature of the problem and the steps or service which have been performed.

Email: support@airstream.com

Phone: (937) 596-6111

Mail: AIRSTREAM, INC., 428 West Pike Street, P.O. Box 629, Jackson Center, Ohio 45334-0629, Attention: Owner Relations Department

Airstream may direct you to an authorized Airstream dealer, or may request that you bring your trailer to the Airstream factory in Jackson Center, Ohio for repairs.

Airstream does not control the scheduling of repairs at its authorized Airstream dealers, and repairs at the Airstream factory may not be immediately available. Therefore, you may encounter delays in scheduling repairs and/or completion of repairs. All costs associated with transporting the travel trailer for any warranty service shall be the sole responsibility of the owner.

Events That Discharge Airstream's Obligations Under This Limited Warranty

Misuse or neglect, accidents, unauthorized alteration, failure to provide reasonable and necessary maintenance (see Owner's Manual), damage caused by off road use, collision, fire, theft, vandalism, explosions, overloading in excess of rated capacities, and use of the travel trailer for commercial, business, or rental purposes shall discharge Airstream from any express or implied warranty obligation.

Legal Remedies

Exclusive jurisdiction for deciding legal disputes relating to alleged breach of express warranty and breach of implied warranties arising by operation of law as well as those relating to representations of any nature rests in the courts within the state of manufacture, which is Ohio. Also, this limited warranty shall be interpreted and construed in accordance with the laws of the State of Ohio. Any and all claims, controversies, and causes of action arising out of or relating to this limited warranty, whether sounding contract, tort or statute, shall be governed by the laws of the State of Ohio, including its statute of limitations, without giving effect to any conflict of law rule that would result in the application of the laws of a different jurisdiction. If state law gives you additional rights that conflict with any term of this limited warranty, your state law applies over inconsistent warranty terms. For example, if you took delivery of your RV in California, the Song Beverly warranty act applies because it cannot be waived.

Airstream Limited Warranty Excludes

Normal Wear

Items such as curtains, upholstery, floor coverings, window, door, and vent seals will show wear or may even wear out within the 3-year warranty period, depending upon the amount of usage, weather, and atmospheric conditions.

Accident

We strongly urge our dealers and customers to inspect the trailer upon receipt of delivery for any damage caused by accident while being delivered to the dealer, or while it is on the dealer's lot. Damage of this nature becomes the dealer or customer's responsibility upon acceptance of delivery, unless Airstream is notified and the person making the delivery verifies the damage. Glass breakage, whether obviously struck or mysterious, is always accidental and covered by most insurance policies.

Abuse

Lack of customer care and/or improper maintenance will result in early failure for which Airstream cannot be held responsible.

Chemical Gassing

Chemical gassing is not a "Defect" in your recreational vehicle and is not covered by the Limited Warranty. Please follow the recommendations in this manual to address this concern.

Exposure

Not unlike a car, the steel parts of a trailer can and will rust if subjected to prolonged exposure to moisture, salt air, or corrosive air-borne pollutants without repainting. Aluminum oxidizes when unprotected under similar conditions, and refinery chemicals of a sulfurous nature are harmful to finishes if not washed off periodically. Extremely hot or direct sunlight will deteriorate rubber and fade curtains and upholstery. Conditions of this nature, although they may be normal for the area, are beyond Airstream's control and become the responsibility of the owner.

It is the responsibility of the owner to take such preventative measures as are necessary to maintain the exterior caulking and sealer of your unit. It is the responsibility of the owner to use reasonable, prudent care to prevent foreseeable secondary damage from rain, plumbing leaks, and the natural accumulation of moisture in your unit, such as a delaminated floor; stained upholstery, carpeting, or drapes, mold formation and growth, furniture damage, etc. Mold is a natural growth, given certain environmental conditions, and is not covered by the terms of the Limited Warranty.

Overload

Damage due to loading, either beyond capacity or to cause improper towing because of improper balance, is beyond Airstream's responsibility. The Airstream trailer is engineered to properly handle the gross vehicle load rating on the certification label. Load distribution has a definite effect upon the towing characteristics and attitudes of the trailer. Level hitch installations are a necessity, and very important on a tandem axle trailer. There are limits to the amount of load that can be safely transported, depending upon speed and road conditions, and reasonable cause to believe these factors have been exceeded could void the Airstream warranty. For additional information on the loading of your trailer, consult this Owner's Manual or gross vehicle weight rating plate.

The axle is manufactured to a tolerance of 1-degree camber and 1/8 in. toe-in. These tolerances will only change if the trailer is subjected to abuse, such as dropping off a sharp berm, striking a curb, or hitting a deep hole in the road. Such damage could be considered as resulting from an accident, of which risks are not covered under the warranty. Abnormal tire wear and/or wheel alignment resulting from such damage is not covered under the terms of the warranty.

General Information

Service

Coach-Net® Roadside Assistance



Every new Airstream comes with a three-year, transferable subscription to Coach-Net which includes a long list of premium services to help quickly solve issues or learn about your Airstream.

To learn more, scan the QR code above, navigate to <https://www.airstream.com/owners/coach-net/>, or call Coach-Net at 855-817-1885. On-call technicians are always ready to answer questions.

Service Centers

Before leaving the factory, every vital part of the trailer is tested for performance. Each test is signed and certified by an inspector. After the trailer arrives on your dealer's lot, all vital parts and systems are again tested. When you take delivery of your new trailer, you will receive a complete check out.

At that time, a specified list of performance checks on your trailer equipment will be conducted, and any deficiencies you have experienced since taking delivery will be corrected.

Please contact your dealer if your trailer needs service. Major service under your Airstream Limited Warranty is available through our nationwide network of Airstream Dealer Service Centers. To find a dealer, please visit, www.Airstream.com to use our dealer locator.

Occasionally, dealerships change, or new dealers are added that may not appear on the website immediately. Please note that all centers operate on an appointment basis for the utmost efficiency.

When you require service for your trailer from the Airstream Factory Service Center, or a Certified Dealer Service Center, please contact the service manager for an appointment, and inform them if you are unable to keep the appointment date, or wish to change it. Service may be arranged at the Factory Service Center by contacting the Service Coordinator at:

Airstream Factory Service Center,

428 West Pike Street

P.O. Box 629

Jackson Center, Ohio 45334-0629

Phone: (937) 596-6111 or (877) 596-6111

NOTE

Connected RV and Smart RV Control features and systems may be turned off while in a service facility for the safety of our technicians. You might have to re-pair your personal device after service appointment.

Reporting Safety Defects

If you believe that your vehicle has a defect which could cause a crash or could cause injury or death, you should immediately inform the National Highway Traffic Safety Administration (NHTSA), in addition to notifying Airstream Inc.

If NHTSA receives similar complaints, it may open an investigation, and if it finds that a safety defect exists in a group of vehicles, it may order a recall and remedy campaign. However, NHTSA cannot become involved in individual problems between you, your dealer, or Airstream Inc.

To contact NHTSA, you may either call the Vehicle Safety Hotline toll-free at 1-888-327-4236 (TTY: 1-800-424-9153), go to www.safercar.gov, or write to:

Administrator,

NHTSA,

1200 New Jersey Avenue, S.E.,

Washington, DC 20590.

You can also obtain other information about motor vehicle safety from www.safercar.gov.

Camping

Suggested Pre-Travel Check List

Interior

1. Turn off water pump switch.
2. Close windows and vents.
3. Lock all interior cabinet doors.
4. Latch refrigerator door. (Seal containers first.)
5. Hold down or securely stack all loose, hard, and sharp objects.
6. Fasten sliding and foldette doors.
7. Drain toilet bowl.
8. Turn off interior lights.
9. Set table in upright position.
10. Pull up or retract step.
11. Lower blinds.
12. Secure and lock main door.

Exterior

1. Disconnect and stow the electrical hookup cord, and the sewer (flush out), and water hookup hoses.
2. Turn off gas at LP tanks.
3. Retract stabilizing jacks.
4. Check hitch for proper attachment.
5. Check safety chains and breakaway switch cable.
6. Fully retract hitch jack. Remove and stow jack stand or wood block.
7. Check clearance and stoplights.
8. Check lug nuts.
9. Check tires for correct pressure.
10. Adjust tow vehicle mirrors.
11. Pull forward about 50 ft., test brakes, and check site for forgotten objects and cleanliness.

Trailer Equipment and Accessories

1. Water hose, 5/8 in. high pressure, tasteless, odorless, non-toxic, (2 25-ft. sections)
2. Y connection -- water hose.
3. Sewer hose with clamp.
4. Drain cap with hose drain.
5. Holding tank cleaner and deodorizer.
6. Power cord adapter, 50 to 30-amp capacity.
7. 30 ft. electric cord, 50-amp capacity.
8. Woodblocks for leveling.
9. Wheel chocks.
10. Hydraulic jacks.
11. Cross-type lug wrench and a torque wrench.
12. Quality tire gauge.
13. Emergency road warning triangle.

Motoring Essentials

1. Display the tow vehicle and trailer registration properly.
2. Carry driver's license.
3. In Canada, bring along a non-residence liability insurance card and your passport.
4. In Mexico, you must have special auto insurance.
5. Carry an extra set of the ignition and truck keys in a separate pocket, or in your wallet.
6. Keep an operating flashlight with fresh batteries in the glove compartment.
7. Pack the trunk so that you can reach the tools and spare tire without completely unpacking.
8. Keep sharp or hard articles securely packed.
9. Carry a first-aid kit.
10. Carry your pet's dish, food, leash, and health and registration papers.

General Information

Overnight Stop

Airstream owners have parked virtually in every place imaginable, from filling stations to farmlands. In time, you'll develop a knack for spying wonderful little roadside locations by turning off the main highway and exploring.

There are many modern parks, including State, County, and Federal parks, with good facilities where you might obtain hookups of electrical, water, and sewer connections. Directories are published which describe in detail these parks and tell what is available in the way of services and hookups.

On overnight or weekend trips, chances are you will not use up the capacity of the sewage holding tank, deplete the water supply, or run down the batteries that supply the 12-volt current.

On a longer trip, when you have stayed where sewer connections and utility hookups were not available, it will be necessary for you to stop from time to time to dispose of the waste in the holding tank and replenish the water supply. Many truck stops and gas stations, chain and individually owned, have installed sanitary dumping stations for just this purpose. Booklets are available that list these dumping stations.

When stopping for the night, your Airstream is built to be safely parked in any spot that is relatively level and where the ground is firm. Your facilities are with you. You are self-contained. Unless the tow vehicle is needed for transportation, it is not necessary to unhitch.

⚠ DANGER

At each campsite, make sure you have not parked in such a manner as to block the operation of the escape window by being too close to trees, fences, or other impediments. Scenic views are one reason for traveling, but don't park so the beautiful lake or steep cliff is just outside your escape window.

Choose the most level parking spot possible. Stabilizing jacks or blocks may not be required for an overnight stay. However, if you put the jack pad on the hitch jack and run the hitch jack down to take the weight off the tow vehicle's springs, it will provide some stability. If you must park on a slope, park facing downhill. It is easier to level the trailer this way.

All you need to do to enjoy the self-contained luxury of your Airstream is to turn on the LPG and light any appliance pilot lights.

Before moving on, check your campsite, both for cleanliness, and to be sure you have not left anything behind. Turn off the gas supply and make sure everything is properly stowed. Use your pre-travel check list and you are ready for more travel adventure.

Extended Stay

Making a long trip in your Airstream is not very different from making a weekend excursion. Since everything you need is right at hand, you are at home wherever you go. When packing for an extended trip, take everything you need, but only what you need.

When you plan to stay in the same place for several days, weeks you will want your trailer to be as level and steady as possible. Check the attitude with a small spirit level set on the inside work counter or the trailer hitch A-frame. If a correction is necessary, you must level from side to side first. This can be done easily by backing the trailer up onto one or more 2 x 6 boards. We do not recommend placing tires in a hole to level.

Leveling

Block or chock the wheels to keep the trailer from rolling. Level from front to rear by disconnecting the hitch from the tow vehicle, putting the jack pad under the hitch jack, and adjusting the jack up or down until the trailer is level. Use stabilizing jacks at all four corners, as shown in the diagram, to eliminate the natural spring action of the axles.

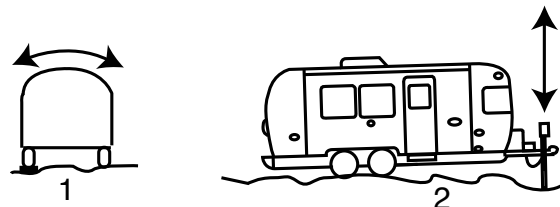

1. Side to Side
2. Front to Rear

Stabilizing Jacks

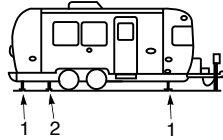

1. Stabilizing Jack Location
2. Lifting Jack Location

⚠ WARNING

Stabilizing jacks should only be used to stabilize the trailer. Do not use jacks to lift the trailer.

⚠ WARNING

Whenever the trailer must be lifted with a jack, as when changing a tire, always place the lifting jack under the main frame rail. A label is provided to indicate the proper position for the jack. Never use stabilizing jacks to lift the trailer.

For more information on jacking, [see Tire Changing on page 8-5.](#)

Effects Of Prolonged Occupancy

Your trailer was designed primarily for recreational use and short-term occupancy. If you expect to occupy the trailer for an extended period, be prepared to deal with condensation and the humid conditions that may be encountered.

Moisture can condense on the inside surfaces of the trailer during cold weather when relative humidity of the interior air is high. This condition is increased because the insulated walls of a recreation vehicle are much thinner than house walls. Also, the relatively small volume and tight, compact construction of modern recreational vehicles means the normal living activities of even a few occupants will lead to rapid moisture saturation. Estimates indicate a family of four can vaporize up to three gallons of water daily through breathing, cooking, bathing, and washing. Unless the water vapor is carried outside by ventilation or condensed by a dehumidifier, it will condense on the inside of the windows and walls as moisture, or in cold weather, as frost or ice. It may also condense out of sight, within the walls or the ceiling, where it will manifest itself as warped or stained panels.

Appearance of these conditions may indicate a serious problem. When you recognize the signs of excessive moisture and condensation in the trailer, action should be taken to minimize their effects.

Tips To Control Condensation

Allow excess moisture to escape to the outside when:

- Bathing, washing dishes, hair drying, etc.
- Laundering, using appliances, and using non-vented gas burners.
- Cooking (Always use the stove vent hood).

Avoid dead air spaces by:

- Using a fan to keep air circulating.
- Leaving closet and cabinet doors partially open.

To help alleviate cold weather condensation:

- Keep the temperature as reasonably cool during cold weather as possible.
- Allow your trailer to breathe; do not make it airtight.
- Allow some warm air to be removed and some cool outside air in.
- Do not allow the furnace to recycle humid interior air; provide reasonable ventilation.

In hot weather, starting the air conditioner early will help remove excess humidity from the air while lowering temperatures.

NOTICE

Your trailer is not designed, nor intended, for permanent housing. Use of this product for long-term or permanent occupancy may lead to premature deterioration of structure, interior finishes, fabrics, carpeting, and drapes. Damage or deterioration due to long-term occupancy may not be considered normal, and may, under the terms of the warranty, constitute misuse, abuse, or neglect, and may therefore reduce the warranty protection.

General Information

Molds

Molds are microscopic organisms that naturally occur in virtually every environment, indoors and out. Outdoors, mold growth is important in the decomposition of plants. Indoors, mold growth is unfavorable. Left unchecked, molds break down natural materials such as wood products and fabrics. Protect your investment by understanding the potential risks mold imposes.

Contributing Factors To Mold Growth

For mold growth to occur, temperatures, indoor or outdoors, must be between 40° and 100°F, and must also have a source of moisture, such as humidity, standing water, damp materials, etc. Indoors, the most rapid growth occurs with warm and humid conditions.

Inhibiting Mold Growth

By controlling relative humidity, the growth of mold and mildew can be inhibited. In warm climates, use of the air conditioner will reduce the relative humidity. Vents are located in the bathing and cooking areas. Constant use of these vents is advised during food preparation and bathing, even during colder weather. Additionally, opening a window during these activities will assist in ventilation. In extremely humid conditions, the use of a dehumidifier can be helpful.

Frequent use of your trailer or cleaning regularly are important preventive measures. Additionally, any spills should be wiped up quickly and dried as soon as possible. Avoid leaving damp items lying about. On safe surfaces, use mold-or mildew-killing cleaning products. Check sealants regularly, and reseal when necessary to avoid water leaks. Proper preventive maintenance to the trailer and its accessories, as described both in this manual and in accompanying literature, will provide the best protection to the trailer.

For more information about controlling moisture in the trailer, [see Tips To Control Condensation on page 3-9.](#)

NOTICE

If using a dehumidifier, please read and follow all manufacturer instructions and recommendations for the use and cleaning of the dehumidifier.

Waste Water System

The main parts of the waste water system are the toilet, holding tanks, and tank dump valves; [see Black and Gray Water Tank Draining on page 8-15.](#) The system is designed to provide complete self-contained toilet facilities, while on the road or parked, without being connected to a sewage line. It may also be used in the stationary position while connected to a sewage hose.

Keep the dump valves closed with either method and empty the tanks when they are nearly full. The idea is to send a large volume of water through the tanks and hose at the same time to float solids away.

After the sewage tank has been emptied, close the dump valves and put approximately 5 gallons of water in the sewage holding tank using the black tank flush inlet. This will spray the interior of the tank with water and help prevent solids from building up in the sewage holding tank. The addition of a deodorizing agent like Aqua-Kem will help prevent odors.

Should you ever have a buildup of solids, close the valves, fill the tanks about 3/4 full with fresh water, drive a distance to agitate the solids, and drain the tanks.

Things Not To Put Into Toilet Or Drains

- Facial tissues and feminine hygiene products (they do not dissolve like toilet paper).
- Automotive antifreeze, ammonia, alcohols, or acetone.
- Table scraps or other solids that may clog the drains.

28RB

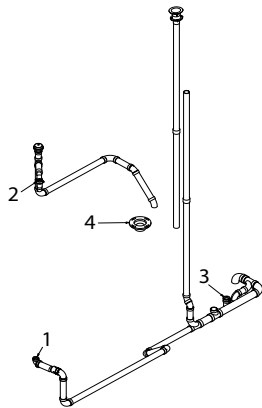

1. Galley Drain
2. Lavatory Drain
3. Shower Drain
4. Toilet Drain

Winter Traveling

Traveling in sub-freezing temperatures will require certain precautions to protect the plumbing system and your personal belongings from being damaged by freezing.

Whenever possible, the heat should be kept set to a constant temperature. It is easier for the furnace to keep a constant room temperature than allow the trailer temperature to drop to 50°F, and then attempt to raise it to room temperature.

Some states do not allow LPG to be turned on while moving. While traveling in these states, simply use your common sense. How cold is it? How long will it be before you can turn the heat back on? Is the temperature dropping or rising? Remember, when towing at 50 MPH, the wind chill factor will cause the interior of the trailer to cool much faster than a trailer that is parked.

1. When parked in sub-freezing temperatures, make sure to keep a full supply of LPG and plug into an external AC power source whenever possible.
2. If your stay is longer than overnight, you should try to have 120-volt electricity available. Minimize the use of electricity if a 120-volt power source is not available.
3. Leave cabinet doors, wardrobes, and bed doors partially open to allow warm air to circulate around plumbing lines and fixtures. Insulate and/or wrap your exterior water lines with heat tape.

NOTICE

Drain and winterize all models if the water systems are not being used during winter traveling; see [Winterizing and Storage](#) on page 8-16.

AIRSTREAM®

Section 4 FLOOR PLANS AND SPECIFICATIONS

FLOOR PLANS4-2
28RB Queen4-2
28RB Twin.4-2
SPECIFICATIONS4-3
Specifications Chart4-3
Specification Tags.4-4
Measuring Hitch Ball Height4-4

Floor Plans And Specifications

Floor Plans

28RB Queen



28RB Twin



Specifications

Specifications Chart

NOTE

All product information and specifications listed are as accurate as possible at the time of printing. Since we continually strive to improve our products, all specifications are subject to change without notice. All capacities are approximate and dimensions are nominal and are checked and updated throughout the model year.

Item	Model
	28RB Queen/Twin
Exterior length	28' 2"
Exterior width	8' 5.5"
Exterior height with A/C	9' 7"
Interior width	8' 1"
Interior height with A/C	6' 7"
Hitch ball height	19"
Hitch ball size	2 5/16"
UBW (lbs. with LP & batteries)	6825
Hitch weight (lbs. with LP & batteries)	925
GVWR (lbs.)	7600
NCC (lbs.)	775
Fresh water tank (gal.)	37
Gray water tank (gal.)	34
Black water tank (gal.)	34
Lug nut torque (Max), aluminum wheels (ft lbs.)	110
Lug nut torque (Max), steel wheel (spare) (ft lbs.)	100
Tire size	ST225/75R15
Tire Max cold* inflation pressure (psi)	80
Tire Max load rating (lbs.)	2830

*The term *cold* refers to how long a tire has sat idle. *Max cold inflation pressure* should be checked in the morning (after sitting idle for at least three hours) before driving more than a few miles, or before rising ambient temperatures and the sun's radiant heat can affect tire pressure.

Floor Plans And Specifications

The Unit Base Weight (UBW) and Net Carrying Capacity (NCC) weights listed in the Specification Chart are for the base unit with LP and batteries included.

Gross Vehicular Weight Rating (GVWR) is the maximum permissible weight of this trailer when fully loaded. It includes all weight at the trailer axle(s) and coupler.

UBW is the dry weight of the base unit without options.

NCC is equal to GVWR minus UBW. Gross Axle Weight Rating (GAWR) is the value specified as the load carrying capacity of a single axle system, as measured at the tire-ground interfaces.

Specification Tags

For precise cargo capacity, refer to the Cargo-Carrying Capacity tag on the inside of the screen door. The **WEIGHT OF CARGO SHOULD NEVER EXCEED** numbers shown on the tag, which is the maximum weight of cargo you can load and carry in your specific trailer as built with its options.

Located on the front roadside of your trailer are the Tire and Loading, and Vehicle Manufacturing tags.

The Tire and Loading information tag lists the Size and Cold Inflation Pressure of the tires on your vehicle, the weight of your trailer as manufactured, and the GVWR.

The Vehicle Manufacturing tag lists the Size of tires and wheel rims, Maximum Cold Inflation pressures, the Vehicle Identification Number (VIN), and GAWR.

Measuring Hitch Ball Height

The proper height will vary according to the weight you carry and the tires you use. However, checking the height on your trailer is relatively easy:

1. With trailer parked on fairly level ground, measure from ground to bottom of frame, front and rear.
2. Adjust front jack until measurements are equal.
3. Now, measure from ground to the inside top of ball coupler. This figure is the hitch height. The hitch ball is then usually set 1/2 to 1 in. higher, according to the spring rate of your tow vehicle, to allow for it to settle when the trailer is hitched up.

AIRSTREAM®

Section 5 INTERIOR

GENERAL INFORMATION AND CLEANING	5-3	ELECTRICAL	5-7
Upholstery	5-3	Battery/12-Volt System Information	5-7
Curtains and Shades	5-3	Multiplex System	5-8
Interior Woodwork	5-3	Systems Controlled By CZone®	5-8
Interior Aluminum Skin	5-3	Menu	5-8
Counter Area	5-3	Favorites	5-8
Cutting Board, Sink Cover, and Knife Block	5-3	General Operating Controls	5-9
Sinks	5-4	Ceiling and Directional Lighting	5-9
Vinyl Flooring	5-4	Battery Disconnect Switch	5-10
Interior Doormat and Rug Selection	5-4	Inverter	5-10
Shower Stall	5-4	Power Center	5-10
Shower Wand	5-4	12-Volt Power Circuits	5-11
Retractable Clothesline	5-4	Converter Operation	5-11
Storage Tips	5-4	120-Volt AC Panel Board	5-11
Dinette Table and Bed Conversion	5-5	Converter Cooling System	5-11
Sofa	5-5	Automatic Micro-Controller Operation	5-11
PLUMBING	5-5	120-Volt Electrical System	5-12
Water System (Self-Contained)	5-5	City Power	5-12
Water Pump	5-5	Converter	5-12
Draining System	5-6	Ground Fault Circuit Interrupter (GFCI)	5-13
Fresh Water Lines and Tanks	5-6	GFCI Breaker Test	5-13
Drain and Waste System	5-6		
Toilet	5-6		
Deodorizers and Biological Chemicals	5-6		
Faucets	5-7		
Galley Faucet	5-7		
Lavatory Faucet	5-7		
Faucet and Shower Cleaning and Care	5-7		

Section 5 Interior

ENTERTAINMENT SYSTEMS5-14	APPLIANCES5-18
TV and Sound System5-14	Maintenance5-18
TV and Audio Component Pairing5-14	Air Conditioner5-18
Smartphone and Stereo Pairing5-14	Air Conditioner Filters5-18
USB Stereo Connection5-14	Heat Pump5-19
Blu-ray/DVD Player and Streaming Device Connection5-14	Cooktop5-19
TV/Radio Antenna5-15	Ceiling Vent Fan5-19
Cable/Satellite Connection5-15	Thermostat and Rain Sensor5-19
SMART RV CONTROL TECHNOLOGY5-16	Cleaning Instructions5-20
Smart RV5-16	Exhaust Vent5-20
Connected RV5-16	Operation5-20
Router5-16	Cleaning Instructions5-20
Antenna5-16	Fuse5-20
Ethernet Connection5-16	Furnace5-20
Privacy Disclaimer5-17	Microwave Ovens5-21
		Monitor Panel5-21
		Viewing Battery Voltage5-21
		Refrigerator5-22
		Solar System5-22
		Smart Shunt5-22
		Calibration5-23
		Water Heater5-23
		Common Error Codes5-23

General Information and Cleaning

The interior of all Airstream trailers has been designed for comfort, convenience, durability, and appearance. How you use it and how you take care of it, naturally, depends on you. However, if you learn to operate the interior components and take care of them and the trailer properly, this knowledge will add to your pleasure, as well as the long life of your trailer. All material should be professionally dry cleaned to remove any overall soiled condition.

Upholstery

The sofa and dinette cushions are covered with Performance Boucle, a richly textured, nubby fabric made from curled fibers that's cozy, durable, and easy to clean. For slipcover care: machine wash cold, gentle cycle, chlorine or non-chlorine bleach as needed. Rinse thoroughly, air dry; or spot clean with a damp white cloth and natural soap in lukewarm water using a blotting motion. For upholstery care: spot clean with a damp white cloth. Blot to remove excess water. Air dry or consult with a professional upholstery cleaner.

Curtains and Shades

The curtains are on a track. Undo the velcro at the seams to slide them open. Airstream recommends dry cleaning only for the curtains. To remove them, remove the top screw from the endcap of the curtain track, pull the endcap off, and slide the curtains off.

Spot clean the shades only. Prepare a solution of warm water and a mild detergent. Dampen a clean cloth in the solution and wring it out. Dab the spot with the dampened cloth until it is gone. **Do not rub the fabric!** Allow the shade to dry in the completely lowered position.

Interior Woodwork

The finish on the interior woodwork is a high quality furniture finish and should be treated as any fine furniture finish. Use a high quality furniture cleaner which does NOT contain ammonia or bleach. One good choice is Murphy Oil Soap Clean and Shine.

Interior Aluminum Skin

Interior aluminum skin can be cleaned by washing skin with any mild non-abrasive soap or detergent. Cleaning should be followed by a thorough clean water rinse. Drying the unit with a chamois or a soft cloth may prevent spots and streaks.

Do not use abrasive cleaners or utensils on the aluminum skin as it is coated with a clear coat that could be damaged.

NOTICE

When washing or polishing your trailer, always wipe with the grain of the metal.

Counter Area

The countertops are made of a solid surface and can be cleaned with soap and water, or you can use a common solvent on tough spots. Do not use abrasive cleaners since they could scratch the surface. A protective pad should always be used under hot utensils or pans. A light sanding of minor damaged areas can repair the counters. The color of the material is constant and not just a surface coat.

Cutting Board, Sink Cover, and Knife Block

The cutting board, sink cover, and knife block all come pre-seasoned with mineral oil, and ready to use. For proper care and maintenance, be sure to continually season your board at least once a month with a food safe oil or wax (a complimentary bottle has been provided).

After use, be sure to clean the items of any liquids and avoid: putting the boards in the dishwasher, use of bleach or other chemicals, laying the cutting board flat before it dries. For proper cleaning, clean the board in the sink using soap, warm water, and a rag or scrub to clean. Immediately towel or air dry upright so all sides can dry equally.

Water spots and other small stains can be removed by using a 220 grit or higher sandpaper. Lightly sand left to right along the grain of the wood until the spot is no longer visible. After sanding, use a rag to reapply mineral oil to the surface. Some spots can be buffed out using mineral oil.

NOTICE

Make sure to properly stow these items before traveling. Items left on the countertops can cause damage during transit.

Sinks

Rinse and wipe sinks clean with a soft cloth after each use. Clean sinks thoroughly at least once a week with a mild soap. For the galley sink, use either mild soap or a non-abrasive stainless-friendly cleaner and a non-abrasive sponge or rag; rinse thoroughly to remove all cleaning residue. Always clean with the grain.

NOTICE

The stainless-steel galley sink has a protective layer. To prevent damage, please refer to your Owner's packet and read the manufacturer's detailed cleaning instructions. Do not use bleach. Do not use abrasives like steel wool or scouring pads as they will damage your sink. Do not leave steel or cast-iron cookware in the sink.

Vinyl Flooring

Use a soft broom to sweep the floor. A vacuum cleaner may damage the flooring, especially the type that use beater bars. In most cases, a clean damp cloth or mop will suffice to clean dirty flooring. Use a neutral floor cleaner like Tarkett SureShine® Floor Cleaner to clean the floor. Do not use a wire brush or nylon scouring pads, furniture polish, spirit-based polish, powder or liquid abrasive cleaners, bleach or other strong detergents. Scuffs, dirt, and spillages should be cleaned up as soon as possible.

NOTICE

The use of certain cleaning agents, including but not limited to powdered abrasives, solvents, and industrial strength cleaners is not recommended. Always follow the manufacturer's instructions. Check that the cleaner/polish is suitable for use with cushioned vinyl floor coverings.

Interior Doormat and Rug Selection

To avoid staining or discoloration of vinyl flooring, only use doormats or rugs made of natural fibers. The rubber-backed mat provided by Airstream is suitable for outdoor use only.

NOTICE

Rubber or latex-backed mats or furniture with rubber feet may stain or discolor vinyl flooring.

Shower Stall

To clean your fiberglass shower stall unit, use warm water and one of the stronger liquid detergents. Do not use abrasive cleaners as they may scratch and dull the surface of your unit. Stubborn stains can be removed with solvents such as turpentine, paint thinner, or acetone. Restore dulled areas by rubbing with an automotive type liquid cleaner, then, put the soft glow back into your unit with a light application of liquid wax. For models with Decotone wall tile installed use soft non-abrasive detergents and nylon brushes. Stubborn stains may require the use of hypochlorite bleach dissolved in water. Avoid the use of strong bleachers, organic detergents and abrasive brushes, these could discolor and scratch the surface.

⚠ WARNING

Applying wax to the base of the shower floor is not recommended, as this could create an unsafe surface.

Shower Wand

The shower wand is designed to give maximum flexibility in usage, and provides for water-saving techniques when using your trailer on self-containment. It can be held in the hand and moved about the body. Normally, the best water conservation procedure is to wet the entire body and then turn the water off. Apply soap, lather thoroughly, and then rinse the soap off.

Retractable Clothesline

A retractable clothesline is installed for your convenience in the shower stall. To use, pull the line from the base and attach it to the holder on the opposite wall. Turning the nut on the base to tighten.

Storage Tips

Galley cabinets should have the heaviest items stored on the bottom and lighter items overhead. After loading, put skillet and canned goods on the floor or bottom shelf, and cereals and crackers in the overhead roof locker. Use unbreakable-type plates and saucers, and consider storing your dish towels around them.

Clothes hung in wardrobes should be kept on hangers that snap over the clothes rods to keep them from bouncing off on rough roads. Try to avoid large bulky coats. Layers of lighter clothing will usually keep you warmer, are more versatile, and are easier to store.

⚠ WARNING

Keep flammable material away from the furnace and vents

Dinette Table and Bed Conversion

The tabletop is horizontally adjustable for comfort and functionality. Locate the tabletop slide latch on the underside and pull it outward to remove tension. Slide the tabletop side-to-side, in or out, to the desired position. Reengage the latch before using the table. Use the following steps to convert the dinette to a bed.

1. Locate the tabletop slide latch on the underside and pull it outward to remove tension. This allows the top to be centered between the dinette seats as it is lowered.
2. Pull and hold the lever for the pedestal. Push on the top to get it moving downward. Release the lever and continue pushing down, centering the table as you lower it. You will hear a click when the table is fully lowered and latched into position.
3. Reengage the tabletop slide latch and lay the dinette seat backrest cushions over the tabletop to complete the conversion.

To resume using the dinette, remove the cushions and pull the pedestal lever to raise the table (pulling up on the table as necessary).

To clean, use a high quality furniture cleaner which does NOT contain ammonia or bleach.

Sofa

The sofa seats are constructed using Marshall units (pocketed spring coils) within the foam cushions. The system is the latest and greatest when it comes to high-comfort suspension options in furniture. The sofa backs are loose filled granulated foam, which replicates down fill.



An “airplane” style writing table is installed in the curbside armrest. To use, lift up the armrest and rotate the table, up and out over the sofa. Once the table is in position, the armrest can be closed.

Plumbing

Water System (Self-Contained)

Fill the water tank by opening the exterior access door and remove screw cap. A drinking water safe hose can now be inserted. It's a good idea to let the water

run through the hose for a short time to flush it out. Experienced RVers usually fill their tanks with “home” water to avoid strange water that may be distasteful to them. The amount of water in the tank may be checked on the Monitor Panel, or you may fill the tank until water overflows out of the fill.

Open the hot side of the galley or lavatory faucet and turn on the water pump using the main Multiplex control panel. For some time, the open faucet will only sputter. This is because the water heater is being filled and air is being pushed out through the lines. Once the water heater is full, a steady stream of water will flow from the faucet. Now, open a cold faucet. It will sputter for a short time, but will soon expel a steady stream. All other faucets can now be opened until all air is expelled. Once the system is filled with water and the faucets closed, the water pump will shut off. When a faucet is opened, the pump will come back on automatically. If the faucet is just barely open, it is normal for the pump to cycle on and off rapidly.

Water Pump

The water pump is controlled by the Multiplex Control Panel or remote switch located on the bathroom wall; see [Multiplex System on page 5-8](#). When turned on, the water pump's controller maintains a consistent regulated water pressure and steady water flow based on demand.

The water pump is typically left off when hooked up to a city water supply. However, if city water pressure is lower than desired the water pump can be turned on to facilitate increased water pressure, provided there is a supply of water in the fresh water tank. The tank will be depleted by the amount needed to supplement the flow of city water.

Access to the water pump will be necessary for periodic cleaning of the strainer screen; see [Water Pump Access Locations on page 8-14](#) and see [Strainer Cleaning on page 8-14](#).

NOTICE

Road vibration may force a faucet open in transit. Ensure the pump is OFF prior to travel.

NOTE

If water flow is interrupted, check the water supply and turn the pump off and back on.

Draining System

Fresh Water Lines and Tanks

The fresh water system's water lines have low point drain valves and can be drained. The fresh water tank has a valve and can also be drained; [see Fresh Water Tanks and Draining on page 8-14](#).

Drain and Waste System

Your trailer has a drain and waste system that includes waste-holding tanks made from corrosion-free molded plastic, with trouble-free dump valves.

The main (Black Water) holding tank enables you to use the toilet for several days away from disposal facilities. The waste water from the sink, shower, bath and lavatory drains into the auxiliary (Gray Water) holding tank.

Each tank has its own dump valve with both tanks draining through a common outlet. Therefore, only one sewer hose connection is needed when hooking up to a dump station.

Almost all campgrounds will have dumping facilities. Park directories, such as Woodalls and Rand McNally, also list dumping stations; [see Black and Gray Water Tank Draining on page 8-15](#).

Check your monitor panel frequently; [see Monitor Panel on page 5-21](#). When the Black Water holding tank is completely full, sewage cannot be emptied from the toilet bowl. If the Gray Water holding tank is overfilled, drain water may back up into the shower floor pan and cause an unpleasant cleaning job. Never drain the tanks at any place other than an approved dumping station.

NOTICE

Never put wet strength paper towels or tissues in your holding tank since they won't dissolve and can catch in the mechanism of the dump valve. Colored toilet tissue is slower to dissolve than white. Most RV-accessory stores offer tissue designed for RVs that will completely dissolve.

Toilet

The RV toilet in your trailer is a design that has been used for many years. There is only one pedal. This pedal opens and closes the slide mechanism, and opens the water valve.

In normal use, depressing the pedal dumps the sewage and flushes water down the side of the bowl. Water will continue to run into the bowl for a short time after the pedal is released.

When you wish to conserve water, hold the hand-spray head (if equipped) over the bowl and hold down the thumb-operated lever. When depressing the pedal, all the water is routed through the hand-spray.

NOTICE

When you dump the bowl of the toilet, make sure all paper and solids have cleared the slide mechanism before you allow it to close. Failure to do so can cause the groove for the slide to become jammed and the slide will no longer close completely.

Please see the toilet owner's/user manual for warranty and user tips, and maintenance information.

Deodorizers and Biological Chemicals

There are many deodorizers and processing chemicals on the market in tablet, liquid, and powder form. These not only combat odor, but also stimulate the bacteria that works to dissolve the solids and tissues in your waste tank. These chemicals should be introduced through the toilet prior to use per the manufacturers directions. It's also important to always add a few gallons of water by filling the toilet bowl a few times and depressing the foot pedal.

Faucets

Galley Faucet



Airstream Part #602868

Kingston Brass - Model LS8770CTL

Lavatory Faucet



Airstream Part #602867

Kingston Brass - Model LS8230DL

Faucet and Shower Cleaning and Care

All that is needed to clean your faucets and shower hardware is a soft, damp cloth. Airstream does not recommend the use of scour pads, cleansers, or chemicals. The abrasive nature of these substances could damage the finish. A non-abrasive car wax will help to protect the finish.

Electrical

Battery/12-Volt System Information

The major portion of electrical power in your Airstream is 12-volt. The 12-volt current powers all gas appliances for controls and/or ignition as well as lighting. An exception would be the range which has its own ignition source.

All 12-volt current comes through the battery system in the front of the trailer. The batteries are accessible in the battery box on the A-frame of your trailer. Power from the batteries goes to a set of Type 2 thermal breakers. The breakers are tied together by a brass bus bar. One breaker (30 amp) protects the 12-volt tow vehicle charge line coming from the 7-way cord. Another breaker (20 amp) feeds the trailer brakes breakaway switch located near the hitch coupler. A 50-amp breaker feeds the battery disconnect relay. The current leaves the relay and travels to the 12-volt distribution panel, located in the converter, and then to the rest of the trailer. Open the door on the front of the converter, below the refrigerator, to access the fuses. For more information, [see Electrical Diagrams on page 8-19](#).

If you replace a blown fuse and it immediately blows again, do not replace the fuse again until a qualified service technician can correct the problem.

If the replacement fuse holds for a week or more and the gap in the fusible metal is barely melted apart, this usually indicates an overload condition. Reducing the number of lights or appliances used on that particular circuit at the same time could prevent any further fuse failure.

For important battery maintenance information, [see Batteries on page 8-12](#).

Interior

Multiplex System

The Multiplex System provides advanced automation and mobile electrical solutions for your trailer. CZone® is a multiplex network system designed to combine multiple signals across a media to reduce wires and simplify end user control. The system combines all desired functions and controls of the trailer into a central location. Regional control panels are installed to operate specific areas such as; the bedroom, lavatory, and lounge areas. This system communicates through the router to give remote access to the trailer through the Airstream Smart RV Control App.

Mode buttons allow for a single press of the button to control several features of the trailer. Away mode turns off the lights to prepare for departure. Onboard mode will turn on the interior lights.

For Settings, Mode and Alarm definitions, see [Multiplex Controls on page 8-23](#).

Systems Controlled By CZone®

- All lighting (inside and outside)
- Water pump
- Inverter (On/Off)
- Tank monitoring (Fresh, Black, Grey and LPG)
- Fans
- Power awning and awning lights
- Battery disconnect
- Cooling temperature control.

Menu



Pressing the “Menu” button, located at the top left corner of the touch screen, accesses the CZone® sub menus. This Menu will provide the user controls and information ranging from lights and temperature controls to alarms and notifications.

Favorites

The CZone® default screen display is the favorites page. After the screen's initial boot up the favorites page will be displayed. There are multiple favorites pages represented by the dots near the bottom of the touch screen. Swiping left or right will move to the next page. The favorites pages provide quick access to the most commonly used features.

4. Page 1: Displays battery voltage, LP and water tank levels. This page also provides buttons to turn the inverter ON/OFF and displays the status of shore and solar power.

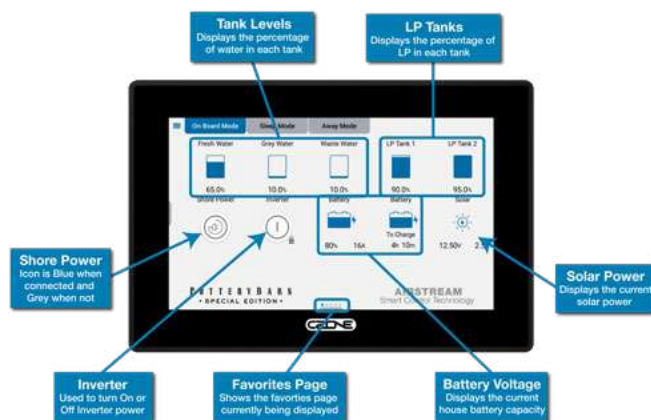

5. Page 2: Swiping left on the screen will display the lighting controls for the travel trailer's exterior lighting. Tap the icon to turn ON/OFF the desired light.



- Page 3: Displays the lighting controls for the travel trailer's interior lighting. Tap the icon to turn ON/OFF the desired light. Some lighting may be dimmable and can be adjusted by touching and holding the icon for two seconds. A secondary screen will appear allowing you to slide UP or DOWN to adjust the brightness.



- Page 4: Displays controls for both the front and rear air conditioning units and the furnace. The AC units can be operated independent of one another, meaning one or both units can be ON or OFF or in different modes. To operate the furnace, the front AC must be set to "AUX" mode.

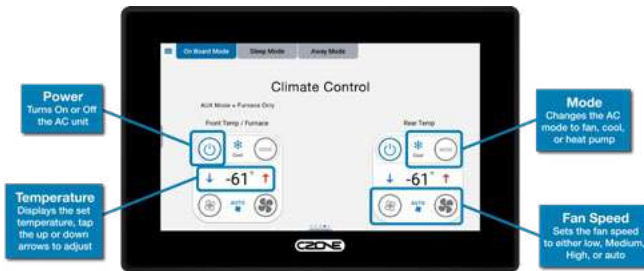

- Page 5: Displays the fan controls to the front ceiling vent fan and the bathroom fan. The ceiling vent fan lid will need to be opened prior to use. The fan is equipped with a rain sensor which will automatically close the lid when the sensor becomes wet.

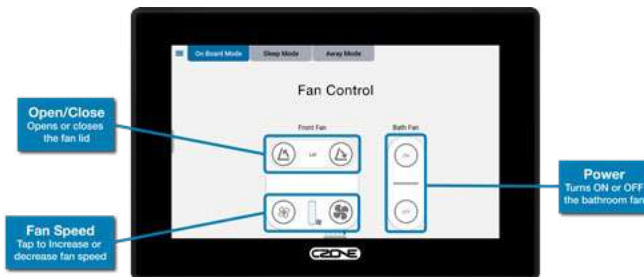

General Operating Controls



The Controls Menu provides a list of everything controlled by the CZone® system. Scroll UP or DOWN on the left side of the screen to view the list. Tap the screen when the feature you want to control is displayed. The right side of the screen will change to display the control options associated with that feature. Some basic feature information will also be displayed.

The filter function is handy in narrowing down the control list to make finding specific features easier. The filtering options are; In Operation, Pumps, Lighting, Power, Fans/Ventilation.

Ceiling and Directional Lighting

All lighting in the Airstream trailer is LED and most will require a replacement fixture should it go out or malfunction. Lighting can be operated from the main touch screen control panel or from regional switch panels throughout the trailer. The Circuit Control Board is located inside a compartment, below the rear dinette seat. Other control panels located throughout the trailer include; at the entry door, bathroom, and bedroom. These panels control an array of lighting along with specific systems in their respective locations; [see Multiplex Controls on page 8-23](#).

If the main control panel or remote switches are not operating check the breaker panel for tripped breakers.

NOTE

Several control switch panels are installed throughout the trailer. Many fixtures can be operated on multiple switches. However, some of the fixtures they control are unique to the area in which they are located. For best use of the Multiplex system Airstream recommends learning the functions of each individual panel. Refer to the owner's manual provided for tips and information on how to use the system.

Battery Disconnect Switch

The battery disconnect is operated by using either the main Multiplex Control Panel or by pressing the  button on the Multiplex panel located at the entry door. You can also operate this function through the Airstream Smart RV Control app. The disconnect switch is used to separate the batteries from the 12-volt distribution panel.

When the trailer is plugged into an external AC power source the 12-volt distribution panel will receive power from the converter and the batteries will be charged through the converter charging system regardless of if the battery switch is in the ON/OFF position.

If the trailer is NOT plugged into an external AC power source and the switch is turned to OFF the batteries are disconnected and the 12-volt fuse panel will not receive power from the converter or batteries. The converter will not charge the batteries when no shoreline power is present. The OFF position is intended for storage of the trailer or when power conservation is desired.

The charge in the 12-volt batteries can be replenished, depending on the tow vehicle, from the tow vehicle alternator through the 7-way cord. This charge will flow to the batteries regardless of the battery disconnect switch position. Likewise, if ON or OFF, the solar panel will still charge the batteries.

NOTE

A 24-Hr circuit provides power to the router even when the battery disconnect is in the “Off” position.

Inverter

The inverter is a DC to AC, 2000 Watt inverter, that converts 12-volt electricity from your batteries into 120-volt power. Operation of the inverter is controlled from the main touch screen on the first favorites page. The inverter powers the TV's/Entertainment devices and additional labeled 120-volt outlets. To operate these outlets, the inverter must be ON, unless connected to shoreline power.

If power is not needed to the outlets or entertainment devices, make sure the inverter is turned OFF to conserve battery power.

NOTE

Overloading the inverter will cause an automatic shutoff to activate. Removing the load will allow the inverter to reset.

Power Center



The power center, located below the refrigerator, transforms 120-volt AC into 12-volt DC. The power center's converter/charging system is the interior low voltage electrical system that enables you to use the interior lights, fans, pumps, and 12-volt appliances, whether operating on self-contained battery power or 120-volt city power. The 12-volt light bulbs give off the same light as regular household bulbs, so that when operating on self-contained battery power, everything works normally except the 120-volt convenience outlets and 120-volt appliances. The converter system is designed to maintain constant output voltages regardless of the variances that occur in city power systems.

⚠ WARNING

The power center is a centralized power switching, fusing, and distribution center. The potential for lethal electrical shock is present in this box. Inadvertent shorts at this box could result in damage and/or injury. All servicing of this box should be done by a qualified Service Technician.

⚠ WARNING

Disconnect/De-energize all main power service, shore power, generator power, and inverter power prior to servicing the breaker panel.

The converter is energized only when the trailer is hooked up to external AC power.

To test the converter, observe the following:

- Confirm 120-volt power is going into converter.
- Disconnect the 12+ wire from the master switch.
- Using a voltmeter, check voltage output between heavy gauge positive and negative wires coming out of converter.
- The voltage should be within 13.6 and 14.6 volts. (The meter of the tester should be calibrated periodically.)

- If converter is not within these voltages, have it serviced by a qualified technician or replace it.

One of these wires is not spliced onto a wire of the same color. It is the backup wire that is yellow in the cable and black in the harness.

A label on the inside of the converter door lists the circuits and what each fuse powers.

12-Volt Power Circuits

The current in the converter system is 12 volts direct current (12 VDC) negative grounded. Power sources that supply 12 VDC current to the system are as follows:

- Main charge line from tow vehicle
- Trailer batteries
- Converter

The power sources listed above are all electrically connected to the 12-volt distribution fuse panel that distributes current to interior branch circuits. The circuits provide power to operate all 12-volt DC lights, pumps, motors, and appliances.

The power converter is a solid-state electronic power supply and is maintenance-free. It is so self-sufficient and quiet that you will probably not know it is working except for the fact that your batteries are always charged, and your 12-volt lights and appliances always work.

If any 12-volt appliance fails to operate, first check your 12-volt distribution fuse block and inspect all fuses.

If a fuse is opened or blown, replace it with the same size fuse (never install a larger fuse). If the fuse opens again, have an electrician or certified RV technician locate the circuit trouble. Replace blown fuses only with the same type and amperage size previously used.

If the power converter is not working, first confirm the RV supply or shoreline cord is plugged in to a live circuit. Then check all the 120-volt breakers in your RV distribution panel to make sure they are on. If the breaker is tripped, follow the instructions to reset the breakers. If the breaker trips again, consult an electrician or certified RV technician.

Converter Operation

The electronic power converter is designed to supply the nominal 12-volt-filtered DC power for all 12-volt-operated devices encountered in RV service. Although the converter is an excellent battery charger, the converter does not require a battery to be connected to it for proper operation.

NOTICE

When installing a batteries, always observe polarity. Connecting a battery in reverse polarity will blow the power converter main fuses.

120-Volt AC Panel Board

The AC panel board section contains the 120 VAC branch circuit breakers for your RV. One of the breakers controls the 120-volt power to the 12-volt converter section. This breaker may also control another branch circuit. Check the label next to each breaker for what each branch circuit breaker controls.

The 120-volt circuits may be turned on by setting their breaker handle up to the ON position, or off by setting the handle down to the OFF position. To reset the tripped breaker, move the handle to OFF then ON.

The system incorporates GFCI breakers that implement an auto self-test functionality. When turned off, these breakers require external AC power to be present, or the AC inverter enabled, before they can be turned back on. If AC power is present from one of these two sources, and the breaker refuses to stay on consult an electrician or certified RV technician.

Converter Cooling System

The power converters electronic fan cooling system is the key to long life and trouble-free operation. The fan is never on more than required to cool electronic components in the converter. You may never hear the fan operate.

Automatic Micro-Controller Operation

The power converters 2-stage switch mode is fully automatic. The converter senses which mode it needs to be in by checking the condition of the batteries . The two modes include:

Absorption Mode: During this mode the converter output is in the 13.6 VDC range. This is the mode that the converter will function at normally. This mode provides the 12 VDC and the current required by the trailer.

Bulk Mode: In this mode, the output voltage of the converter will switch to 14.6 VDC range for a maximum of four hours. If the converter cycles between "Absorption and Bulk modes", there could be a shorted battery cell or other issues.

120-Volt Electrical System

City Power

When your trailer is hooked up to external AC power, the converter system automatically charges the trailer batteries regardless of the position of the battery disconnect switch located on the Multiplex Control Panel. If the 7-way cord is hooked up and, depending on your vehicle, your tow vehicle battery will be charged as well. The speed and degree of charge depends on how much power is used for lights and appliances, as only the surplus goes to charging the battery. If you are making an extended stay, you should keep your trailer hooked up to a 120-volt current if it is available.

While you are connected to external AC power, the wiring is protected by circuit breakers in the breaker panel. The circuit breaker panel for the 120-volt system is located in the converter. In the event of a failure of a 120-volt circuit, first check your trailer circuit breakers and the breaker for the outlet into which your trailer shoreline cord is plugged. If a breaker continues to trip after you have reset it several times, your circuit may be overloaded with appliances or there may be a short in the circuit. Try lessening the load on the circuit. Perhaps an electric griddle, hair dryer, or an electric heater can be turned off. If that does not solve the problem, consult an Airstream Service Center.

The 120-volt electrical system provides power to operate the air conditioner, converter, and 120-volt receptacles for portable appliances. The power is carded through the 120-volt city power flexible cord to the 120-volt distribution panel, and then is distributed to each appliance or receptacle. Exterior outlets for 120-volts are located on the curbside exterior wall.

All wire, components, and wiring methods conform to federal and state requirements.

Converter

The converter system is a transformer designed to maintain constant output voltages regardless of the variances that occur in city power systems. The design eliminates the need for complex electronic sensing systems to charge the batteries, minimizing the possibility of failures and greatly increasing its overall reliability.

In some older parks and other locations where three-pronged outlets are not available, certain precautions to ensure proper grounding and polarity must be taken. These precautions are listed below:

1. Attach the three-pronged plug to a two-pronged adapter. The third conductor line of this adapter has a short wire lead, that must be grounded.
2. For proper grounding, connect the short ground lead to a grounded outlet box or to a cold water pipe. When no water pipe is available, drive a metal rod two feet into the ground and attach the ground lug to it, thus, providing the unit with proper grounding.

To operate self-contained, simply disconnect the power supply cable.

NOTE

When the three-pronged plug can be used, there will be no problems with proper polarity or grounding with a properly wired shoreline outlet.

NOTICE

When operating with city power, make certain that the service is 120-volt and not 240-volt.

Ground Fault Circuit Interrupter (GFCI)

Most states require trailers with exterior 120-volt receptacles and receptacles close to a water sources, such as a faucet, to have a ground fault-circuit interrupter. When properly installed, the GFCI circuit breaker provides reliable overload and short-circuit protection, plus protection from ground faults that might result from contact with a **HOT** load wire and ground.

⚠ WARNING

The GFCI circuit breaker will NOT reduce shock hazard if contact is made between a HOT load wire and a neutral wire or two HOT load wires. GFCI circuit breakers provide protection only to the circuit to which it is connected.

Each GFCI circuit breaker is calibrated to trip with a ground current of 5 milliamperes or more. Since most people can feel as little as 2 milliamperes, a distinct shock may be felt if the need for protection exists. However, the shock should be of such short duration that the effects would be reduced to less than the normally dangerous level. However, persons with acute heart problems or other conditions that can make a person particularly susceptible to electric shock may still be seriously injured. 120-Volt power needs to be present to reset the GFCI breaker.

While the GFCI circuit breaker affords a high degree of protection, there is no substitute for the knowledge that electricity can be dangerous when carelessly handled or used without reasonable caution.

GFCI Breaker Test

Perform this test on the GFI circuit breaker each month and record the date.

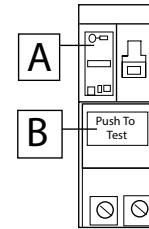

1. With handle A in “ON” position, press PUSH TO TEST button B.
2. Handle A should move to TRIP position, indicating that GFCI breaker has opened the circuit.
3. To restore power move handle A to “OFF” and then to “ON”.

If the device remains on when the Test button is pushed, the GFCI is not working properly or has been incorrectly installed (wired improperly). If your GFCI is not working properly, call a qualified, certified electrician who can assess the situation, rewire the GFCI if necessary, or replace the unit.

NOTE

All GFCI breakers implement an auto self-test function, however, Airstream recommends a manual test be conducted every month.

Entertainment Systems

TV and Sound System



 Your Airstream has Bluetooth® enabled Smart TVs and a Fusion® Apollo™ Stereo with LCD color touchscreen display, Bluetooth®, advanced SiriusXM features, FM radio, AUX, and USB connectivity.

The Fusion-Link Remote Control App can be used to control stereo functions. To download the app, scan the QR code above, search for Fusion-Link on your device's app store, or click on one of the following icons:



This versatile entertainment system allows you to connect devices for a personalized entertainment experience. The setup lets you play TV audio through the sound system or pair any TV with Bluetooth-enabled headphones or a portable speaker.

The following sections provide basic instructions for connecting devices, which are subject to change with new product developments and improvements. Please refer to the TV and stereo manuals in your owner's packet for additional details. Some TV's also have manuals available through the on-screen menu.

TV and Audio Component Pairing

To pair the desired Bluetooth audio component (stereo/headphones/portable speaker) with your Airstream's TV, place the audio component into pairing/discoverable mode. Then, enter the TV's settings menu and follow the prompts to select the desired Bluetooth device from the device list. Only one TV at a time can be played through the stereo via Bluetooth.

Smartphone and Stereo Pairing

Most smartphones can be paired with a stereo to stream music. Place the stereo into pairing/discoverable mode, enable Bluetooth on your smartphone, scan for nearby devices, and select the stereo.

USB Stereo Connection

To connect most smartphones and other digital media devices directly to the stereo, plug your device's USB cable into the USB port inside the media roof locker. Once connected, change the stereo's source from its current setting to USB.

Blu-ray/DVD Player and Streaming Device Connection

Blu-ray/DVD players and streaming devices can be connected to the TV using the *Bring Your Own Device* HDMI/Ethernet wall port (located in the media roof locker). Devices can be powered using the outlet next to the HDMI/Ethernet wall port or by plugging them into the nearby USB port. Streaming devices require internet access.

TV/Radio Antenna



The roof-mounted TV/Radio antenna receives free Local VHF/UHF TV signals and FM radio signals. The signal is boosted to maximize signal strength and provide TV and radio reception. The booster must be turned on to receive Local VHF/UHF TV signals and FM radio signals.

The antenna booster is controlled by a switch on the antenna booster's wall plate inside the media roof locker. Press the small pushbutton on the wall plate to turn **ON** the booster. To view cable or satellite, you will need to turn it **OFF**.

The antenna is constructed of durable automotive-grade plastic that is UV-protected, weatherproof, and capable of withstanding outdoor climates. Clean the antenna with mild soap and water only. Do not powerwash or use harsh cleaning solutions, solvents, or alcohol to clean the antenna or antenna base.

Cable/Satellite Connection

External Hookup:

You can establish a cable TV or satellite connection by attaching a cable TV service provider's coax cable, or a satellite coax cable, to the external roadside SmartPlug cable/satellite and ethernet inlet; [see SmartPlug Cable/Satellite and Ethernet Inlet on page 6-6](#).

Viewing Cable:

To view cable you will need to turn **OFF** the antenna booster by pressing the small round pushbutton on the antenna booster's wall plate (located in the media roof locker). To return to viewing a boosted antenna signal, press the button **ON**.

Connecting and Viewing Satellite:

Follow the steps below to connect a satellite receiver and view satellite TV. Before you begin, turn **OFF** the battery disconnect switch.

1. Locate the antenna booster's wall plate (inside the media roof locker), and remove the two mounting screws to access the backside of the wall plate.
2. Remove the cable from the cable jack (marked CABLE), reroute it out through the opening in the roof locker, and connect it to the input of the satellite receiver.
3. Run a coax cable (user supplied) from the satellite receiver output through the same hole and connect it to the cable jack.
4. Remount the booster plate and plug the satellite receiver power cord into the nearby outlet.
5. Turn **ON** the battery disconnect. Ensure the booster is off. If not, press the small pushbutton on the antenna booster's wall plate to turn it **OFF**.

Smart RV Control Technology

Smart RV

 Airstream Smart RV Control Technology provides the comfort and connectivity you need with the control you want. The multiplex network system communicates (via the onboard router) with the Airstream Smart RV Control app to allow resource monitoring and control of vital features of your Airstream while onboard or away on an adventure. The mobile app provides quick access to your owner's manual, checklists, and customer support contacts. The GPS feature lets you easily find your way back to camp should you take a wrong turn. The Smart RV Control system can also be used to update the multiplex system and aid technicians with troubleshooting.

For more information about Airstream Smart RV Control Technology, scan the QR code above, click the app icon below, or visit <https://www.airstream.com/smart-rv/> and view the Getting Started guide. Download the Airstream Smart RV Control app from the link above, or click on one of the following icons:



Connected RV

Router

Your Airstream includes a dual band (2.4GHz/5GHz) router which allows you to easily connect to the internet via either a cellular subscription or with access to an external wireless connection. The Connected system can provide a Wi-Fi hot spot for multiple devices including a separate login for guests (Retail cellular plans sold separately. Data and connection charges may apply). The router is located in the front roof locker. The key in the locker near the router disconnects power to the router and 24-hour network, including the fan controls and battery disconnect switch. This can be used to conserve power while boondocking when away from the unit, when in storage, or to reboot the router.

As part of the pairing process, your device will display the Wireless Network Name (SSID) and password for your wireless/cellular hotspot router. This creates

a secure password protected connection. Use this name and password to connect other devices to your Airstream's Wi-Fi network. You can find this information and FAQ's in the "more" tab of the mobile app.

Antenna

The High-gain multi-band antenna in conjunction with the router can boost an external Wi-Fi signal or connect to a cellular connection. It also allows for basic GPS location services through the app.

Ethernet Connection

You can establish an internet connection by attaching a service provider's ethernet cable to the external roadside SmartPlug cable/satellite and ethernet inlet; see [SmartPlug Cable/Satellite and Ethernet Inlet on page 6-6](#). The inlet is routed to the *Bring Your Own Device* HDMI/Ethernet wall port (located in the media roof locker). A modem and Wi-Fi router can be connected to the wall port via ethernet and powered by the nearby outlet.

Connecting to the Smart RV Control App

1. Download the Airstream Smart Control app.
2. Create a user account. Only one account can be paired to your Airstream at a time, however, you may use multiple devices with the same account.
3. Confirm the Wi-Fi key switch is turned "on" next to the router in the front overhead cabinet.
4. Follow the pairing process in the app to connect to your Airstream. The sticker containing the QR code is located in the front overhead cabinet. Do not remove this label as you will need it to re-pair the trailer if necessary. You are now ready to begin your adventure.

NOTICE

Do not remove the QR label as it will be required to re-pair to the trailer if necessary or by service technicians for updates and diagnosis.

⚠ WARNING

Do not use Connected and Smart RV control services and functions when driving or when the RV is otherwise in motion. Serious damage to the RV or property or serious injury to yourself or others may occur as such systems or functions may distract your attention from the road and/or may operate features of the RV which are intended for use only when in a stationary position.

NOTE

Airstream Smart RV Control products and services are intended for use in the United States only. Requires compatible device and Internet connection. Not all features available in all areas at all times. Additional data and connection charges may apply. See Terms of Service for important details.

NOTE

Depending on your service provider and data usage, roaming charges may occur.

NOTE

Using the key to turn off the system will disable the GPS function and other Smart RV Control services.

Privacy Disclaimer

Airstream Connected RV and Smart RV products and services (collectively, “Connected RV”) contain systems which may collect personal and other information from or about you, your devices, your RV (including its location, how and where it is used, and telematics data), and your Internet connection. We may also collect such information from applications, devices, and services you use in connection with your Connected RV.

We collect and process (including use, store, disclose, and share) personal information for a number of reasons, including providing assistance to you, troubleshooting, improving Airstream products, and to offer you products and services which may be of interest to you. Please read our Connected RV and Smart RV Terms of Service (www.Airstream.com/legal-notice) (“Terms of Service”) and our Privacy Policy (www.Airstream.com/privacy-policy) (“Privacy Policy”) for more specific information about the data we collect and process, our privacy practices, your rights, and important updates. Other parties may seek to access data independently of Airstream. Those parties are not subject to Airstream’s Terms of Service or Privacy Policy.

NOTE

Airstream Connected RV products and services are intended only for use in the United States.

Data and privacy protection laws where you use the Connected RV products and services may impose certain responsibilities on you with respect to your use of the products and services. You are responsible for

ensuring you comply with such laws when you use the products and services. You are responsible for informing those you permit to use or occupy your Connected RV (with or without you, and including anyone to whom you loan, give, or sell the Connected RV) how data related to their use of the RV may be collected and processed.

NOTICE

You may request to have automatic data transmission and collection disabled or limited by contacting Airstream Customer Service (see below). Note the functions and features of Connected products, systems, and services may be limited or may not work at all if you choose to prevent or limit the transmission, collection and processing of data and/or Airstream may terminate access to such functions and features in such an event.

You may request to have automatic data transmission and collection disabled or limited by contacting Airstream Customer Service. The functions and features of Connected RV products, systems, and services may be limited or may not work at all if you choose to prevent or limit the transmission, collection and processing of data and/or Airstream may terminate access to such functions and features in such an event.

Please contact Airstream Customer Service at 877-596-6111 or as provided in the Privacy Policy if you have questions or requests concerning Airstream Connected RV products, the collection and processing of data, or our privacy practices

NOTICE

Some data about your Connected Airstream (including telematics, usage, and location information) may be automatically transmitted to and collected by Airstream via an embedded basic cellular connection and/or a personal hotspot whenever your Connected Airstream has power. This functionality is on by default and might use a small amount of data from the associated plan. The transmission and collection of this data may occur whether or not you: enable, use, or cancel the Connected services; create or cancel an account; pair or unpair device; and whether or not your RV is parked or in motion.

Appliances

All appliances are delivered to Airstream Inc. with in-depth owner's manuals. Those manuals are included in the delivery case supplied by your dealer. The manuals may contain warnings, cautions, and operating instruction that should be read and followed before operating the appliances.

The information contained in the appliances manuals supersedes any information contained in the Airstream Trailer Owner's Manual on appliances. If you believe contradictory information on appliances is contained in this manual, or if any appliance manual(s) have not been provided with your trailer, contact your dealer, the respective appliance manufacturer, or Airstream Customer Service at 937-596-6111 or write:

Airstream Factory Service Center

428 W. Pike Street

P.O. Box 629

Jackson Center, OH 45334-0629

(937) 596-6111

⚠ WARNING

Airstream recommends shutting off the gas supply at the LPG tanks before refueling the tow vehicle or entering a refueling station.

Maintenance

Follow the instructions and warnings noted in the respective appliance and equipment owner's manuals, as well as those mentioned below.

Annual maintenance should be conducted on propane gas appliances and equipment by an authorized dealer or repair facility.

Insects can build nests in the burners of various appliances and equipment. The burner and burner orifice of the propane gas appliances and equipment should be cleaned by an authorized dealer or repair facility any time circumstances or conditions warrant, but no less than on an annual basis.

⚠ DANGER

Most LPG appliances used in recreational vehicles are vented to the outside of the vehicle. When parked close to a gasoline pump, it is possible that gasoline fumes could enter this type of appliance and ignite from the burner flame, CAUSING A FIRE OR AN EXPLOSION.

Air Conditioner

The roof A/C used on your Airstream has the lowest profile of any A/C on the market today. Coupled with an industry exclusive fiberglass basepan this lower profile and lighter weight means less drag and improved fuel efficiency. In your owner's packet is a set of literature covering all operating and maintenance instructions. If the literature is misplaced, contact the A/C manufacturer or your Airstream dealer for replacement.

Proper voltage to the air conditioner is critical. A voltmeter check may find voltage much lower at a campground shoreline outlet than the needed 110 to 120 volts. Low voltage is usually associated with older or poorly maintained trailer parks. Parking your trailer so the power cord can be plugged in to a receptacle close to the fuse or circuit breaker box can alleviate low voltage problems. Avoid extension cords and adapters whenever possible. If an extension cord must be used, it should be as short and heavy as possible to provide the most current.

If high temperatures are expected, make an effort to park in a shaded area. Starting the air conditioner early in the morning also helps. It is more efficient to hold a comfortable temperature than it is to lower the temperature after the interior of the trailer is already hot.

Never run your air conditioner with the vents closed. Doing so could cause the air conditioner to freeze and may damage to the unit. The manufacturer recommends having at least 3 AC vents open when running to prevent any chance of freezing up.

Air Conditioner Filters

The exterior sponge filter can be gently washed with soap and water as needed. The white pleated Merv 8 filter must be replaced. Replacement times will vary greatly depending on how often the air conditioner is used. With frequent use, the filter may last 3-4 months. With infrequent use, it may be possible to replace the filter annually. Contact your dealer or Airstream directly to obtain a replacement. For Airstream part numbers, [see Replacement Filters on page 8-4.](#)

⚠ WARNING

Review the air conditioning literature supplied in your owner's packet before proceeding.

Heat Pump

The air conditioners have a built in heat pump designed to take the chill out of the air. To operate, tap the Mode button to select “Heat” for the desired zone on the Multiplex panels climate control screen. The heat pump will run until the current temperature reaches the set temperature and then shut off.

NOTE

If operating on 30 amp service, running the heat pump and furnace on electric together could cause the breaker to trip. It is recommend to be connected to 50 amp service or to minimize the use of other appliances while running the heat pump.

Cooktop

There is little difference between the operation of home gas ranges and the trailer’s cooktop. If, however, you are used to an electric range, operating confidence can be quickly gained by reading the manufacturer’s directions provided in the owner’s packet. Manufacturer’s service and parts manuals are also available.

⚠ WARNING

An operation manual for the cooktop has been provided with your owner’s packet. If this has not been provided with your trailer, contact the listed manufacturer to obtain. Their manual contains specialized warnings and cautions that should be reviewed prior to operating the appliance.

Ceiling Vent Fan



The high-volume roof vent system is designed to quickly exhaust stale, hot air and draw in fresh air. It is great to use when the outside temperature does not call for air conditioning, but heat has built up in your trailer. The core of the system is a powerful rotary fan that works with a slightly open window to create a balanced airflow. It is designed for maximum air exchange, minimum sound levels and power consumption. Fresh, clean, natural air is pulled in. Hot, stale, stuffy air is pushed out.



The controls for the roof vent have been incorporated into the Multiplex System. The vent lid can be operated by pressing the Open/Close buttons in the climate control menu on the Multiplex control panel. Pressing the fan button once will turn the vent fan on low. Press the button a second and third time for medium or high. Pressing the button a fourth time will turn off the fan.

NOTE

For maximum airflow, do not close Vent Shade, if equipped, while using Exhaust Fan.

Thermostat and Rain Sensor

The fan is equipped with a built-in thermostat. Set the fan to auto and select your comfort setting on the Multiplex main touch control panel and the fan will automatically turn on and off as your trailer heats up and cools down. When the rain sensor becomes wet the dome will close automatically and shut the fan off. It will need to be manually restarted if the rain sensor shuts off the fan. If you are using the Airstream Smart RV Control app, you will get a notification if the rain sensor is activated.

Cleaning Instructions

⚠ WARNING

Never operate the fan with the screen removed and always disconnect power before cleaning or servicing. Review the vent fan manufacturer's cleaning instructions before cleaning or servicing the fan.

To clean the screen, turn the fan motor and battery disconnect switch OFF. The screen may be friction held or have retainer clips that need turned halfway to remove. Remove the screen and clean with a mild soap and water solution. Carefully pat dry with a soft cloth and reinstall.

NOTICE

The use of certain cleaners can cause cracking and product failure. Review the vent fan manufacturer's cleaning instructions before cleaning or servicing the fan.

If your vent fails to operate properly under normal conditions, please contact the manufacturer. Please have the retail sales date and the vent Serial Number readily available when you call. Refer to your operating guide for contact information.

Exhaust Vent



Operation

The bath exhaust vent (shown above) removes moisture from the air when using the shower. To operate, you first need to open the vent.

To open the vent, push the button on the handle to disengage the clip and slide the handle upward until the clip engages.

Once open, turn the fan on by pressing the ON/OFF button on the fan and/or by navigating to the Fan Control page on the Multiplex control panel and pressing ON.

Turn the fan off before closing the vent.

To close the vent, push the button on the handle to disengage the clip and pull the handle down until the clip engages in the lowered position.

NOTICE

Turn OFF the fan before closing the vent. Damage to the motor can occur if the fan runs with the vent closed.

Cleaning Instructions

⚠ WARNING

Never operate the fan with the screen removed and always disconnect power before cleaning or servicing. Review the vent fan manufacturer's cleaning instructions before cleaning or servicing the fan.

To clean the screen, turn the fan motor and battery disconnect switch OFF. Remove the four retainer screws. Clean the screen with a mild soap and water solution only.

Fuse

To change the 5 Amp fuse:

1. Make sure the fan is off.
2. Remove the cap by turning it to the left to gain access.
3. Replace with a type GMA 5A fast-acting fuse.
4. Replace the cap to secure the fuse in the holder.

Furnace

The manufacturer of the furnace in your trailer has been well known in the RV industry for many years. The furnace burns LP gas, and is powered by 12-volt current from the batteries or power converter when plugged in to city power.



The furnace is controlled from the Multiplex control panels Climate screen or Favorites page. Tap the furnace option and set the mode to "AUX". Use the up or down arrows to set the desired temperature. Tap the fan icons to select the desired fan speed.

Complete operating instructions are located in your owner's packet. If they should become misplaced, new literature can be ordered directly from the manufacturer or your Airstream dealer. The manufacturer also offers a detailed service guide for your furnace.

⚠ WARNING

Carefully read all the manufacturer's instructions prior to operating. NEVER store flammable material next to the furnace or in close proximity to the furnace exhaust outlet on the side of the trailer.

NOTICE

If warranty service is required, use only a service location recommended by the furnace manufacturer or your Airstream dealer.

Microwave Ovens

Refer to the Certified Performance Checkout sheet, included in your owner's packet, for manufacturer, model, and serial number information.

Monitor Panel



The monitor panel in the compartment under the rear dinette seat gathers data that is accessed and viewed on the Multiplex System display; [see Multiplex System on page 5-8](#). The monitor panel requires no input but remains functional and can be used should the need arise. Refer to the instructions that follow to operate the panel.

Tank levels are monitored by sender pads mounted on the sides of each tank. Data from each sender pad is transmitted to the display through a single two-conductor wire. When a button for a particular tank is pressed, the display powers up to show the current level. The display also indicates the battery voltage when the BATT button is pushed.

Viewing Tank Levels

Press and release the button corresponding to the tank to be checked, and the display will show the levels in percent on the LED display. If no other button is pressed, then the display shuts off after about 5 seconds.

If another button (including BATT) is pressed before the 5-second time is up for the first button, the display will immediately switch to show the new level or voltage. The 5-second time-out is restarted every time a button is pressed.

To continuously display a reading, press and release the desired button, then press the same button again. The display will be on hold mode when the button is released, indicated by the decimal point on the right-hand side. While the display is in hold mode, it will recheck the level once per second so the user can watch the level change while the tank is filled or drained. The display will automatically shut off after 5 minutes in hold mode. To end the hold mode before the 5 minutes is up, press any tank button, and the display will shut off. By pushing two buttons at once, the diagnostic functions can be accessed.

Viewing Battery Voltage

Press the BATT button and release it; the display will show the battery voltage on the LED display. The display will shut down after about 5 seconds if no other button is pressed.

If the BATT button is held down, the display continuously rechecks the voltage and shows the updated value. The reading may flicker back and forth between two values.

If another button is pressed before the 5-second time is up for the BATT button, the display will immediately switch to show the value for the new button. The 5-second time-out is restarted every time a button is pressed. There is no hold mode for the battery voltage.

Refrigerator

Review all refrigerator literature supplied in your owner's packet or stored in the refrigerator prior to operating it.

The refrigerator is all-electric and features a strong 12V compressor, no LPG is required. To turn the refrigerator on, touch and release the ON/OFF button. The blue indicator light will glow solid blue to indicate that the refrigerator is on. To get ready for a trip, start your refrigerator and let it cool for eight hours before loading with food. For the best cooling performance, let air move freely inside the compartments. The freezer and refrigerator compartments operate independently of each other. To shut down the refrigerator, touch and hold the ON/Off button for 5 seconds and release. During travel the door latch prevents the door from opening. Close the door toward the refrigerator until you hear a "click" sound to ensure the door is properly latched.

It will be necessary to defrost the refrigerator and freezer compartment from time to time. Frequency depends on usage, the number of times the door is opened and closed, and the humidity level. To defrost, turn the refrigerator off and prop open the door. Most of the condensation will run out of the condensate tube to the outside of the trailer. Use dry towels to keep extra condensation from dripping onto the floor. Do not use heat or sharp objects to speed up the defrosting process as this can damage the unit.

Clean the interior periodically with mild cleaner or solution of liquid dish detergent and warm water. Rinse with a solution of baking soda and clean water. To decrease the amount of ice that collects on the rear wall of the refrigerator freezer and fresh food, cover all liquids and moist food, let all hot foods cool before putting them in the refrigerator. Do not open the door any longer than necessary. The freezer compartment is made to keep pre-frozen food frozen and not to quick freeze food. Ensure the airflow vents are clear and clean for optimal operation.

NOTICE

Speeding up the defrost process with a knife or scraper is strongly discouraged due to the likelihood of rupturing the refrigerant circuit.

Solar System

The rooftop solar panels installed on your Airstream help maintain battery health, reduce operating expenses, and extend the battery life of the batteries. The solar system's solar charge controller gathers energy from the individual solar panels and stores it in your batteries. The solar charging information is displayed on the Multiplex touch panel and on the Airstream Smart RV Control app.

The Victron charge controller is configured for a three step charging process:

1. Bulk - The controller delivers as much charge current as possible to quickly recharge the batteries.
2. Absorption - The controller switches to a constant voltage mode.
3. Float - Voltage is applied to the batteries to maintain them in a fully charged state.

In addition to the factory-installed solar panels, a quick plug-in port suitable for a portable solar charging kit has been pre-wired at the front of the unit near the propane tanks. Portable solar panel kits MUST include a solar controller set to a Lithium profile and cannot have an output of more than 10 amps. The solar port is fused at 10 amps in a holder in the battery box. For solar wiring, [see 12-Volt Main Schematic on page 8-19](#) and [see Solar Panel Wiring on page 8-22](#).

Smart Shunt

The trailer is equipped with a Smart Shunt, used to determine the State Of Charge (SOC) of the batteries. SOC is a more accurate means of determining the percentage remaining of the lithium batteries, based on current usage. The Smart Shunt can be linked to the Airstream Smart RV Control app, which allows for the monitoring of the batteries from a connected device. The Airstream Smart RV Control app is available to download for both, Apple and Android devices.

Calibration

The system is calibrated at Airstream, however, if the batteries are disconnected or fully discharged, past the state of BMS protection, the Smart Shunt will need to be recalibrated. To do so, the batteries must be fully charged to a peak voltage of 14.3 volts. If the shunt is not calibrated correctly, the SOC status will appear dashed out.

NOTE

The converter has a maximum charge time of 4 hours, which may not be long enough to fully charge the batteries. To continue charging, disconnect the shoreline power supply and reconnect. This will allow the converter to continue charging for another 4 hours.

Water Heater



The trailer is equipped with a continuous water heater featuring freeze protection, and direct spark ignition. The tankless water heater monitors inlet water temperature and flow, and output water temperature and flow. The water heater is operated by the control panel located on the wall above the galley sink. Turn on the power and press the temperature selection arrow to see the current setting. Set the desired temperature using the up or down arrows.

Normally, the burner will ignite in just a few seconds unless your LPG system has not been used for some time and air has filled the lines. The system will go into safety lockout, after 3 failed ignition attempts, before the air is expelled. If this happens and error code of "E1" will appear on the screen. Turning the Water Heater off for 30 seconds and then back on reinstates the ignition mode.

Common Error Codes

- **E1:** Ignition failure of accidental flame off during ignition – Check that you have LP in the tanks, that other LP appliances work, and no debris or obstruction in the burner.
- **E2:** Flame sensing interrupted during normal operation, a buzzer will sound. Check that you have LP in the tanks, that other LP appliances work, and no debris or obstruction in the burner.
- **En:** System timer – System will shut off after 20 minutes of continuous usage
- **Fd:** Water heater operating in Winter Use – The water heater will run for a few seconds and then shut off in freezing conditions if the power is ON. This mode will only protect the Water Heater heat exchanger and not your Airstream's plumbing system.

⚠ WARNING

Review the water heater literature supplied in your owner's packet before proceeding.

NOTE

The water heater will not operate until a faucet is opened with a minimum water flow of .8 gallons per minute. This process could take up to 60 seconds to register.

⚠ WARNING

The water heater has built-in FREEZE PROTECTION and will intermittently cycle the burner when the water temperature reaches 3°C/ 38°F. To provide this freeze protection, the gas supply must be on, gas must be available and electrical power must be on.

⚠ WARNING

This appliance does not have a pilot. It is equipped with an ignition device which automatically lights the burner. Do not try to light the burner by hand.

⚠ WARNING

It is dangerous to operate a Tankless Water Heater Unattended. This may occur accidentally if a sufficient leak develops or if a faucet is left open. For this reason the GSWH-2 will automatically shut off after running for 20 minutes and the display will show Error "En".

AIRSTREAM®

Section 6 EXTERIOR

CLEANING	6-2	Hitch/Coupler	6-7
Exterior Skin	6-2	Axle and Running Gear Assembly	6-7
Windows	6-2	Nev-R-Lube Drums/Bearings	6-8
Aluminum Wheels	6-2	Power Stabilizing Jacks	6-8
GENERAL INFORMATION AND OPERATION	6-3	Power Jack	6-8
Step	6-3	Power Jack Blade-Style Circuit Breaker	6-8
Main Door	6-3	Manual Operation	6-8
Screen Door	6-3	Liquid Petroleum Gas (LPG)	6-9
Emergency Escape Windows	6-3	Fill Valve	6-9
Front End Protection	6-4	Automatic Gas Regulator	6-10
Window Stone Guards	6-4	LPG Tanks	6-10
Stainless Steel Rock Guards	6-4	Exterior LPG Port	6-11
Dining/Serving Ledge	6-4	Basic Rules For LPG Safety	6-11
Power Awning	6-4	If You Smell Gas	6-11
Gravity Water Fill	6-6		
City Water Hookup	6-6		
Exterior Shower	6-6		
120-Volt Outlet	6-6		
SmartPlug Cable/Satellite and Ethernet Inlet	6-6		
Shoreline Power Inlet and Cordset	6-7		
SmartPlug Inlet	6-7		
SmartPlug Cordset	6-7		

Cleaning

Exterior Skin

We recommend the trailer be washed about every four weeks, and waxed with Walbernize Super Seal or high quality clearcoat-safe wax in the spring and fall. In coastal and industrial areas, cleaning and waxing should be done more frequently. When traveling through winter weather, all road treatment chemicals should be removed immediately.

NOTICE

Abrasive polishes or cleaning solvents such as automatic dishwasher or acid etch cleaners are too strong and should never be used. Rinse all grit from surface prior to washing. Use soft rags or wash mitts, always moving lengthwise with the grain of the trailer (washing or polishing). Never rub hard on the coating. Even the softest rag will damage the coating if excessive pressure is applied.

NOTICE

Always clean your trailer in the shade or on a cloudy day when the aluminum skin is cool.

Oil, grease, dust, and dirt may be removed by washing skin with any mild non-abrasive soap or detergent. Cleaning should be followed by a thorough clean water rinse. Drying the unit with a chamois or a soft cloth may prevent spots and streaks.

After cleaning and drying, a good grade of non-abrasive automotive paste or liquid wax will increase the life of the finish, especially in coastal areas where the finish is exposed to salt air or in polluted industrial areas. It will also protect the shell from minor scratches and make subsequent cleaning easier.

It is important to remove substances such as sap, gum, resin, and asphalt as soon as possible by washing and waxing. Sunlight and time will bake-harden these materials, making them almost impossible to remove without heavy buffing. If asphalt remains on the trailer after washing, use a small amount of kerosene on a rag and wipe the spots individually, being careful not to scratch the finish.

If a substance is found on the coating that cannot be removed by normal washing procedures, Airstream recommends using DX 330 Acryli-Clean, made by PPG Industries. Follow all directions and warnings on the product container.

Acryli-Clean should be used by trained personnel only, using the proper equipment under controlled conditions. Use the Acryli-Clean as sparingly as possible to remove glue, tar, and other similar substance.

To keep your trailer looking new, periodically paint the A-frame, LPG tanks, and rear frame.

It is recommended that the caulking and sealant used in external seams and joints, such as end-shell segments and around window frames, light bezels, beltline, and rub rail molding, etc., be checked once a year. If this material has dried and become cracked or checked, or if a portion has fallen out, it should be replaced with fresh material to prevent possible rain leaks. Caulking and sealing products are available from your Airstream dealer.

Windows

Clean your trailer windows the same way you clean the windows in your home. Clean the seals with a damp cloth and mild detergent every three to six months. Do not use strong solvents, as they will damage the seals. A coat of natural silicone lubricant applied after the seal has dried will keep it flexible. Spread the lubricant evenly with a brush or finger, working it into the surface. This is a good practice for all rubber seals in your trailer.

⚠ WARNING

Failure to properly clean and lubricate the window seals could result in the window sticking to the jamb. Window seals that become stuck to the window jamb should be released by a qualified technician trained in the procedure. Do not force, pry, or apply great pressure to open the window. Failure to heed this warning may cause the window to shatter and/or cause personal injury.

For replacement of a damaged window, contact an Airstream Service Center.

Aluminum Wheels

The aluminum wheels and axle end cover come treated with a clear coating. Keep them looking good by washing with soap and water. Do not use abrasive cleaners or polishes on coated aluminum wheels.

General Information and Operation

Step



To operate the step, lift up on the front of the step and pull straight out until step locks into place. After extending step, the second portion folds out. To store the step, fold it back into position, lift the front slightly, and push the step back into its storage area.

⚠ WARNING

Never enter the trailer without lowering the steps. Always check that the steps are down before stepping out of the trailer. Once the steps are lowered, press down on them to make sure they are secure in their notches. Never travel with step lowered or extended.

Main Door



The orientation of the latch assembly shown above may be inverted on your trailer, depending on the direction the door opens.

⚠ WARNING

BEFORE TOWING

The door handle and deadbolt must both be locked from the exterior using the keys. Never lock them before shutting the door. Failure to fully lock both the handle and deadbolt using the keys in the manner described as follows may result in the door vibrating open during travel.

Close and lock the door from the exterior using the keys in the following order:

1. **DOOR HANDLE:** Insert the **ROUND KEY** and rotate it counterclockwise until it stops and an audible **CLICK** is heard; rotate the key back approximately 1/4-turn to the vertical position to remove it.
2. **DEADBOLT:** Insert the **SQUARE KEY** and rotate it counterclockwise until it stops and an audible **CLICK** is heard; rotate the key back approximately 1/4-turn to the vertical position to remove it.

Pull on the handle to verify the door is secured.

⚠ WARNING

Never transport passengers inside a trailer. Towing a trailer with passengers inside is unsafe and could result in death or serious injury.

NOTICE

To avoid damaging the door jamb and latch assembly, ensure the deadbolt is retracted before closing the door.

The main door has a hold-back that secures it to the side of the trailer when the screen door is in use. To use the hold-back, gently push the door into the spring-operated slide to latch it; slide the hold-back to release.

For lubrication and out-of-adjustment issues, see [Main Door Care](#) on page 8-18.

Screen Door

The screen door is secured to the main door by a slide bolt-type latch. It can be operated independently by releasing the slide bolt and swinging the screen door away from the main door.

NOTICE

Always reattach the screen door to the main door prior to closing the main door; otherwise, damage may occur.

Emergency Escape Windows

To remove the screen, pull out the screen cord by the cord loop at the bottom portion of the window. Turn the two red latches inward and lift the two red arms on each side, in unison, to open the window and push it out for clearance.

Front End Protection



Window Stone Guards

The tinted solar plexiglass window stone guards on the front of your Airstream provide added protection from road debris while traveling and reduce the effects of sun rays.

Raise the center window guard to allow air to flow when the window is open. To raise, unhook the two rubber T-handles on the bottom of the guard, lift the guard to the desired height, and tighten the thumbscrews on each support arm. Be sure to lower and fasten the guard when high winds are approaching and before travel.

The corner window guards are removable for cleaning. Airstream recommends removing the corner guards from the unit when cleaning to avoid damaging the guards. There are two screws on each corner guard near the center guard. A quarter-turn will loosen the screws, and the guards will swing outward on their hinges. Lift the guards off the hinges to remove them.

NOTICE

Close window guards before high winds and storm conditions approach, or when towing to avoid damage to the trailer and window guards that cannot be covered by warranty.

Stainless Steel Rock Guards



Stainless steel rock guards protect the front end from road debris. You can clean behind the rock guards by swinging them forward on their hinges. They are locked in place with two acorn-style nuts, removable with a 7/16" wrench.

Dining/Serving Ledge



Your Airstream will come uniquely equipped with a serving ledge, perfect for entertaining guests. The ledge is designed to hang over the curbside window frame and provides an outdoor food and beverage stand. When not in use, the ledge can be stored in the rear exterior storage compartment.

Power Awning

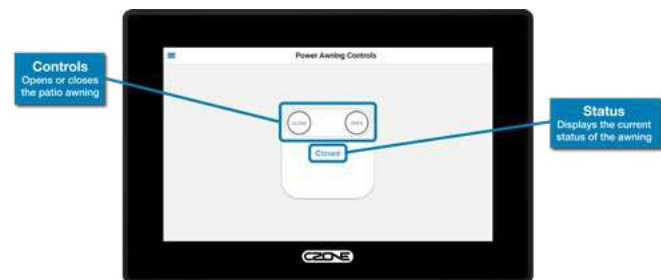

The awning's primary function is sun protection. It is not water proof, therefore, roll up your awning in case of heavy rain, wind, or snow. Complete operating instructions have been provided with your power awning. Make sure your traveling companion is familiar with the operation of the awning.

The Awning Menu provides power awning controls to OPEN and CLOSE the awning. The status display will change while the awning is in motion. The awning can be stopped at any point for partial extension by tapping the icon a second time. LED light strips have been installed with your awning providing accent lighting. The LED lights are operated by the main Multiplex control panel or the Exterior light Master on the panel located at the entry door.

Once the awning has been fully OPENED tilt icons will be displayed. Tapping the icons will tilt the awning towards the front OR rear of the travel trailer. The status display will change to read the current tilt. The awning can not be tilted in both directions at the same time.

The power awning will automatically lock if the travel trailer is plugged into a tow vehicle through the 7-way plug, and the tow vehicle's brake pedal is pressed. The touch screen's awning status will display "locked." To unlock, press and hold together the tilt front and tilt rear buttons located on the entry door switch panel.

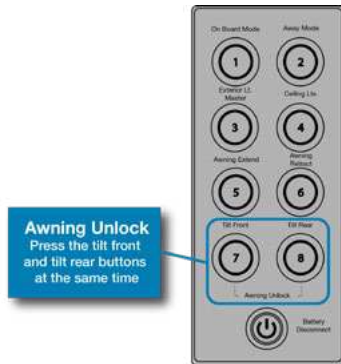

Clear tape is placed between the exterior skin and the awning fabric to prevent the awning fabric from rubbing on the coating, thus wearing through it. Inspect the tape every year or after a long trip. Have it replaced if it begins to wear thin.

The power awning is controlled by either the switch panel located inside the main door or the main Multiplex control panel. You can also control the awning through the Airstream Smart RV Control app. You will get a pop up to confirm when using the app to ensure you are intending for the awning to deploy. Make sure that there is nothing that can impede the deployment of the awning.

NOTICE

The effects of wind and rain on any awning are unpredictable. If wind or extended periods of rain are expected, roll up the awning and secure in traveling position. Severe damage to the trailer and/or the awning may result and cannot be covered by warranty.

NOTICE

Ensure that there is nothing impeding the deployment of the awning when using the app away from the trailer.

If the power to the awning has been turned off or interrupted, the entry door must be closed before retracting the awning. When power is interrupted, the awning controller must reestablish its "home" position by completing a "closed/reset cycle." This is a normal procedure whenever power to the awning controller is interrupted.

During the close/reset cycle, the awning arms will fully lower before the awning retracts. If the main entry door is left open during this process, the awning's gas rafter will contact the door, damaging the gas rafter. If you turn off the power to the awning, or if power is lost while it is extended, follow these steps to retract it:

1. Unlock the awning by simultaneously pressing the Tilt Front and Tilt Rear buttons.
2. Close the entry door, press the retract/close button, and wait for the awning to come to a complete stop. The close/reset cycle is a timed process that prohibits the awning from completely closing, protecting it from damage.
3. Press the extend/open button and when the awning starts to extend, press the retract/close button once to stop the awning.
4. To complete the process, press the retract/close button once again to finish retracting the awning. After the awning has finished closing, the screen should read "Closed." The home position has been restored.

NOTICE

To avoid damaging the entry door, awning, and awning gas rafter after power to the awning has been interrupted, ensure the door is closed before retracting the awning.

Exterior

Gravity Water Fill

The gravity water fill is located on the side of the trailer, behind a locked compartment. It is used to fill the fresh water tank with potable water. A small vent is located next to the port to allow air to expel from the tank as it is filled.

Fill the water tank by inserting a high-pressure RV/ Marine FDA approved drinking water hose of at least ½-in. diameter made from material that is tasteless, odorless, and non-toxic. It's a good idea to let the water run through the hose for a short time to flush it out. RVers sometimes fill their tanks with "home" water to avoid strange water that may be distasteful to them on short outings. Remember, the more water you carry in the fresh water tank, the less cargo carrying capacity you have for other items. The amount of water in the tank may be checked on the Multiplex Control Panel.

City Water Hookup



The city water hook-up is located on the side of the trailer. For consistent water flow and plumbing line safety, an in-line regulator limits pressure to 50 psi.

Use a tasteless, odorless, and non-toxic high-pressure hose of at least 1/2 in. diameter designed for RV use. The city water inlet is a standard garden hose thread. We suggest you carry two lengths of hose in order to reach hookups farther away than normal, plus, to have a spare.

After hooking up the hose and turning on the city water valve provided in the park, slowly open a faucet. There will be a lot of spurts and sputtering until all the air is expelled from the trailer system. If the water heater is empty, it will take some time before all the air is expelled and a steady flow of water occurs at the faucet. Once a steady flow is achieved at one faucet, the others should be opened long enough to expel the air in the lines going to them.

Your plumbing system has a built-in pressure regulator to protect your lines and faucets from extremely high pressures on some city water systems.

Exterior Shower



The Airstream is equipped with an exterior shower. This shower consists of a shower hose, shower head, and water valve inside of a lockable exterior door. Water is supplied by the pump or city water hookup.

120-Volt Outlet

A 120 volt receptacle is located on the curbside of the travel trailer and is labeled for your convenience. The trailer must be plugged into a shoreline power supply for the outlet to operate.

SmartPlug Cable/Satellite and Ethernet Inlet



Connect any external cable TV provider's coax or portable satellite antenna coax and ethernet internet cable to the SmartPlug Cable/Satellite and Ethernet Inlet (located on the roadside exterior near the Smartplug power inlet).

Shoreline Power Inlet and Cordset



SmartPlug Inlet

Your Airstream is equipped with a SmartPlug power inlet located on the roadside exterior. Prior to establishing a connection, review the SmartPlug Cordset instructions that follow.

Features of the SmartPlug include:

- Eliminates Overheating - Increased pin & clip surface area improves conductivity during high demand.
- Ease of Use - The unique plug body shape and push-in design ensure a proper connection.
- Multi-Point Locking System - Side clips lock the plug securely into the inlet, eliminating stress on the pins.
- Weatherproof Seals - Multi-fin silicone gaskets installed in the inlet cover and interior of the plug body eliminate moisture penetration.

SmartPlug Cordset

Before connecting power to your Airstream, plug the cordset (power cord) into the power pedestal and check the cordset's safe/unsafe LED indicator lights. If the red LED illuminates, do not plug the cordset into the SmartPlug inlet on your Airstream.

The cordset has a Reverse Polarity Indicator System with two LED indicator lights, one blue and one red. Reverse polarity occurs when connecting a cordset to a power pedestal that has the positive and negative leads reversed internally. A reverse polarity condition is unsafe, and it can damage an Airstream's electrical components.

Safe/Unsafe LED Signals:

- Blue ON, Red OFF - Normal Power, Safe
- Blue ON, Red ON - L1 and neutral are swapped in a reverse polarity condition, Unsafe
- Blue OFF, Red ON - L1 and ground are swapped in a dangerous reverse polarity condition, Unsafe
- Blue OFF, Red OFF - No Power

Many campgrounds provide less than 30 amp service, and your hookup may blow their fuse or circuit breaker. If this happens, reduce the load, replace the fuse, or reset the breaker.

⚠ WARNING

A reverse polarity condition is detected if the cordset's LED illuminates RED when connected to a power source. If this occurs, do not plug the cord into your Airstream. Reverse polarity is an UNSAFE condition that could result in bodily harm. It can also damage electrical components. This condition exists when the power pedestal is improperly wired.

Hitch/Coupler

The EZ-Latch coupler features a simple-to-use latching mechanism. Hooking up is as easy as dropping the coupler on to your hitch ball. Simply make sure that the coupler is properly lined up with the ball, then lower the coupler. The coupler will automatically open and latch into place when lowered onto the hitch ball. To disengage coupler, pull up on latch and raise coupler off of hitch ball. Return the coupler latch to the latched position to ensure that coupler is ready to be latched again. The coupler features a strong composite handle, If the handle does get damaged or becomes missing, the coupler is still completely operational until the handle can be replaced. Replacement parts can be purchased through your Airstream Dealer. See additional information included in your owner's packet.

Axle and Running Gear Assembly

Each Dexter Torflex® rubber torsion axle is aligned during manufacturing, and double-checked on a random basis. Alignment after delivery is the customer's responsibility.

Hitting chuck holes or rough railroad tracks while traveling straight will only cause misalignment after the tire has struck such objects many times. Of course, a deep enough hole can affect the alignment immediately.

The worst culprit is a curb because they are normally struck at an angle. Rear axles are occasionally damaged when people are attempting to park beside a curb while backing up their trailer.

The trailer axle(s) is bent upward in the middle. This bend is normal and is how the camber is obtained. Also, toe-in is built into the axle by very slight bends in the axle tube on each end.

Tire wear indicates misalignment. Check with your dealer for the nearest location with the proper equipment to correct the trailer's alignment.

For Toe-In and Camber Specifications, see [Toe-In and Camber Specifications on page 8-10](#).

Nev-R-Lube Drums/Bearings

Dexter's Nev-R-Lube bearings are comprised of opposed tapered roller bearing cones sealed inside a precision-ground, one-piece, double-cup arrangement. These bearings are designed with a small amount of axial end-play. The end-play is essential to the longevity of the bearing's service life; see [Nev-R-Lube Bearing Inspection on page 8-10](#).

Power Stabilizing Jacks

The trailer is equipped with two sets of power stabilizing jacks (front and rear). These jacks are controlled by a switch located in the locked compartment on the side of the trailer.

NOTE

Power stabilizing jacks automatically adjust to the terrain and should only be lowered until they make contact with the ground.

CAUTION

Stabilizing jacks are designed to stabilize the trailer only. Misuse of the power jacks to level or lift the trailer will result in damage to the jacks and potentially the trailer.

Power Jack

The power jack is operated using the up/down switch on the power head. When the jack is fully extended or retracted, the internal clutch will activate.

- Use the jack for lifting the trailer only.
- Never get beneath the travel trailer when only the power jack supports it.
- Support the vehicle by appropriate means.

WARNING

Avoid the risk of injury to yourself and others. Keep hands and feet from under the foot plate when using the jack. Do not use or install dolly wheels on the power jack. Do not operate the toggle switch with the manual crank handle in place. Failure to comply could result in serious injury.

NOTE

When operating the power jack, pause briefly between switching up and down. Rapidly switching from up or down may cause the breaker to trip, momentarily interrupting power to the jack.

Power Jack Blade-Style Circuit Breaker



The jack is wired directly to the battery and has an automatically resetting blade-style circuit breaker between the battery and the power head inside the battery box. Should the breaker trip, allow time for it to reset and try operating the jack again. If the breaker does not reset or trips again, the jack may need to be serviced, or the breaker may need to be replaced. Refer to an authorized dealer for service. For maintenance information, see [Power Jack on page 6-8](#). For breaker replacement, see [Replacement Breakers - USA Breakers on page 8-3](#).

Manual Operation

Should an electrical failure occur, the jack can be operated manually by unscrewing the bubble level/cap and placing the manual override handle into the alignment tube to engage the drive pin. Rotate the handle counterclockwise to raise or clockwise to lower the trailer.

Liquid Petroleum Gas (LPG)

Fill Valve



The LPG tanks are equipped with fill valve connections **RV Type I Acme**. The large, green, nylon swivel nut is a right-hand thread and is designed for hand operation only.

The valve features an internal spring-loaded module that will not allow gas to flow from the cylinder until a positive seal has been made at the connection. The valve outlet has 1-5/16 in. Acme threads on the outlet exterior, and female POL fitting; left-handed threads on its interior. This feature allows for connection of the new, wrench less, right-handed, Acme RV connection while still accommodating the standard left-handed POL fittings used for filling propane cylinders.

The mating, green swivel nut and brass nipple also incorporate new features: the green nylon nut swivels on a black bushing that is heat-sensitive. Between 240 and 300°F, the bushing will yield (melt) allowing the spring-loaded module in the valve to push the brass nipple back (approximately 1/4 in.), closing the module and stopping the flow of gas from the cylinder. Inside the brass nipple is a flow-limiting device designed to sense excessive gas flow. If an excessive flow is sensed, the flow-limiting device shuts the flow down to a maximum of 10 SCFH (Standard Cubic Feet per Hour) or less. This is also referred to as the bypass flow.

Bypass flow is extremely important in the proper operation of this connection. The flow-limiting device may activate if the cylinder valve is opened quickly. When all appliances are off, the bypass flow allows the pressure downstream from the flow-limiting device to equalize. When pressure is equalized, the flow-limiting device will supply normal flow to the system. Equalization occurs in approximately 5 seconds and, in most cases, goes completely unnoticed. If, however, an appliance is left on or there is a leak or open flow in the system, the bypass pressure will not be able to equalize and allow the flow-limiting device to re-open.

Symptoms of this condition would be appliances that light but have lower than normal flame or starve out from lack of gas, a substantial reduction in the flame when another appliance is operating, or pilots that are difficult to light. If this should happen, the following steps should eliminate the condition:

1. Close LPG cylinder valve.*
2. Extinguish all flames and smoking materials.
3. Be sure all gas appliances, including their pilot lights, are off.*
4. Open LPG cylinder valve slowly. Do not snap open.
5. Wait at least 15 seconds before lighting appliances.
6. If operational difficulties continue, there may be a leak in the system. Immediately close the LPG cylinder valve and have the system inspected by a qualified RV service technician.

*When reconnecting a full cylinder to an auto changeover regulator, it is not necessary to shut off the appliances or close the valve of the cylinder already in service.

The amount of time a full tank of gas will last is dependent on usage. In cold weather, when you are using the furnace, large amounts of hot water, and are doing extensive cooking, you will naturally use more than you will in warm weather when you may do limited cooking. On the average, with normal cooking and other appliance use, you can probably count on two to three weeks of service from each tank.

⚠ DANGER

Leaking LPG may ignite, causing a fire or explosion, which could result in serious bodily injury, property damage, and/or death.

Automatic Gas Regulator



All models are equipped with a two stage automatic change-over gas regulator that offers the convenience of automatic changeover from empty to full gas cylinders. Both tanks are connected to this regulator.

Make sure there is propane in both tanks before you start. Rotate the white knob on the top-front side of the regulator toward the cylinder you want to use first. This will be the **service** cylinder and the other will be the **reserve** cylinder. Slowly open both cylinder valves. Open both cylinder valves completely, then close about 1/4-turn. This will allow you to easily check to see if valves are open or closed. The indicator on top of the regulator will turn bright green. The indicator will stay bright green as long as there is fuel coming from the service cylinder. When the service cylinder empties, the regulator will automatically draw fuel from the reserve cylinder, providing an uninterrupted fuel flow to the system. When it switches over, the indicator will change from green to red. This red color indicates the service cylinder is empty and needs to be filled.

⚠ DANGER

LPG regulators must always be installed with the diaphragm vent facing down. Regulators that are not located in compartments have been equipped with a protective cover. Make sure the regulator vent faces down and the cover is kept in place to minimize vent blockage, which could result in excessive gas pressure, causing fire or explosion.

LPG Tanks

The following procedure outlines the proper method of removing and installing LPG bottles:

1. Turn the knob on your automatic regulator until the arrow points to the tank opposite the one to be removed. Shut off the gas valve on the tank to be removed.
2. Disconnect the rubber gas line at the tank to be removed (the green plastic fitting is a right-hand thread and no tools should be used).
3. Turn the large clamping T-handle counterclockwise until the hold-down bracket is loosened enough to be able to remove the tank. If your trailer is equipped with a gas tank cover, the T-handle must be removed, and then the cover removed before removing the bottle

⚠ WARNING

Do not remove the center hold-down rod.

LPG Tank Installation:

1. Place the tanks in position on the A-frame and tank cross-member so that it rests on the upper collar of both tanks with the collar rims engaged in the grooves on the underside of the bracket. If your trailer is equipped with a tank cover, it should be positioned over the tanks next. Make sure the hold-down rod projects up through the hole in the shroud center bracket.
2. Replace the T-handle and tighten down until the tanks are held firmly in place.
3. Test fittings with liquid soap free of ammonia or chlorine, or products designed for testing, such as Snoop® liquid leak detector.

If you have allowed both tanks to run out, air may have gotten into the lines. In this event, the air must be forced out through the lines by gas pressure before you will be able to light the pilots. Hold a match to the pilot of the appliance closest to the tanks until it lights and stays lit. Then move to the next-closest appliance, etc.

⚠ WARNING

Your LPG tanks must be filled as directed by the tank manufacturer. Instructions are located on a decal near the fill valve. The decal must not be defaced.

⚠ WARNING

The LPG tanks are securely mounted on the front A-frame of your trailer. If these tanks must be removed for service or replacement, it is important that they be reinstalled correctly in order to prevent any possibility of their falling off or becoming dislodged during travel.

⚠ WARNING

Use only the LPG tanks furnished with your trailer. If replacement is required, it must be a bottle of the same size and design.

Exterior LPG Port

An exterior LPG port quick-connect is installed on the hitch A-frame of your trailer. An LPG supply line is shipped with the trailer in the loose parts box. This can be used to connect a lantern or other appliance that uses a one-pound, low pressure LPG tank supply to the exterior port.

To assemble, install a male quick-connect coupler to one end of the supply hose. Then add a flare fitting to the other end of the supply hose and install a one-pound tank coupler to the flare fitting. This assembly can be installed into the appliance in place of the one pound LPG tank.

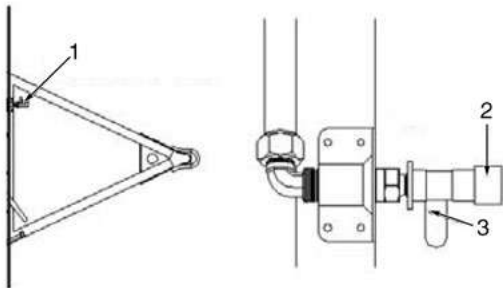

1. Exterior LPG Port
2. Quick-Connect Sleeve
3. Shutoff Lever

Basic Rules For LPG Safety

A warning label is displayed in the cooking area reminding you to provide an adequate supply of fresh air for combustion. The amount of oxygen supply in a trailer is limited due to its compact design. When using the cooking appliances, proper ventilation will prevent dangers of asphyxiation. It is especially important that cooking appliances not be used for comfort heating as the danger of asphyxiation is greater when the appliance is used for long periods of time.

⚠ DANGER

Do not use cooking appliances for comfort heating. Cooking appliances need fresh air for safe operation. Before operation, open an overhead vent or turn on an exhaust fan and open a window.

⚠ DANGER

A warning label has been located near the LPG container. This label reads: DO NOT FILL CONTAINER(S) TO MORE THAN 80 PERCENT OF CAPACITY. Overfilling the LPG container can result in uncontrolled gas flow, which can cause fire or explosion. A properly filled container will contain approximately 80 percent of its volume as LPG.

⚠ DANGER

Do not store LPG tanks within a vehicle. LPG tanks are equipped with safety devices that vent gas should the pressure become excessive.

⚠ DANGER

Portable fuel burning equipment, including wood and charcoal grills and stoves, shall not be used inside the recreational vehicle. The use of this equipment inside the recreational vehicle may cause fires or asphyxiation.

⚠ DANGER

Do not bring or store LPG tanks, gasoline, or other flammable liquids inside the vehicle because a fire or explosion may result.

Twice a year, or after a long storage period, we suggest you take your unit in for a checkup and cleaning of the gas-operated appliances.

If You Smell Gas

1. Extinguish any open flames, pilot lights, and all smoking materials.
2. Do not touch electrical switches.
3. Shut off the gas supply at the tank valve(s) or gas supply connection.
4. Open doors and other ventilating openings.
5. Leave the area until odor clears.
6. Have the gas system checked and leakage source corrected before using again.

AIRSTREAM®

Section 7 TOWING

TOW VEHICLE	7-2	TOWING	7-5
BRAKES	7-2	Safety	7-5
Electronic Brake Controller	7-2	Securing the Door.	7-5
Proper Electric Brake Use.	7-2	Practice.	7-5
Breakaway Switch.	7-3	General Information	7-6
LOADING	7-3	Tracking Observation	7-6
Weighing Your Trailer	7-4	Cooling System Overload.	7-6
HITCHING UP.	7-4	Downhill and Non-level Driving.	7-6
7-Way Plug	7-5	Off-Road Towing	7-7
Equalizing Hitch Load Distribution	7-5	When Being Passed	7-7
Wireless Observation System	7-5	Passing	7-7
		Backing Up	7-7
		Stopped On a Hill	7-7
		Controlling Sway or Fishtailing	7-8
		Equipment	7-8
		Tongue weight	7-8
		Driving	7-8
		Corrective Measures	7-8
		Sway Control Device	7-8

Tow Vehicle

When buying a new vehicle to tow your trailer, we suggest including towing options offered by most tow vehicle manufacturers. These include such things as a heavy-duty alternator and radiator, heavy-duty springs and shock absorbers, transmission cooler, heavy-duty fan and flasher unit, etc., for the make of the vehicle.

⚠ WARNING

Springs that are too stiff can hinder the action of the weight equalizing hitch and prevent the transfer of weight to the front of the vehicle.

NOTICE

Only use springs heavy enough to support your loaded vehicle (not including trailer). Having a too harsh spring rate on your tow vehicle will only shorten the life of the tow vehicle and trailer, and will cause your trips to be less enjoyable.

Transmissions may be manual or automatic, but an automatic transmission may prolong your tow vehicle's life and generally does a better job of controlling engine loads than does the average driver using a manual shift.

Having adequate power is very important when considering the purchase of a new vehicle or the trailer-towing capability of your present one. Auto dealers are provided with guidelines to use when helping a customer decide on a tow vehicle. Guidelines are not determined solely by the power output of the engine. The gear ratio of the differential is also a very important part of the guideline.

Inspect the tow vehicle's hitch regularly for loose bolts or nuts, cracked welds, loose ball mounts, worn parts, etc.

New trailerists often carry more food and other supplies than really needed. Remember that every item you take along is one more thing to stow and adds weight to the total load you must pull. Consolidate items in shelves, lockers, and in the refrigerator. It is better to have one full and one empty locker, than two half empty ones. Special care must be taken not to overload the front and rear ends of the trailer.

Brakes

All trailers are equipped with Dexter Nev-R-Adjust brakes. Please follow all maintenance procedures in the Dexter user's manual provided in the owner's packet. For important inspection and maintenance requirements of the components discussed in this section, [see Axles and Brakes on page 8-10](#)

Electronic Brake Controller

The trailer brakes are operated by 12-volt current from your tow vehicle and must be hooked up so that you have an integral system with your tow vehicle brakes. To prevent problems and ensure satisfactory braking action, install an electronic controller in line with the brakes in your tow vehicle.

An electronic controller will synchronize the trailer brakes with your tow vehicle brakes. It is designed to apply the trailer brakes with your tow vehicle brakes. Your brake controller should be adjusted to provide for a slight lead of the trailer brakes over the tow vehicle brakes.

⚠ WARNING

Study all material provided with your particular brake control. If you do not understand the information, have the installer explain the information to you or call the manufacturer of the controller.

Proper Electric Brake Use

Proper synchronization of tow vehicle to trailer braking can only be accomplished by road testing. Brake lockup, grab, or harshness is quite often due to lack of synchronization between the tow vehicle and the trailer being towed, a too-high threshold voltage (over 2 volts), or under-adjusted brakes.

⚠ WARNING

Never use your tow vehicle or trailer brakes alone to stop the combined load.

⚠ WARNING

The braking system should be checked and serviced by qualified, certified technicians only. Failure to do so could result in loss of control of your vehicle or the trailer, causing damage to property, injury, and/or death.

Breakaway Switch

In the event of an accidental separation of the tow vehicle and the trailer, the breakaway switch will set and lock the trailer brakes for a sufficient length of time to stop the trailer. The switch is activated when the wire attached to it and to the tow vehicle pulls out the small pin in the front of the unit.

When the trailer is connected to the tow vehicle, the breakaway switch loop should be attached to the permanent frame of your hitch. When disconnecting the trailer from the tow vehicle, remove the wire loop from the frame. Do not remove the pin from the switch because this will apply the trailer brakes.

⚠ WARNING

Do not use the breakaway switch as a parking brake. If the battery should go dead, the trailer parking brake would no longer be applied. Failure to comply could cause damage to property, injury, and/or death.

Loading

When towing a trailer, you are subject to new and different challenges on the highway than you may have previously encountered. Towing a trailer is no small responsibility and should be undertaken with great care and safety first in mind. An accident with a tow vehicle and trailer can have much greater consequences than carelessness with a small car. Like an airline pilot who is responsible for expensive equipment and many lives, you should take your responsibilities as a tow vehicle driver very seriously and learn all you can about doing the job safely and well. Balancing the load and preparing the trailer and tow vehicle are critical to safe handling.

One of the most critical aspects of safely towing a trailer is knowing the weights involved and where they are placed. The first thing to determine is how much is being towed and confirming that it is within the capacities of the equipment being used. Determining where the load is placed is critical to the way your rig will handle on the road.

Know what your trailer weighs loaded. Load your trailer including water, propane, etc and take it to a public scales. Weigh each axle of your vehicle. Refer to your axle weight and tire limits to see if you are within a safe range; [see Specifications on page 4-3](#). Total all axle weights, ensuring you are below the Gross Vehicle Weight Rating (GVWR).

Make sure your load is balanced. Do not load too much on one side. A balanced load is much easier to tow or drive. Front to back balance is also important. Step back and look at your trailer, making sure that there is not too much weight on the hitch, or on the rear of the trailer. Secure all items, as loose items can cause damage and become a safety issue. The Cargo Carrying Capacity tag shown below is installed on every trailer and can be found on the inside of the screen door on your trailer.

RECREATIONAL VEHICLE TRAILER CARGO CARRYING CAPACITY
VIN #####
THE WEIGHT OF CARGO SHOULD NEVER EXCEED
XXX kg or XXX lbs
CAUTION
A full load of water equals XXX kg or XXX lbs of cargo @ 1 kg/L (8.3 lb/gal)

Airstream weighs the trailer as finished to arrive at the trailer's weight. That number is subtracted from the GVWR of the trailer and listed under THE WEIGHT OF CARGO SHOULD NEVER EXCEED on the tag. The total weight of any and all cargo, including dealer modifications or additions, water, and propane should never exceed the number listed.

As cargo is added, removed, or shifts in location, the weight on the axle(s) and hitch will change. Also, the hitch and axle weights will change as a consequence of the weight of the LP tank(s) diminishing from use of propane, and/or the transfer of weight as a consequence of water in the fresh water tank being used and transferred to the grey and black tanks. In shorter units, rear bath models especially, when the LP tanks are empty and fresh water has been transferred to the grey and black holding tanks, the reduction in hitch weight may be significant. For this reason, we recommend that the grey and black tanks be emptied before traveling.

When loading the trailer, keep the following in mind:

- GVWR
- GAWR
- Tire Weight Rating
- Cargo

⚠ WARNING

Never exceed these critical weight limits/ratings. Your safety depends on not overloading the trailer, axles, and tires.

Towing

Weighing Your Trailer

The illustration below shows how to weigh the trailer on scales.

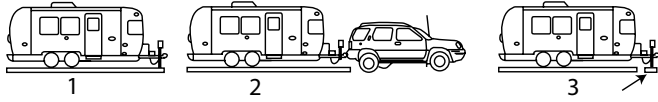

1. Trailer's total weight, cannot exceed GVWR.
2. Trailer's weight on axles cannot exceed GAWR.
3. Weight on trailer tongue.

To determine that the GAWR is not exceeded, it is necessary to load all of your allowable personal cargo and variable weights. Then hitch the trailer to the tow vehicle with load equalizing hitch properly adjusted.

Chock wheels and place the trailer on a scale with both axles only on the scale (see illustration). If the weight on the axles exceeds the axle system's GAWR, then some of the personal cargo must be redistributed forward in order to place some of this weight on the tongue.

The tongue weight should be 10 to 15% of the trailer's total weight, and must not exceed the tow vehicle's or the hitch's maximum weight rating. To determine tongue load, unhitch tow vehicle and place the tongue hitch post on a scale. The trailer must be properly loaded as determined above, with your allowable personal cargo and variable weights.

Use a scale, such as a bathroom scale, that has a lower weight limit than your tongue load to check the tongue weight by using the following method (see illustration).

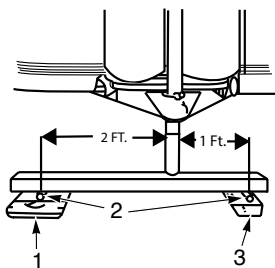

1. Bathroom Scale
2. Pipe
3. Wood Support

Place a piece of wood of approximately the same thickness as the bathroom scales on the ground in line with the trailer hitch jack as shown. It should be so spaced that a short piece of pipe or other round piece will lay exactly one foot from the centerline of the jack extension.

Place the scales so that another round piece can be exactly two feet from the centerline of the jack extension in the other direction. Place a 4x4 piece of wood on the two round pieces and screw the jack extension down on the top of the 4x4 until the tongue of the trailer is supported by it. Multiply the scale reading by three. This will be the tongue weight of your trailer. If you exceed the capacity of the bathroom scales, increase the two-foot dimension to three or four more feet, but always multiply the scale reading by the total number of feet between the wood and scales.

NOTE

Be sure trailer is level when reading scales.

Hitching Up

The process of hitching up your trailer is something that will become almost second nature with practice. The following section includes proper hitch load distribution. Proper training on connecting your trailer to a tow vehicle is essential for safety. Please see your dealer or other qualified personnel for instruction on the proper hitching of your trailer. Safety chain use on the hitch is required in all states.

⚠ WARNING

Always make sure coupler is properly attached and latched before towing, and that safety chains are properly attached. Safety chain use on the hitch is required in all states.

7-Way Plug

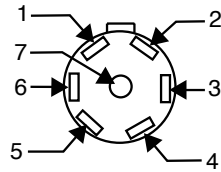

1. Black, 12-Volt (+)
2. Green, Clearance Lights/Taillights
3. Red, Left Turn/Stop
4. White, 12-Volt (-)
5. Blue, Brake
6. Brown, Right Turn/Stop
7. Blank

NOTE

The 7-Way Plug is spliced to the main harness in the area of the 12-volt distribution panel in front of the trailer.

Equalizing Hitch Load Distribution

When a trailer is properly hitched up to a tow vehicle with a load equalizing hitch, approximately 1/3 of the trailer's tongue weight will be on the trailer's axles and 2/3 will be transferred to the tow vehicle. One third of this weight transfer will be carried by the front wheels and 1/3 by the rear wheels of the tow vehicle (See illustration). Thus, the tire load of each wheel on the tow vehicle will be increased by 1/6 of the trailer's tongue weight. The tire air pressure of the tow vehicle should be increased to compensate for this additional weight. Refer to the vehicle's owner's manual for this information.

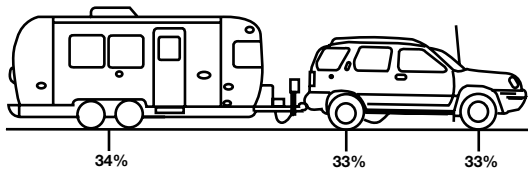

WARNING

The tongue weight should be approximately 10 to 15% of the trailer's total weight. Under no condition should it exceed the tow vehicle's hitch rating. Please refer to the tow vehicle's documentation for your vehicle's hitch rating information.

Wireless Observation System

Your travel trailer is equipped with a Wireless Observation system consisting of a camera mounted at the rear of the trailer and a wireless monitor for your tow vehicle. This system will allow you to see what is behind you while towing and provide visibility when backing up the trailer.

WARNING

Carefully read and understand all manufacturer's instructions provided in your owner's packet prior to operating.

Towing

Safety

The transporting of people in the trailer puts their lives at risk and may be illegal. The trailer does not have seat belts, therefore, it is not designed to carry passengers.

WARNING

Never transport passengers inside a trailer. Towing a trailer with passengers inside is unsafe and could result in death or serious injury.

Securing the Door

Before towing your travel trailer, secure the main door by locking both the door handle and deadbolt from the exterior using the keys. For instructions on how to properly lock the door, see [Main Door](#) on page 6-3.

WARNING

BEFORE TOWING

The door handle and deadbolt must both be locked from the exterior using the keys. Never lock them before shutting the door. Failure to fully lock both the handle and deadbolt using the keys may result in the door vibrating open during travel.

Practice

We want every Airstream owner to be a safe and courteous driver. A few hours of towing practice in a large, empty parking lot will make pulling your trailer over the road much easier. Mark off two corners of the parking lot for left and right turns. These corners may also be used to practice backing and parking.

Towing

General Information

After thoroughly inspecting your hitch, brakes, and tires, you should be ready to tow. Check traffic, signal when you are about to pull away, and start slowly. Look often in your mirrors, and observe the action of the trailer, then carefully move into the proper lane of traffic. Remember that the trailer wheels will not follow the path of the tow vehicle wheels, therefore, wider turns are necessary when turning to the left or to the right.

⚠ WARNING

Truck or trailer type fender, door grip, and rear view mirrors are a must for maximum visibility and required by law in most states.

Tracking Observation

Observe that the tracks made by the trailer wheels are distinctly different from those made by the tow vehicle. Studying this will make it easier for you to correct mistakes.

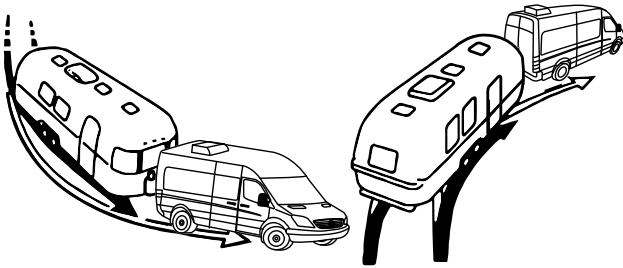

Cooling System Overload

When towing, you might encounter a temporary cooling system overload during severe conditions, such as:

- Hot days when pulling on a long grade
- When slowing down after higher speed driving
- Driving with long, idle periods in traffic jams

If the tow vehicle's temperature gauge or indicator light indicates overheating, and the air conditioner is on, turn it off, pull over in a safe place, and apply the emergency brake. Increase the engine idle speed. Lift the engine hood and check for fluid leaks at the radiator overflow outlet. Ensure that all drive belts are intact and the radiator fan is turning. If you have a problem, have it fixed at the next opportunity. If there is no problem, the light should go off, or temperature should come down within one minute. Proceed on the highway a little slower, and resume normal driving after 10 minutes.

⚠ WARNING

Never open a radiator cap when the tow vehicle is hot. Check the coolant level when the vehicle is cool.

Downhill and Non-level Driving

When going downhill in dry weather, downshift so that engine compression will slow the whole rig down. Take dips and depressions in the road slowly and do not resume normal driving speeds until you are sure that the trailer wheels are clear of the dip.

⚠ WARNING

On slippery pavement, do not use engine drag to help slow down as this may cause the rear wheels of the tow vehicle to skid. On icy pavement, drive slowly and, if you feel the tow vehicle skidding, gently apply the trailer brakes only. This will bring the tow vehicle and trailer back into a single line. Chains do not help trailer wheels.

Off-Road Towing

When driving in mud and sand, let the momentum carry the rig through. Apply power gently and use as little as possible. Stay in the tracks of the vehicle ahead and keep the tow vehicle in the highest possible gear. If you get stuck, it is best to tow out the entire rig together without unhitching.

When Being Passed

Despite the best hitch, you will notice that whenever a large bus or truck overtakes your rig, the displaced air first pushes the trailer rear slightly to the right and then affects the front. It may be necessary to steer very slightly, momentarily, toward the bus or truck to help compensate for the sway induced by the passing vehicle. Do not apply the vehicle brakes, as this can tend to exaggerate the situation. You may find, however, that briefly applying the trailer brakes with your manual control will help eliminate sway.

On a two-lane road, cars may line up behind you because you travel at a lower speed. It is both courteous and sensible, if you are able, to signal, pull onto the shoulder, and let them pass. Your trailer is designed to be towed easily at any legal speed, so if you are not careful, you may be inclined to forget it is there.

Passing

On freeways or expressways, pick the lane you want and try to stay in it. Always maintain plenty of space between you and the car ahead, at least the length of the tow vehicle plus trailer, for every ten miles per hour. Remember that in order to pass another vehicle, you will need longer to accelerate. You must also allow for the length of the trailer when returning to the right hand lane.

Backing Up

When backing up, the important thing to remember is to do everything slowly and to immediately correct if you see the trailer turning the wrong way. Concentrate on the rear of the trailer. With your tow vehicle and trailer in a straight line, back up slowly and turn the bottom of the steering wheel in the direction you want the trailer to go. Watch out of the window or in the mirror until the rear of the trailer is pointing in the desired direction. Your tow vehicle will be following the trailer in an arc. Straighten the tow vehicle and trailer by turning the steering wheel more sharply, and then, when they are in line, straighten the steering wheel.

Always try to back to your left because the visibility is much better. When you don't make it on the first try, it is usually much easier to pull forward to your original position and start over, or at least pull forward until the rig is straight, and then start backing.

If your spouse or traveling companion normally directs you when backing, they should position themselves forward of the tow vehicle so the driver can easily see them. Their directions should always indicate to the driver the direction the rear of the trailer should go. A little practice in a parking lot with the person giving directions can save a lot of frustration when backing into a campsite.

Stopped On a Hill

Refer to the following warning if stopped on a hill for a prolonged period of time.

WARNING

Chock the trailer wheels when stopping on a hill or slope. Leaving your tow vehicle in gear is not enough for standstill safety. Do not use trailer brakes as parking brakes.

Controlling Sway or Fishtailing

Sway or fishtailing is the sideways action of a trailer caused by external forces. It is common for travel trailers to sway in response to strong winds, crosswinds, when passed by or passing a semi-tractor and trailer, or driving downhill.

⚠ WARNING

Excessive sway or fishtailing of your travel trailer can lead to the rollover of the trailer and tow vehicle. Serious injury or death can occur. It is important that you read and understand the information in this section.

Sway or fishtailing of your recreation vehicle can be controlled and is primarily impacted by four factors:

- Equipment
- Tongue Weight
- Driving
- Corrective Measures

Equipment

When hitched together, the trailer and the tow vehicle must be level. The tires of both the trailer and tow vehicle should be in good condition and properly inflated to their recommended pressures.

Braking is a very important factor in vehicle control; [see Brakes on page 7-2](#) and [see Electronic Brake Controller on page 7-2](#).

We recommend a friction sway damper or hitch with built-in sway control be provided for your unit. Please consult your dealer regarding this equipment. For more information, [see Sway Control Device on page 7-8](#).

Tongue weight

For information about tongue weight, [see Weighing Your Trailer on page 7-4](#) and [see Equalizing Hitch Load Distribution on page 7-5](#).

Driving

This is the most important component. The tendency for the vehicle to sway increases with speed therefore, obey all speed limits and reduce speed during inclement weather or windy conditions.

Corrective Measures

If sway occurs, the following techniques should be used:

1. Slow down immediately, remove your foot from the accelerator. Avoid using the tow vehicle brakes unless there is a danger of collision. Reduce speed gradually whenever possible. If you can do so safely, use the brake hand controller to gently and progressively apply the trailer brakes. This will help to keep the vehicles aligned. Practice using the brake hand controller on a deserted parking lot. Do not wait until an emergency occurs before using it. Location of the brake hand controller is important and should be made easily accessible.
2. Steer as little as possible while maintaining control of the vehicle. Because of natural reaction lag time, quick steering movements to counter trailer sway will actually cause increased sway and loss of control. Keep both hands on the wheel. Hold the wheel as straight as possible until stability is regained.
3. Do not jam on the brakes or attempt to press on the accelerator to speed your way out of the fishtailing. Both actions make the situation worse and could cause severe injury or death.
4. Once the swaying is under control, stop as soon as possible. Check tire pressures, cargo weight distribution, and look for any signs of mechanical failure. Travel at reduced speeds that permit full control until the problem can be identified and corrected.

Sway Control Device

Although Airstream has not intruded into the hitch manufacturer's field of expertise and performed formal testing, we find the vast majority of Airstream owners purchase sway-control devices.

When passed by large trucks or when exposed to sudden crosswinds, the trailer will be pushed and this action will be felt in the tow vehicle. It is our understanding that the sway control device will reduce the amount of movement, make towing more comfortable, and add some safety. Follow the directions of the sway control manufacturer when having the device installed and when using it.

AIRSTREAM®

Section 8 MAINTENANCE

MAINTENANCE SCHEDULE	8-2	BATTERIES.	8-12
SUGGESTED MAINTENANCE AND REPLACEMENT PARTS.	8-3	Lithium Technology	8-12
Exterior Care.	8-4	Battery Management System (BMS)	8-12
TIRES	8-5	Battery State of Charge	8-13
Tire Changing	8-5	Cold Weather Usage.	8-13
Jack Location	8-5	WATER PUMP.	8-14
Tire Load and Inflation Information	8-6	Water Pump Access Locations	8-14
Proper Tire Inflation	8-6	Strainer Cleaning	8-14
Under Inflated Tires	8-6	Fresh Water Tanks and Draining	8-14
How Overloading Affects Your Tires	8-6	Drain Valves	8-14
Weighing Your Trailer Or Towed Vehicle	8-6	Fresh Water Tank Draining	8-14
Tire Care	8-6	Sanitizing	8-14
Tire Care Tips	8-7	BLACK AND GRAY WATER TANK DRAINING	8-15
Tire Inspection and Storage	8-7	Black Water Tank Dumping	8-15
Tire and Wheel Replacement	8-8	Black Water Tank Flush	8-15
Choosing a Tire	8-8	Drain Systems Cleaning	8-15
Max Load Single vs. Max Load Dual	8-8	WINTERIZING AND STORAGE	8-16
Lug Nut Torquing	8-9	Winterization Procedure	8-16
Spare Tire Carrier	8-9	Restoring Service After Winter	8-17
Tire Rotation	8-9	MAIN DOOR CARE.	8-18
AXLES AND BRAKES.	8-10	Lubrication	8-18
Axles and Bearings	8-10	Adjustment	8-18
Rubber Torsion Axle Alignment Specifications	8-10	WINDOWS	8-18
Nev-R-Lube Drums/Bearings	8-10	Sticking Windows	8-18
Nev-R-Lube Bearing Inspection	8-10	ELECTRICAL DIAGRAMS	8-19
Brakes	8-10	12-Volt Main Schematic	8-19
Breakaway Switch.	8-11	120-Volt/50-Amp Diagram.	8-20
POWER JACK.	8-11	120-Volt/50-Amp Diagram - CSA	8-21
Power Jack Maintenance	8-11	Solar Panel Wiring	8-22
		MULTIPLEX CONTROLS	8-23
		FRESH WATER LAYOUT	8-27
		FAQS AND ANSWERS	8-28

Maintenance Schedule

⚠ WARNING

Failure to maintain your trailer can cause premature and unexpected parts breakage and/or erratic operation that may be hazardous.

NOTICE

See appliance manufacturer's literature for further information.

Every 1,000 miles or 60 days

Escape Window	Check operation of latches and upper hinge.
Smoke Alarm & CO Detector	Test and replace battery as required.
Tires	Check tire pressure; see Specifications on page 4-3.
Hitch	Check for loose bolts or unusual wear.
GFI Circuit Breaker	Test and record.

Every 5,000 miles or 90 days

Main Door Latch	Lubricate with dry graphite
Exterior Door Locks	Lubricate with dry graphite.
Exterior Hinges	Lubricate with light household oil.
LPG Hold-Down	Lubricate with light household oil.
LPG Regulator	Check bottom vent for obstructions.
Wheel Lug Nuts	Torque to specifications, see Specifications on page 4-3.
Breakaway Switch	Pull pin and lubricate with household oil; see Breakaway Switch on page 8-11.
7-Way Plug	Spray with contact cleaner.
Hitch Ball	Lubricate with hitch ball lube or wheel bearing grease.
Range Exhaust Hood	Clean fan blades and wash filter.
Main Door Step	Lubricate and inspect moving parts.

Every 10,000 miles or 6 months

Tires	Inspect and rotate.
Nev-R-Lube	Visually inspect wheel bearings at tire rotation. Refer to Dexter's recommendation www.dexteraxle.com or call (574) 295-7888.
Spare Tire Carrier	Lubricate moving parts.
Windows, and Door Seals	Clean with mild detergent and apply 303 Aerospace Protectant.
Exterior	Wax.
Escape Window	Lubricate latches with silicone grease every 6 months or as needed.

Every 12,000 miles or every year

Brakes	Inspect or replace as necessary every year or 12,000 miles; see Brakes on page 8-10.
Batteries	Check terminals are secured.
LPG Tanks	Have purged by LPG supplier every year.
Seams	Check and reseal exterior seams, windows, lights, and vents as needed.
Hitch Coupler and Ball	Ensure all parts operate freely. Replace any component if worn or damaged.
Interior Cabinetry	Visual Inspection of latches Locks, Hinges and Slides. Silicone Spray as needed.
Power Jack	Inspect and lubricate; see Power Jack on page 8-11

Suggested Maintenance and Replacement Parts

Part numbers listed are Airstream part numbers and can be ordered by calling a Certified Airstream Dealer.

⚠ WARNING

Always replace the bulb or light fixture with the correct bulb for that light or matching fixture. Failure to heed this warning could cause fire, property damage, personal injury, or death.

Exterior 12-Volt Lighting

License Plate LED	PN – 514065-01
LED Clearance Light, Amber	PN – 512859
LED Clearance Light, Red	PN – 512860
LED Step Light Bulb	PN – 512490
LED Flex Light Strip	PN – 512918-02
Convenience Light (Dump Valve)	PN – 513752

NOTE: Most Exterior Lighting is LED and a replacement fixture will be required.

Interior 12-Volt Lighting

LED Galley Puck Light	PN – 513942
LED Light w/Switch	PN – 513707
LED Spot Light w/Frosted Lens	PN – 513136
LED Reading Light, Black	PN – 513930
LED Shower Light	PN – 513961
LED Nightstand Lamp	PN – 513929
Sconce, Lounge	PN – 513927
Sconce, Bath	PN – 513928
LED Edison Bulb	PN – 513972

NOTE: Most Interior Lighting is LED and a replacement fixture will be required.

Replacement Fuses

1 Amp Blade Fuse	PN – 500773-01
15 Amp Blade Fuse	PN – 500773-15
20 Amp Blade Fuse	PN – 500773-20
30 Amp Blade Fuse	PN – 500773-30

Replacement Breakers - USA Breakers

Breaker, Blade-Style, 30A (Power Jack)	PN – 514198-01
Breaker, Bryant, 20 Amp	PN – 510564-01
Breaker, Bryant, 15-15 Amp	PN – 510564-03
Breaker, Bryant, 15 Amp	PN – 510564-09
Breaker, 12V DC Type II, 10 Amp	PN – 510947-10
Breaker, 12V DC Type II, 20 Amp	PN – 510947-20
Breaker, 12V DC Type II, 30 Amp	PN – 510947-30
Breaker, 12V DC Type II, 50 Amp	PN – 510947-50

Maintenance

Replacement Rivets						
	Interior		Exterior		Underbelly	
Part Number	330127-05	330127-08	330126-03	330126-04	330034-100	330038
Rivet Name	AD45ABS	AD48ABS	SSD44SSBS	SSD45SSBS	AD68ABSLF	AD54ABSLF
Head Style	Dome Head	Dome Head	Dome Head	Dome Head	Large Flange	Large Flange
Body Diameter (Inches)	0.125 (1/8)	0.125 (1/8)	0.125 (1/8)	0.125 (1/8)	0.187 (3/16)	0.156 (5/32)
Hole Size	0.129-0.133	0.129-0.133	0.129-0.133	0.129-0.133	0.192-0.196	0.160-0.164
Drill Number	30	30	30	30	11	20
Grip Range In (Inches)	0.251-0.312	0.376-0.500	0.188-0.250	0.251-0.312	0.376-0.500	0.126-0.250
Length Under Head (Max. Inches)	0.453	0.640	0.400	0.438	0.690	0.415
Head Diameter (Nominal)	0.250	0.250	0.250	0.250	0.625	0.468
Head Height (Max. Inches)	0.040	0.040	0.040	0.040	0.092	0.075
Typical Sheer Strength (lb.)*	155	155	520	520	85	225
Typical Tensile Strength (lb.)*	235	235	600	600	135	350

*Values shown are a guide only and may vary depending upon the application.

Replacement Filters	
Range Hood	PN – 512210-100
Merv 8 Return Grill Filter	PN – 382766-01
Merv 8 Filter Sponge	PN – 382766-02

Interior Touch-up	
Seamfil, Countryside Oak	PN – 360301-39
Seamfil, Blackened Legno	PN – 360301-40
Fil Stick, Country Side Oak	PN – 360406-10
Fil Stick, Blackened Legno	PN – 360406-01
Stain Marker, Country Side Oak	PN – 365504-05
Stain Marker, Blackened Legno	PN – 365504-10

Exterior Care

The following exterior care products are recommended by Airstream. Read and follow label directions. Exterior sealant should be checked and resealed once a year.

Walbernize Super Seal (PN - 28433W) - Use on exterior aluminum of trailer; recommend two applications a year.

Acryl-R Seam Sealer (PN - 28430W-01 [16 oz can-Gray]) - Use anywhere a fine bead of Gray sealant is required.

AdSeal Premium Quality Sealant Adhesive (PN - 365330-01 [10 oz tube-White]) - Use anywhere a thicker bead of White sealant is required.

AdSeal Premium Quality Sealant Adhesive (PN - 365330-03 [10 oz tube-Gray]) - Use anywhere a thicker bead of Gray sealant is required.

AdSeal Premium Quality Sealant Adhesive (PN - 365330-04 [10 oz tube-Black]) - Use anywhere a thicker bead of Black sealant is required.

Tires

Your trailer is equipped at the factory with name brand trailer tires. Most Airstream dealers cannot make adjustments to tires. An Airstream or tire dealer that handles that particular brand must do this. If you experience tire problems, contact the nearest dealer.

Tire Changing

To change a tire with a jack, see the label affixed to the underbelly located to the rear of the wheels. This label reads **JACK** with an arrow pointing to a plate riveted to the mainframe rail where the jack head must be placed.

Jack Location



NOTE

Airstream does not supply a jack with the trailer.

Leveling blocks can be used instead of a jack to change a flat tire. Position the leveling block under the trailer's good tire. This will raise the flat tire clear of the ground. All tire and wheel assemblies are balanced at the factory. Be sure to rebalance the tire and wheel assemblies each time a tire is changed.

⚠ WARNING

Do not exceed the maximum speed rating of the tires installed on your trailer. Failure to heed this warning could cause catastrophic tire failure resulting in property damage, personal injury, and/or death. Refer to the Tire Safety Information Addendum in your Owner's packet for more information.

⚠ WARNING

Never attempt to change any tire on the trailer without securely chocking the trailer's remaining wheels. Never position yourself in a manner where a raised trailer can come down on you if it should become dislodged from a jack or ramp.

⚠ WARNING

When removing aluminum-forged wheels from spindle, it is very important to mark them to ensure the wheel is placed in the same position of the drum when reinstalling. If the aluminum-forged wheel is to be mounted on a different drum, it is important to sand all loose corrosion from the mating surfaces.

⚠ WARNING

WHEEL SEPARATION CAN OCCUR

1. **When removing/reinstalling wheels: torque lug nuts at the beginning of the first trip, and at 5, 25, and 50 miles.**
2. **Thereafter, check lug nuts before each trip.**
3. **Following winter storage, check lug nuts before beginning a trip**
4. **Following excessive braking, inspect and torque.**

⚠ WARNING

Use a torque wrench to tighten lug nuts. Tightening by hand or with an impact wrench is not recommended. For lug nut torque values, see [Specifications on page 4-3](#).

In an emergency, remove a flat tire. The independent suspension of the rubber torsion axle allows four- or six wheeled units to be safely towed on three or five wheels for a short distance (100 miles maximum) and only at a low speed (30 MPH).

Be especially careful when crossing holes or dips in the road. Under these circumstances, it is good practice to set your rear view mirrors so that you can observe your tires at all time.

Tire Load and Inflation Information

Maintaining proper tire inflation pressure is essential for both tire safety and performance.

Proper Tire Inflation

The level of air in your tires affects your vehicle's overall performance. A maximum inflation pressure specification is found on the trailer's exterior on a metal tag riveted to the lower front, roadside of the trailer, as well as on the original equipment tires.

Air pressure should be checked based on the load on each individual tire. Cold Inflation Pressure should be adjusted to handle the maximum tire load, and all tires on the axle should carry the same inflation pressure. *Cold tire inflation pressure* is the tire pressure checked in the morning before you drive more than a few miles, or before rising ambient temperatures or the sun's radiant heat affects it.

Under Inflated Tires

Under inflation brings a higher risk of damage due to road hazards, reduces casing durability, causes a loss in fuel economy, and will result in uneven or irregular tire wear. Severe under inflation brings about an increased risk of tread separation, handling difficulties, and possible tire failure, caused by overheating.

When minimum inflation pressure requirements are not met, tire durability and optimum operating conditions are compromised. Tire inflation pressure should always meet the guidelines for vehicle weight.

Observe the following:

- It may be necessary to inflate your tires at a truck stop or truck service center in order to achieve adequate air pressure for your trailer's needs.
- Only permanent air seal metal valve caps should be used.
- Be safe - if a tire has been run in a 20% under inflated condition, it must be dismantled and inspected by a trained professional. It should not be aired up without a full inspection or without using a safety cage. Use a calibrated gauge. If your tire is rated for higher inflation pressures, a special gauge will be required designed for larger tires.

⚠ WARNING

Due to RISK OF EXPLOSION damaged tires or tires run with more than a 20% underinflation (approximate) must be dismantled, inspected by a qualified technician, and should not be inflated without using a safety cage.

- Do not bleed air from warm tires to reduce pressure buildup.
- Do not inflate tires to cold psi rating beyond rim specifications.

How Overloading Affects Your Tires

Tire pressure is what enables your trailer tire to support loads, thus, overloading can have serious consequences. Too much weight can cause stress on the suspension system components, brake failure, handling and steering problems, irregular tire wear, and possible tire failure. If you discover your tires cannot handle the load, lighten the weight of the load on your tires.

Weighing Your Trailer Or Towed Vehicle

Since a trailer or towed vehicle adds to the load on the tires, it is crucial to properly weigh towed vehicles; [see Loading on page 7-3](#) and [see Weighing Your Trailer on page 7-4](#).

Tire Care

The most important function of tires is to provide traction while moving and grip when steering or stopping. The tires on your trailer are designed for highway use and must be properly maintained in order to maximize tire life, as well to provide a safe mode of transportation.

Tire Care Tips

To reduce the risk of tire failure, we strongly recommend the following:

1. Check the pressure in your tires, including your spare, at least monthly when the tires are cool (after the vehicle has been stopped for three hours and then driven less than one mile). Do not reduce pressure when tires are hot. Use a tire gauge to check pressure and maintain it at the recommended level.
2. Never overload your tires. Heed the maximum load-carrying capability of your tires.
3. Check your tires frequently for scrapes, bulges, separations, cuts, or snags resulting from use. See your tire dealer immediately if any such condition is discovered.
4. Never operate your vehicle in excess of lawful speeds, the maximum speeds justified by driving conditions, or in excess of speeds recommended for the tires you are using.
5. Make every effort to avoid running over objects that may damage the tire through impact or cutting, such as chuck holes, glass, metal, etc.
6. Never drive on smooth tires. Tires should be removed when 2/32 in. of tread depth remains. In most states, it is illegal to drive with less than 2/32 in. remaining tread depth.
7. Park out of the sun whenever possible when in warm climates. In desert regions, use tire covers to prevent ultra violet light deterioration to tires.

Tire Inspection and Storage

Before taking your trailer on a trip or when removing it from an extended storage period, make it a practice to inspect the overall condition of your tires. Check for any type of condition or damage that might result in failure. A thorough check should include both inside and outside sidewalls, tread area and the condition of hardware such as valve stems, valve caps, and wheels. The tread should be checked for any unusual wear, cracking, penetrations, and/or cuts. An uneven wear pattern can indicate misalignment or worn suspension parts.

Since many RVs are used seasonally and sometimes stored for extended times, it is possible that tires will take many years to wear out. Tires, as any rubber product, will age over time. If tires show cracking in the sidewall or tread surfaces that are more than 2/32 in. deep, they should be replaced before your next trip or vacation. Store your RV in a cool, dry area away from major heat sources and extreme cold. An enclosed storage area is best with no exposure to electromagnetic sources such as generators or transformers. If you must keep your trailer outside, cover your tires from direct sunlight. Take your trailer to your tire dealer for service to check or correct any of these conditions.

Maintenance

Tire and Wheel Replacement

It is possible to replace your tires with a different size, in some instances. If there is a reason to replace your tires with a different size, make sure the following checks are made before the purchase:

- Does the replacement tire have the load capacity that is needed for my trailer and will it fit properly inside the wheel well?
- Will the overall diameter difference affect the braking system?
- Is the increase in air pressure compatible with the maximum rated pressure stamped on the rim?

Most trailers are towed at or near maximum loads during hot weather and then are left idle for months. In normal use, oils in the tire come to the surface during flexing and protect the rubber from ultraviolet light. But when the trailer tires sit idle too long, natural aging may cause the rubber to crack prematurely, especially in the sidewall area. Trailer tires over 5 years old should be inspected by a tire expert for cracking and replaced even if it has no apparent tread wear.

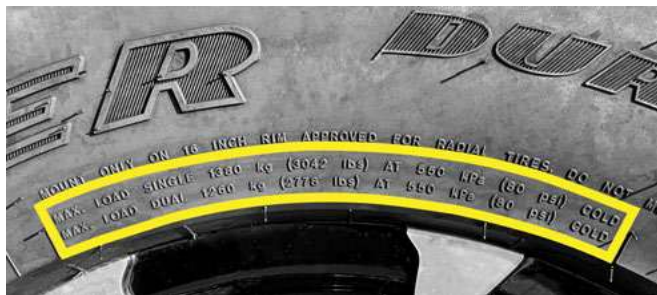

Choosing a Tire

Every tire sold in the United States has a tire rating stamped on the sidewall that shows a tire's maximum load at a defined pressure. Use the example above to help locate the max load rating in pounds (lbs) and tire pressure in pounds per square inch (psi) on your original equipment tires. Choose a tire with equal load ratings. For tire size, inflation and load specifications, [see Specifications on page 4-3](#).

Max Load Single vs. Max Load Dual

Max Load Single refers to the tire rating for applications with only one wheel on each end of a single axle. *Max Load Dual* refers to the tire rating for dually wheels, where there are two wheels on each end of an axle for a total of 4 wheels on a single axle.

Don't confuse the terms Single and Dual with Tandem. A tandem axle refers to trailers with two axles, one behind the other.

For Airstream Travel Trailers, refer to the Max Load Single rating..

⚠ WARNING

Do not mismatch wheels and tires.

Axle systems are installed with hubs and drums that are compatible with many wheels used in the recreational vehicle industry that have matching bolt patterns. If the original manufacturer-installed equipment is in need of replacement, the wheel manufacturer should be contacted for proof of compatibility prior to replacement and use.

Customers replacing original with equipment that has not been tested for compatibility must ensure the replacements are compatible to the hub and drum assembly installed. Such elements of compatibility include, but are not limited to:

- Diameter of the hub-mounting surface.
- Stud length and diameter.
- Location and number of studs.
- Center hole diameter for the wheel.
- Wheel-mounting offset from the rim center.
- Rated capacity of the wheel.
- Wheel fastener torque.
- Wheel nut size and shape.
- Impact of any added wheel accessories (such as decorative center caps) that could affect proper seating of the wheel to the hub surface.

Refer to the following table for wheel specifications.

Wheel Specifications		
Size/Center Size In Inches	Lug Pattern	Model
16 x 6 / 5.5	6	All
All wheels have zero offset.		

Lug Nut Torquing

Trailer wheels must carry much higher loads per wheel than passenger car or truck wheels. Each wheel may carry 1000 pounds and higher. Furthermore, wheels on tandem axle trailers do not steer, and are subjected to very high side load stress whenever the trailer makes a tight turn. When going around corners, especially on slow, tight turns, the wheels are subject to very strong side loads. This tends to flex the wheel and gradually loosen the wheel nuts. Although the materials and manufacturing methods are maximized for this kind of service, these extra loads can cause stress, which can result in flexing and loosening of wheel nuts.

Before each trip and any time a wheel is replaced, be sure to tighten the wheel nuts, following the lug-pattern sequence shown below. If the wheel was replaced, check the torque every 5, 25, and 50 miles.

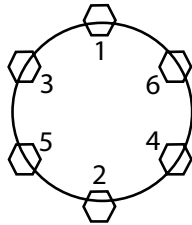

If you notice wheel wobbling, or hear a rattling sound coming from a wheel, especially at low speeds, a wheel lug nut may have come loose. This problem is usually caused by improper tightening, or by faulty or damaged lug bolt threads.

If suspicious of a loose lug nut, safely stop vehicle as soon as possible. Put up warning devices and check the tightness of all the lug nuts. Tighten all lug nuts to the specified torque, using a torque wrench. If stud threads are damaged or faulty, get professional service help.

⚠ WARNING

Use a torque wrench to tighten lug nuts. Tightening by hand or with an impact wrench is not recommended. For lug nut torque values, see [Specifications on page 4-3](#).

Spare Tire Carrier

The spare tire for Airstreams are stored under the front of the trailer. The front handle of the tire carrier is a 1 in. tube protruding out from under the front A-frame on the curbside. It is secured by a bracket and bolt along the inside of the A-frame rail. Removing the bolts allows the front of the tire carrier to be lowered and the spare tire to be removed.

⚠ WARNING

The spare tire carrier is designed to carry an undamaged tire and rim assembly of the type and size specified for the trailer. Never place a severely damaged wheel assembly with a damaged partial tire, or a rim only, in the carrier.

Tire Rotation

(10,000-mile intervals)

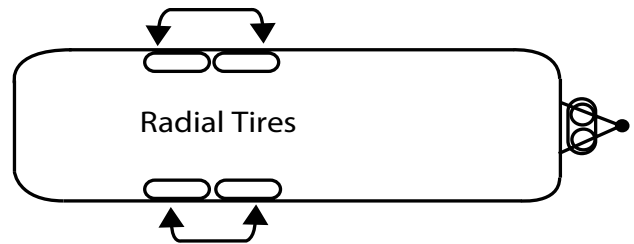

Axles and Brakes

 The following sections provide an overview of the inspection and maintenance requirements of the axle and brake components, as well as requirements for the breakaway switch. Consult the Dexter Operation Maintenance and Service Manual for detailed axle and brake information, and required maintenance intervals. It can be found by scanning the QR code above or visiting <https://www.dexteraxle.com/>.

⚠ WARNING

Read and follow all warnings and cautions and adhere to all required maintenance intervals found in the axle and brake component manufacturer's manual. Failure to properly maintain these components could lead to an accident, resulting in serious injury or death.

Axles and Bearings

⚠ WARNING

Never apply heat to the axle tube because the rubber providing the spring torsion action will be severely damaged.

Rubber Torsion Axle Alignment Specifications

Toe-In and Camber Specifications	
Toe-In each side 1/16 in.	Tolerance 1/8 in. + or -
Camber each side 3/4 degrees positive	Tolerance 3/4 degrees + or -

Nev-R-Lube Drums/Bearings

Dexter's Nev-R-Lube bearings are comprised of opposed tapered roller bearing cones sealed inside of a precision ground, one-piece double cup arrangement. These bearings are designed with a small amount of axial end-play. The end-play is essential to the longevity of the bearings service life.

Nev-R-Lube Bearing Inspection

1. Jack the trailer at the marked **JACK** location pad behind the axle on the main frame.
2. Check for excessive wheel end-clearance by pulling the tire assembly toward you and pushing the assembly away from you. Slight end-play is acceptable (0.001 to 0.010 in.).
3. Rotate the tire slowly forward and backward. The wheel assembly should turn freely and smoothly.
4. Excessive wheel end-play, restriction to rotation, noise, or bumpy rotation should be remedied by replacing the bearing unit.
5. Bearing units should be inspected when tires are rotated, or at least every year or 12,000 mi., whichever comes first.

A slight amount of grease-weeping from the seal area is normal. Excessive leakage may indicate abnormal bearing operation. See the Dexter Operation Maintenance and Service Manual for bearing end-play inspection, drum removal/installation, and bearing replacement procedures.

NOTICE

Airstream recommends that a qualified Dexter service technician perform these procedures due to the need for specialized tools and training.

Brakes

Brakes must be inspected and serviced immediately if performance loss is indicated. With normal use, servicing at 12-month or 12,000-mile intervals is usually adequate (whichever occurs first). With increased usage, this work should be done more frequently as required.

Breakaway Switch

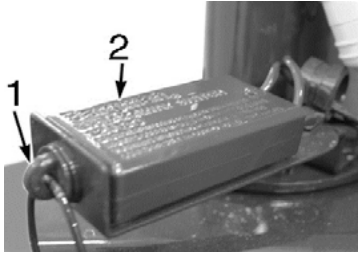

1. Pin
2. Breakaway Switch

To prevent corrosion within the breakaway switch, pull the pin out and spray the inside of the switch through the hole with an electric contact cleaner (such as Spra-Kleen). Applying a drop of light household oil on the pin and the groove near the base of the pin will allow the pin to operate freely. Immediately reinsert the pin. Perform this procedure every 90 days.

⚠ WARNING

Allow no more than 20 to 30 seconds pin separation as damage to brake magnets may occur.

Power Jack



The power jack manufacturer's owner's instructions and parts list can be found by scanning this QR code and navigating to the instructions on Barker's website at <https://www.barkermfg.com/>. The following are basic maintenance requirements. Please refer to Barker's instructions for jack and bubble level adjustments, installation, and additional maintenance.

Power Jack Maintenance

- Once a year, the powerhead should be removed, and a liberal amount of grease (preferably grease with a high melting point) applied directly to the coupling on which the drive pin rests. Do not pour oil into the top of the jack post.
- Once a year, the housing cover should be removed and the gears inspected for proper lubrication. Remove all four screws and tap around the edge of the housing to free the cover. Do not use or insert a screwdriver blade to remove the cover, as it may damage mating surfaces. If lubrication is needed, use Mobilith SHC™ 460 or equivalent. Clean the mating surfaces before replacing the cover.

⚠ WARNING

Avoid the risk of injury to yourself and others. Keep hands and feet from under the foot plate when using the jack. Do not use or install dolly wheels on the power jack. Do not operate the toggle switch with the manual crank handle in place. Failure to comply could result in serious injury.

NOTE

When operating the power jack, pause briefly between switching up and down. Rapidly switching from up or down may cause the breaker to trip, momentarily interrupting power to the jack.

Batteries



Your Airstream Travel Trailer is equipped with two 100Ah 12V LiFePO4 deep cycle batteries. The batteries are located in a battery box behind the LP tank cover on the A-frame.

Lithium Technology

Airstream's lithium batteries require no new hardware, or complicated setup, and are a drop-in upgrade. They are designed to outperform traditional lead acid batteries and offer more usable energy. The Lithium batteries have a life span of approximately 3000-5000 cycles. A cycle is determined by a discharge and a charge. How many cycles a lithium battery can sustain is determined by how depleted a battery is discharged, before it is charged. A battery that is only discharged 50% will have more cycles than a battery that is constantly discharged to 0%.

Lithium batteries provide longer life and faster charging than lead acid batteries, while still providing over 80% of the rated capacity, after thousands of cycles. If the batteries are completely depleted, it will take approximately 8 hours to charge the 200Ah battery bank, at 25 amps.

Unlike lead acid batteries, which require water replacement, lithium batteries require no active maintenance. The use of lithium batteries also provides the benefit of delivering more energy at typically half the weight of a traditional battery.

⚠ WARNING

An owner's manual for the lithium batteries is provided in the Airstream Owner's Packet. Make sure to read, understand, and follow all information, such as Notes, Cautions, and Warnings, before operating.

Battery Management System (BMS)

A BMS is crucial in ensuring safe operation of any lithium battery. The BMS monitors cell voltages, currents, and temperatures to make sure they are operating in a safe range. The BMS is sealed internally and will shut the battery down should any fault condition occur. The battery will restart once the fault condition is cleared. The following, are features of the BMS:

- Over/under voltage protection
- High current protection/short circuit
- High temperature protection
- Low temperature charging protection
- Cell balancing

NOTICE

Even though the BMS will protect against issues from overcharging, it should be avoided. The recommended specs are 14.4-14.6 bulk/absorb and below 13.6 float.

The BMS will shut the batteries down when the battery voltage drops below approximately 11.5 VDC. When the batteries shut down, due to Low Battery Cut Off (LBCO), the battery disconnect switch will remain in the position it was in, prior to the batteries shutting down.

To bring the batteries out of LBCO Mode, 120-volt power needs to be present, as a voltage of 11 VDC or greater needs to be applied across the battery terminals.

If the trailer is disconnected from shore power, before the batteries are charged, the batteries could go back into LBCO Mode. Bringing the batteries out of LBCO Mode is essentially "waking up" the batteries and allowing them to take a charge.

NOTE

If the batteries are in LBCO Mode and it is below 35°F, turn the "Battery Heater" switch to "ON" before performing the wake up procedure.

NOTE

The BMS will not allow a charging current if the batteries internal temperature is below 25°F and it will not allow a charging or discharging current above 135°F.

Battery State of Charge

The heated batteries consume an average of 1.8 amps. Testing indicates, that at 0°F, with no insulation, the heater would be on about 30% of the time. With no other loads or charging, the batteries would give approximately 185 hours of heat capability before the batteries would go into LBCO shutdown.

Voltage	Capacity	Amp Hours Remaining
14.4V	100%	200
13.6V	100%	200
13.4V	99%	198
13.3V	90%	180
13.2V	70%	140
13.1V	40%	80
13.0V	30%	60
12.9V	20%	40
12.8V	17%	34
12.5V	14%	28
12.0V	9%	18
10.0V	0%	0

NOTE

Values are based off a testing environment with the batteries at 100% capacity.

NOTE

The system is calibrated at Airstream, however, if the batteries are disconnected or fully discharged, past the state of BMS protection, the Smart Shunt will need to be recalibrated. To do so, the batteries must be fully charged to a peak voltage of 14.3 volts. If the shunt is not calibrated correctly, the SOC status in the Airstream Smart RV Control app will appear dashed out. The converter has a maximum charge time of 4 hours, which may not be long enough to fully charge the batteries. To continue charging, disconnect the shoreline power supply and reconnect. This will allow the converter to continue charging for another 4 hours.

Cold Weather Usage

Lithium-ion batteries may not charge effectively if the internal temperature drops below 35°F (1.6°C). An internal heating element and switch have been added to allow battery usage and charging in cold weather.

The switch is on the side of the battery box. If the red portion of the switch is visible, the battery heaters are ON. When the switch is on, the heater will automatically activate when the internal temperature drops below approximately 35°F (1.6°C) and will shut off when the internal temperature exceeds approximately 45°F (7.2°C). The switch should be turned OFF when storing your trailer to prevent battery discharge.

NOTE

It is recommended that the battery heater's be turned ON if the outside ambient temperature will drop below 35°F.

Water Pump

Water Pump Access Locations

The water pump and strainer are located behind a false panel next to the power center. They are accessible by removing the false panel coupled with the attached vent cover. The false panel will pop off by pulling at the top with your finger tips, using a bit of force. Once open, the false panel and flexible vent duct will pull out far enough to gain access.

Strainer Cleaning



Locate the strainer housing (on the water line leading to the water pump inlet). Remove the transparent bowl (turn counterclockwise), and carefully pull out the strainer/screen. Clean and rinse with water (use a household detergent if necessary). Reinstall the strainer and bowl, being careful not to damage the seal. The bowl collects sediment and should be positioned under the housing as depicted above. Check for leaks prior to resuming normal operation.

Fresh Water Tanks and Draining

Drain Valves



The fresh water line and tank drain valves are on the trailer's exterior for easier access. Between the tires, you will see a galvanized steel box a few inches lower than the trailer frame. The two brass valves are line drains. The stainless steel valve is for draining the fresh water tank.

Fresh Water Tank Draining

Pumping the water out with the self-contained water pump can empty the fresh water tank. Simply turn on the pump switch and open a couple of faucets until the water will no longer drain out. Be sure to watch closely and turn the pump off when the tank runs dry. Pump damage can occur if the pump runs dry for more than a few minutes.

Sanitizing

Potable water systems require periodic maintenance to deliver a consistent flow of fresh water. Depending on use and the environment the system is subject to, sanitizing is recommended prior to storing and before using the water system after a period of storage. Systems with new components, or ones that have been subjected to contamination should also be disinfected as follows:

1. Use one of the following methods to determine the amount of common household bleach needed to sanitize the tank.
 - a. Multiply "gallons of tank capacity" by 0.13; the result is the ounces of bleach needed to sanitize the tank.
 - b. Multiply "Liters of tank capacity" by 1.0; the result is the milliliters of bleach needed to sanitize the tank.
2. Mix the proper amount of bleach into a container of water.
3. Pour the correct amount of solution (water/bleach) into the Fresh Water tank and fill with potable water.
4. Open all faucets (hot and cold) allowing the water to run until the distinct odor of chlorine is detected.
5. The standard solution must have 4 hours of contact time to disinfect completely. Doubling the solution concentration will allow for contact time of one (1) hour.
6. When the contact time is completed, drain the tank. Refill with potable water and flush the plumbing of all sanitizing solution.

Black and Gray Water Tank Draining

To empty one or both tanks, attach the sewer hose by pressing the bayonet fitting onto the dump valve outlet and rotating clockwise until it feels solid and secure. Attach the outlet end of the hose to the sewage outlet, making sure the hose is placed so it will drain completely. Pull the main dump valve handle as far as it will go and wait until the tank is drained. Close the dump valve and partially refill the tank with clean water, and repeat the process until clean. The main holding tank must be flushed out until all paper and waste material is removed. Should solids accumulate, close the dump valve, fill the tank about half full with water, and then tow the trailer for a few miles. The turbulence and surging of the water will usually dissolve the solids into suspension so the tank can be drained. Now pull the auxiliary tank valve handle to drain the gray water tank. When dumping, the main holding tank should be dumped first, then the auxiliary holding tank. This will help to rinse the sewer line with auxiliary holding tank water. Replace the bayonet ring cap prior to traveling.

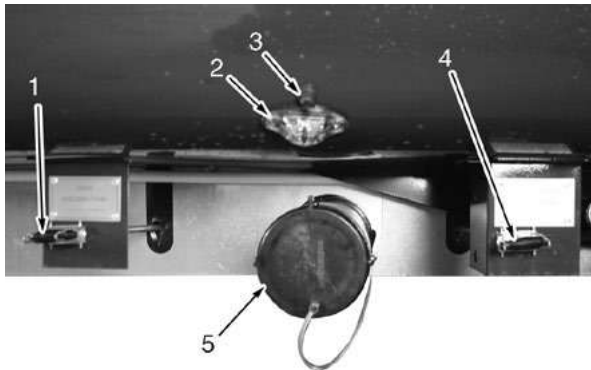

1. Black Water (Main) Dump Valve
2. Light
3. Light Switch
4. Auxiliary Tank Dump Valve
5. Drain Cap

Black Water Tank Dumping

When you are in a park and connected to a sewer outlet, keep the main holding tank dump valve closed and empty the tank every few days, or whenever it becomes almost full. Only by sending a large volume of liquid, all at once, through the main holding tank will toilet paper and other solids completely wash away.

This practice will avoid the accumulation of solids in the main holding tank, which could lead to an unpleasant cleaning job. Should solids accumulate, close the dump valve, fill the tank about half full with water, then tow the trailer for a few miles. The turbulence and surging of the water will usually dissolve the solids into suspension so the tank can be drained.

Draining the tanks as described will protect them from freezing during storage. When traveling in sub-freezing temperatures, use a winterizing solution designed for RV use. Follow the directions on the container.

Black Water Tank Flush



The trailer has a water hose connector specifically for flushing the Black Water Tank. To use, hook up a garden hose and turn it on. Within the tank, a head with multiple holes will spray the interior surface of the tank. Once the tank is about half full, turn the garden hose off and flush the water from the tank using the dump valve. The valve should be closed for the first couple of minutes, and then opened to let the water out in a rush. Repeat as needed.

It is recommended the tank flush be used on a regular basis or the holes on the spray head may become clogged.

Drain Systems Cleaning

The only cleaning agents that can be used without causing harm to the system are household ammonia and tri-sodium phosphate in small quantities. Do not use any product that contains any portion of petroleum distillates. This type of product will attack the rubber seals of your toilet and dump valve. Also, do not use any dish detergent or abrasive cleaners. All products should be marked as approved for ABS drainage systems.

NOTICE

Do not use a pipe snake on clogged drains as it could result in damage to internal components of the drain system.

Winterizing and Storage

The main consideration in winterizing your trailer is to guard against freeze damage to the fresh water system, including lines, tank, and pump; the waste drain system, including traps and tanks; the water heater, and the batteries.

When storing your trailer for short or long periods, use the same precautions as you would in your home regarding perishables, ventilation, and rain protection. In addition, for prolonged storage periods, flush out all the drain lines and the holding tanks. Also, drain the entire water system, including the water heater and the water storage tank, using the following instructions.

Winterization Procedure

Below are the basic steps to completing the winterization process. It can be time-consuming and challenging to drain all of the water from the system. These tasks require an average mechanical skill level. If you are unsure of your ability to remove all the water from the system successfully, please seek assistance.

The goal is to get all the water out of the system to prevent freeze damage. We recommend allowing the system to drain for several days. You will need an adapter with an air regulator to connect an air compressor to the city water inlet and access to an air compressor.

1. Level the trailer from side to side and front to rear. Open all faucets.
2. Turn the water pump switch to the ON position to expel water from the storage tank
3. Open all drain valves including exterior water service valve.
4. While the water is draining from the system, open and flush the toilet-flushing valve. Operate the shower head while holding it down inside the tub and drain all water from the flexible hose.
5. Turn the pump switch OFF after all water has been removed from the storage tank.
6. Disconnect outlet hose from water pump. Turn the pump on until all the water is expelled. This water, about 1/2 cup, can be caught in a towel or rag.
7. Reconnect the water pump outlet.
8. Lower the front of the trailer as far as the jack will allow and let the trailer sit until water ceases to drain (no droplets are forming), then crank the jack up as high as it will go until water ceases to drain.

9. Using the adapter mentioned at the beginning, apply, at max, 50 lbs. of air pressure to the city water inlet until only air is coming out of the faucets. You may need to open and close faucets one at a time and repeat this step several times to force out trapped water.
10. Pour a cup of approved non-toxic RV antifreeze that has been listed by a recognized testing authority such as Underwriter Lab into the lavatory, sink, and tub drains to prevent trap freeze-up.
11. Be sure to open the waste-holding tank dump valves, and drain and flush the tanks thoroughly (*this is very important as the sewage in the tanks, if frozen, could seriously damage the tanks*). Plan ahead and have this done at a dump station.
12. For best practices: remove the batteries from your trailer and store in a cool, dry place where there is no danger of freezing. It is very important for optimum life of a battery to check it periodically and to keep it fully charged. This is especially true in winter months, when the temperature may drop below freezing. If the period of storage is for 30 days or less, you may turn off the battery disconnect switch rather than remove the batteries. Continue to check and recharge the batteries as needed, at least weekly in severe weather.

NOTICE

Remove all RV antifreeze spillage from all drain and faucet parts after winterizing. Failure to do so could result in damage to the finish of the plumbing fixtures.

Optional; An additional step to winterization is to consider adding a non-toxic RV antifreeze (approved for drinking water systems) to the water lines using the pre-installed Winterization Kit.

Before beginning, read the RV antifreeze manufacturer's label for instructions specific to the antifreeze you plan to use. It may take 2-3 gallons to fill the entire system so prepare accordingly. It will be helpful to have another person watching and operating the faucets and showerheads as you follow these steps.

The Winterization Kit is near the water pump; see [Water Pump Access Locations on page 8-14](#). For drain valve locations, see [Drain Valves on page 8-14](#)

1. Reconnect all lines and showerheads that were disconnected in the previous steps.
2. Close all the drain valves.
3. Open the sink and shower drains if they are closed.
4. Open all the faucets, including the showerhead faucet handle and, if equipped, the external showerhead.

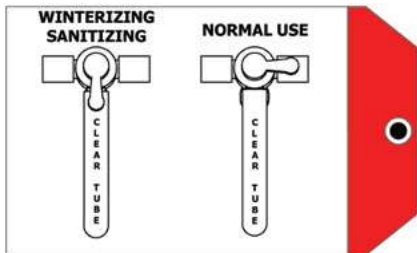

5. Go to the winterization kit and turn the valve handle to the winterizing position as indicated on the tag attached to the kit (shown above).
6. Uncoil the hose attached to the kit, remove the hose cap, and insert the hose down to the bottom of the RV antifreeze container.
7. Turn the pump switch on and run it until antifreeze starts coming out of the faucets. Once antifreeze runs from one tap, turn it off and continue to the next one. Move from one fixture to the next, shutting them off as you go until all the lines are full. As you empty each antifreeze container, turn the pump off, transition to a full container, and turn the pump back on to continue.
8. Allow the antifreeze to flow down drains. Flush the toilet and allow antifreeze to flow down the toilet. If equipped, operate the toilet hand sprayer until antifreeze is coming out. Work the hand shower sprayer while holding it down in the tub until

antifreeze is coming out, and if equipped, do the same with the external showerhead. Any remaining antifreeze can be dumped down a drain.

9. Shut the pump off once all the lines are full.
10. Open all the faucets and leave them open.
11. Turn the winterization kit valve back to the normal use position, place the cap back on the hose, and coil it back up for storage.

NOTICE

Remove all RV antifreeze spillage from all drain and faucet parts after winterizing. Failure to do so could damage the plumbing fixture's finish. Do not use water to rinse antifreeze down the drain as it will dilute the antifreeze.

Restoring Service After Winter

1. Re-install the fully charged batteries.
2. Close the dump valve, all water faucets, and fresh water tank drain.
3. Add water to the fresh water tank.
4. Turn on the water pump.
5. Open and close the faucets one at a time until the water runs clear at all faucets signaling RV non-toxic antifreeze is flushed out of lines. Go back and recheck water clarity at all faucets.
6. Turn off the water pump.
7. Hook up to a city water supply, open the faucets again, and recheck water clarity.

Main Door Care

Lubrication

Apply a little paraffin or grease to the striker pockets and a slight amount of household oil to the lock mechanisms to keep the locks operating smoothly. Also, lubricate the hinge pins periodically with household oil. Use the lubricant sparingly and immediately remove any excess from exterior skin.

Adjustment

Main door adjustment can be affected by:

- The trailer being improperly leveled (causing twisting of trailer body/shell).*
- Striker bolt alignment being out of adjustment, (striker bolt is adjustable).
- Screen door being out of adjustment, resulting in a situation of the door rubbing the frame, or not closing flush (which will create pressure on the door).
- Main door has come open at some point, introducing a change to the contour of the door frame (check for sheared rivets on interior skin of door).

* When using the stabilizers (for eliminating movement-not leveling) on your Airstream, be sure to check the fit of your main door before and after extending stabilizers. The fit of the main door can be affected if trailer is not level side to side and front to back.

Windows

Sticking Windows

Forcing the window open may cause the window to shatter. Always follow the guidelines below for releasing a stuck window.

1. Unlatch the window latches securing the windows on the interior.
2. Apply some 303 Aerospace Protectant to a nylon wedge window tool.
3. Starting in the corner, tuck the end of the nylon tool under the glass and gently slide to opposite end.

⚠ WARNING

Prying up or applying pressure to the window may cause the window to shatter, resulting in personal injury or unit damage.

4. Once the window is released, wash the gasket with a mild soap and water solution, and dry.
5. Apply 303 Aerospace Protectant (Airstream part # 44845WR-01) to the window gasket. To apply, spray/pour 303 onto a soft rag or sponge and apply a generous coating directly to the gasket. Remove any residue that comes in contact with the exterior aluminum skin. This may be ordered through the Airstream dealer or at the Airstream online store at www.airstream.com.

Electrical Diagrams

12-Volt Main Schematic

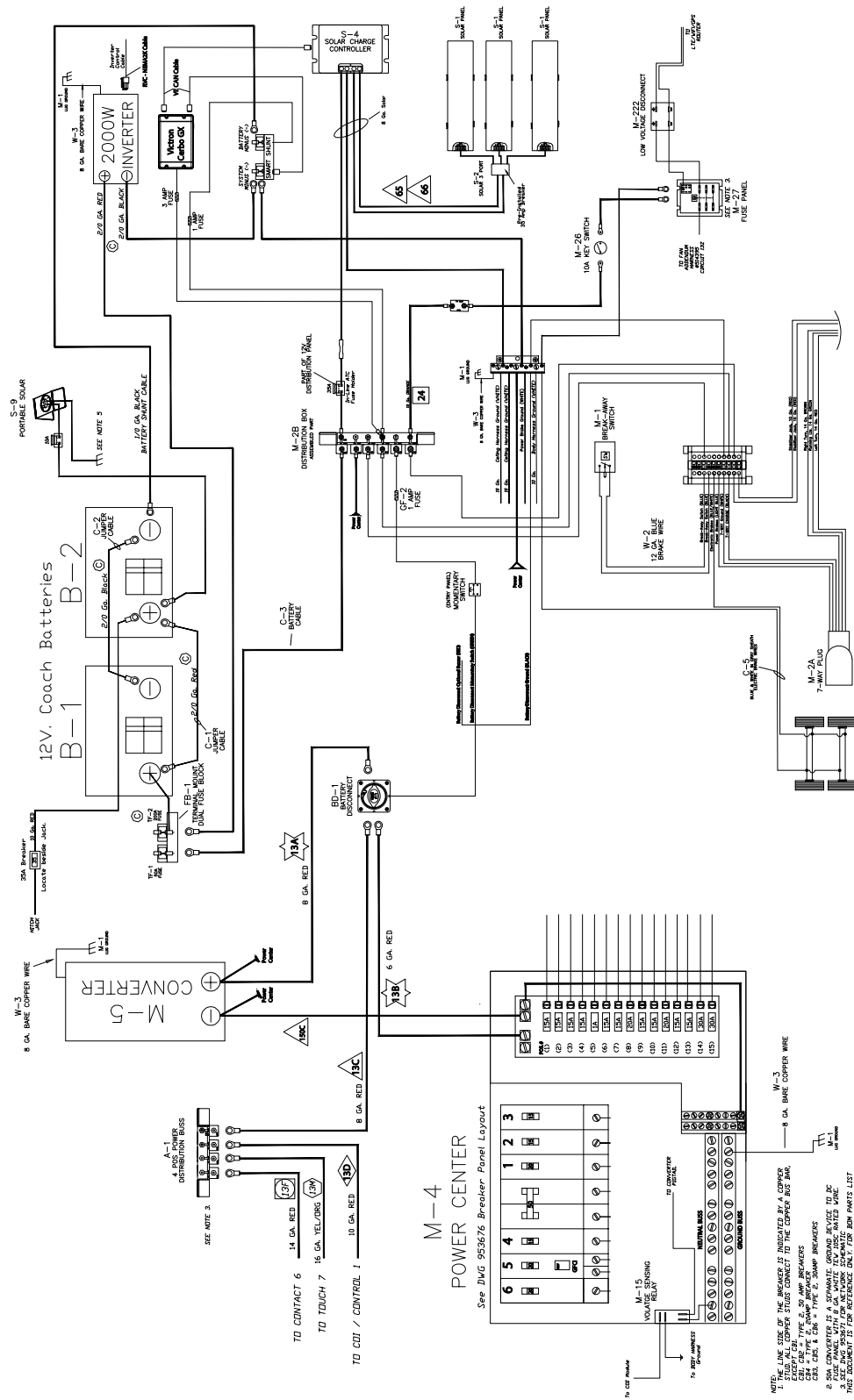

This document and the information contained within are confidential and proprietary to Alstream, Inc. and shall not be copied, distributed or used in whole or in part without express written consent from Alstream, Inc.

- NOTE:
1. THE WIRE SIZE OF THE BREAKER IS INDICATED BY A NUMBER IN THE CIRCLE. KEEP THE WIRE TYPE AS SHOWN IN THE CIRCLE AND DO NOT EXCEED THE 80% TAMP BREAKER RATING.
 2. SOLAR CONVERTER IS A SEPARATE GROUND DEVICE TO BE GROUND WITH A GROUND ROD TO THE BATTERY BANK. SEE DRAWING FOR REFERENCE ONLY. FOR BOM PARTS LIST SEE DRAWING FOR REFERENCE ONLY.
 3. ALL FUSION CONNECTIONS NEED TO BE PROTECTED WITH A GROUND THE PORTABLE SOLAR TO BATTERY CASE.

Maintenance

120-Volt/50-Amp Diagram

The following electrical diagrams are representative of the National Electric Code (NEC) and Canadian Standards Association (CSA). All circuits are NEC with the exception of CSA circuits as specified in each respective table.

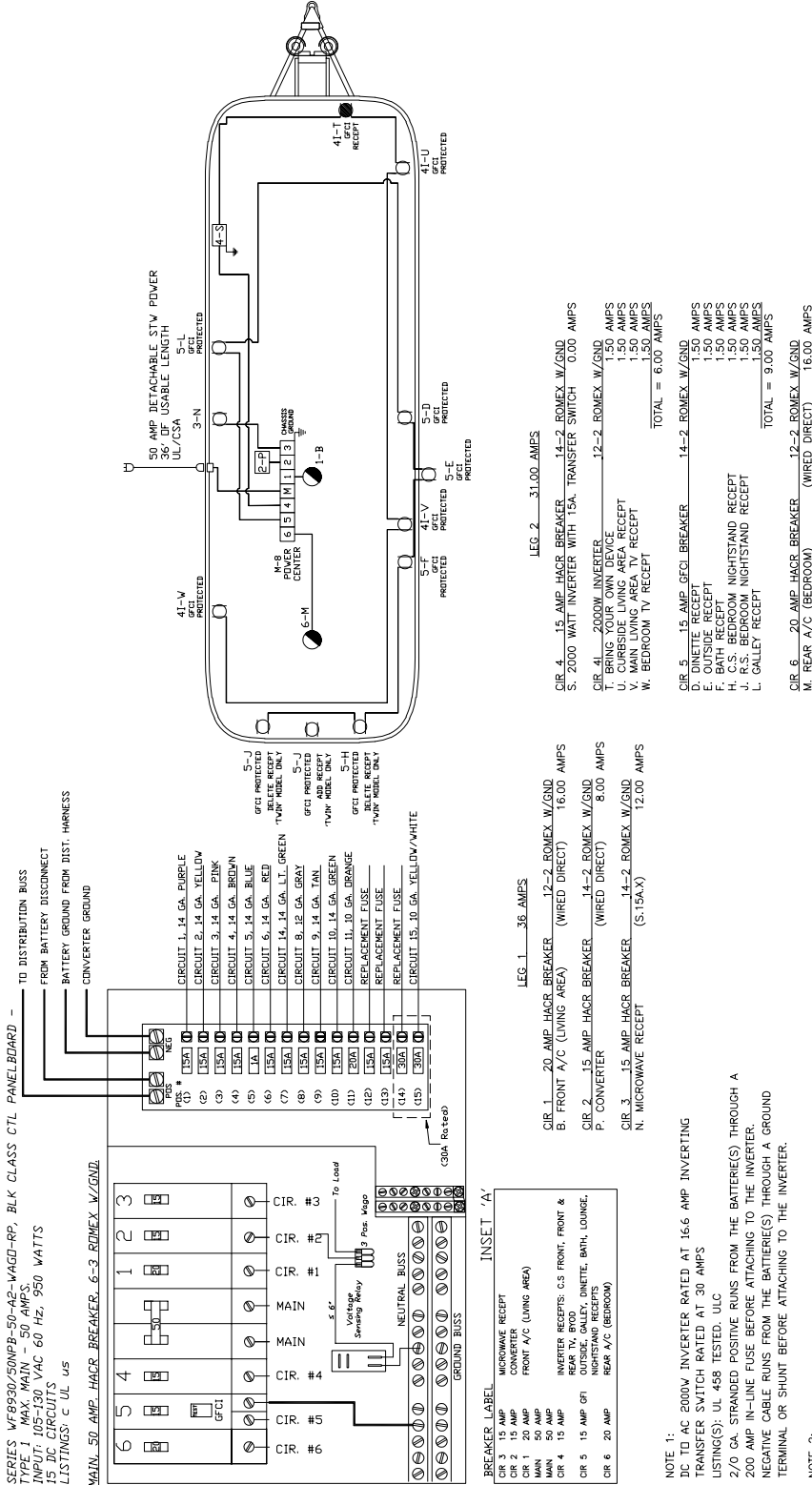

120-Volt/50-Amp Diagram - CSA

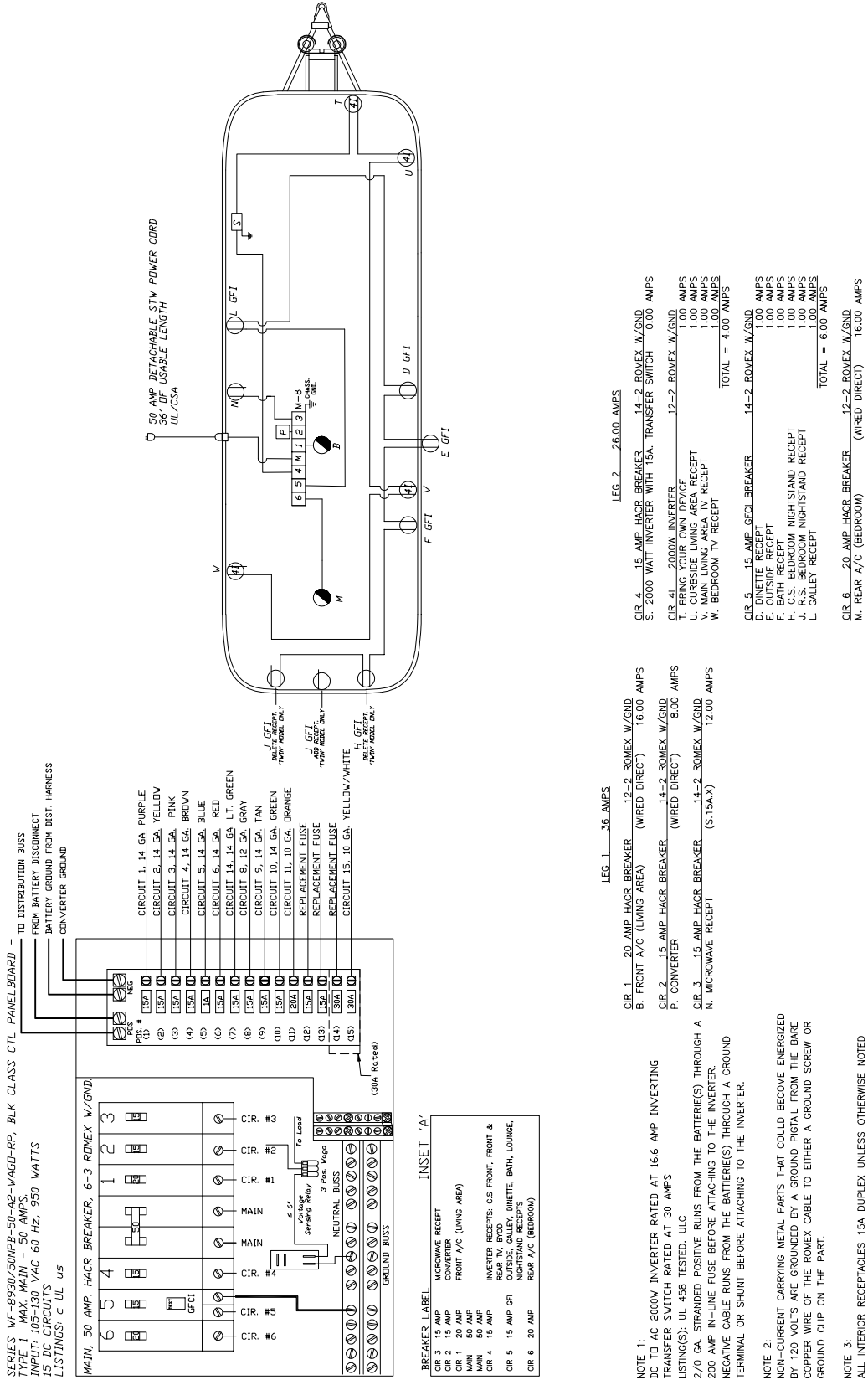

Maintenance

Solar Panel Wiring

Your Airstream comes factory equipped with solar panels on the roof. For your convenience Airstream has also installed a plug for a portable solar panel at the front of the trailer near the battery box. Simply plug the power cord from your portable solar panel into the front port for extra solar power. The solar panel has a charge controller that is mounted close to the battery buss bars, as the battery leads and Cat 5 wire are hooked into it to sense the actual battery charge.

NOTE

The yellow wire is fused with a 35-amp in-line fuse at the 12-volt positive wire.

The following diagram depicts the way Airstream wires the solar system.

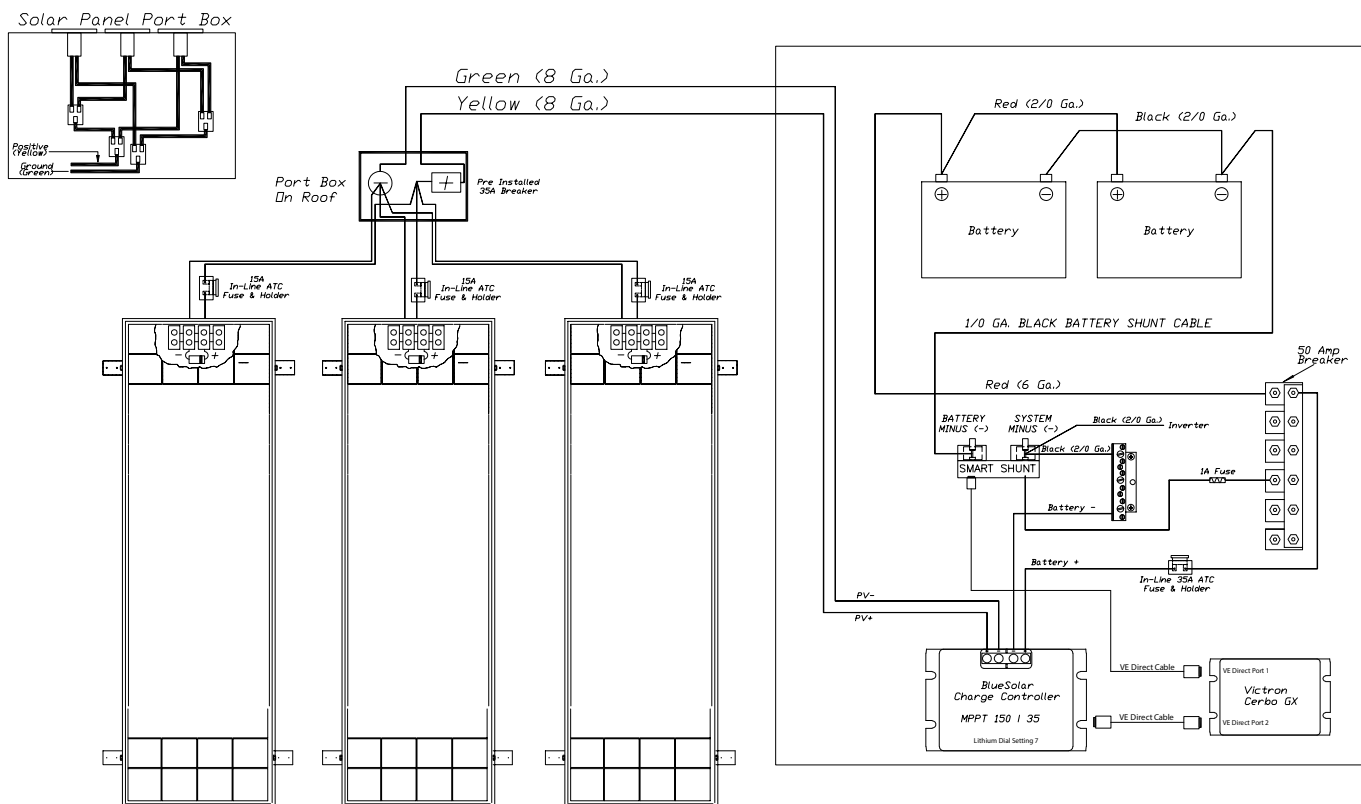

*Solar Grounds to Battery via Ground Buss bar.

Multiplex Controls

Switch Panel Layout

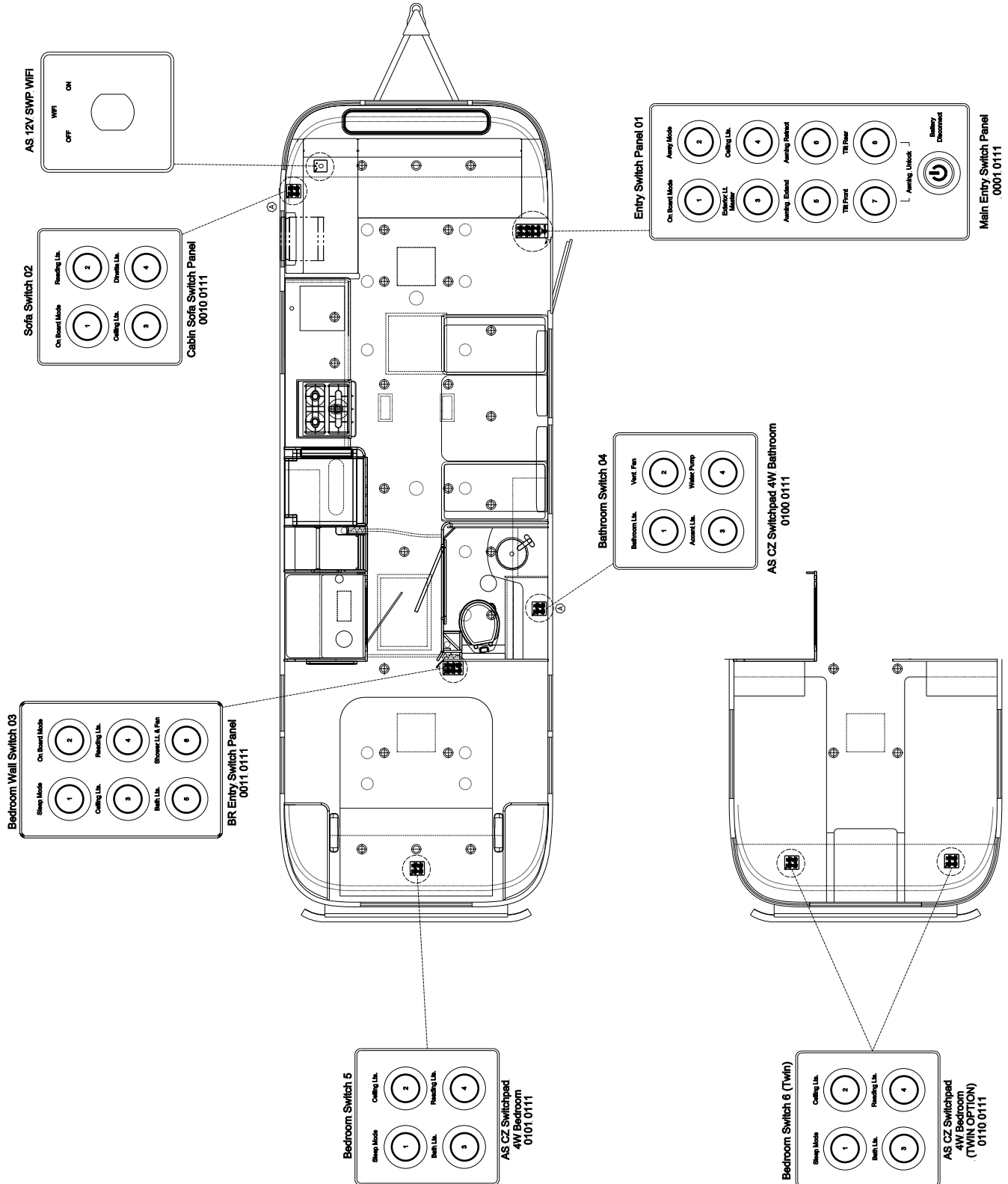

Maintenance

Alarms

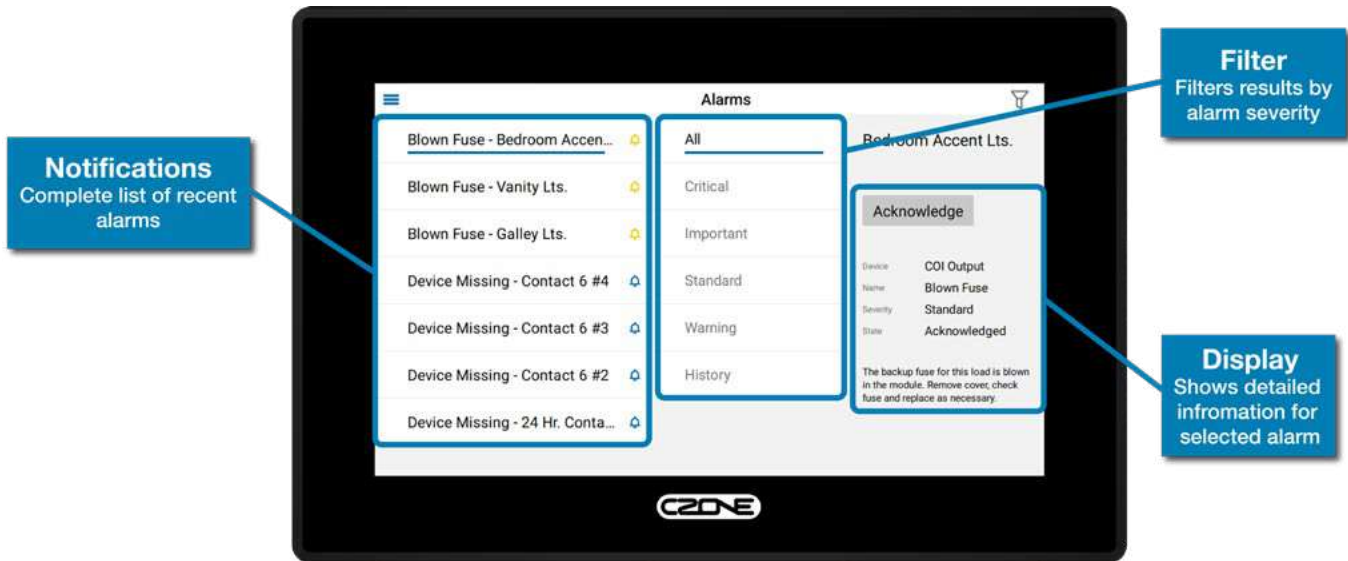

Alarms - Notifications

The Alarms Menu will display a list of the alarms that have been triggered by the CZone® system. Alarm notifications are set at the factory and have four severity levels.



Blue - Warning, this is the lowest alarm severity indicating a minor issue. The alarm will disappear once acknowledged.



Yellow - Standard, will be provided with a popup dialogue on screen. The alarm will disappear once acknowledged.



Orange - Important, indicates something is wrong with a system and you will need to investigate before trying to operate it. This alarm will give you an audible tone and popup dialogue on screen. The alarm will remain active in the alarms page.



Red - Critical, immediate action is necessary to avoid damage and/or a failure of a system. This alarm will give you a popup dialogue and audible tone no matter the screen or action you are currently on. The alarm will return in 10 minutes after acknowledgment until the fault is remedied.

Modes

Modes - Three Preset Modes

Away Mode - Can be used when temporarily away from the travel trailer while camping. Away mode will power OFF most features to help conserve battery power.

On-Board Mode - Provides an easy one touch ability to turn ON most features of the travel trailer.

Sleep Mode - Provides an easy one touch ability to turn OFF most features of the travel trailer.

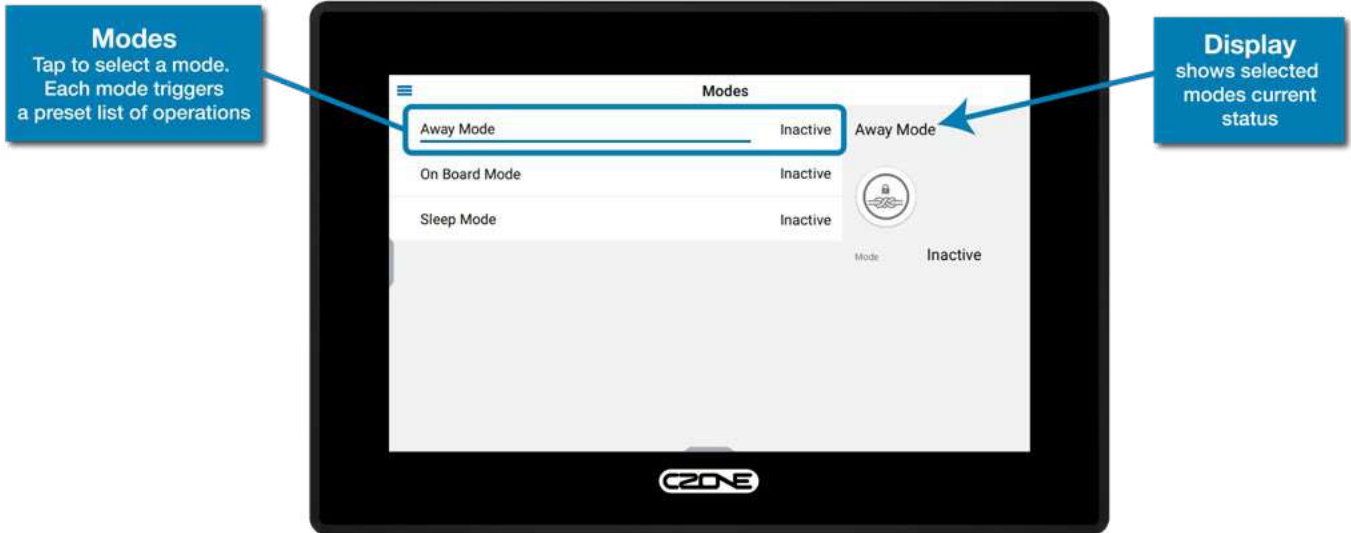

Away Mode

- Ceiling Lights turn ON to 50% for 20 seconds and then OFF
- All other items turn off and Vents close

The battery disconnect does not activate during Away Mode, you will need to disconnect separately

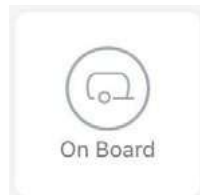

On Board Mode

- Awning Power is ON
- All Backlights turn ON
- Galley, Bedroom Reading, and Ceiling Lights turn ON



Sleep Mode

- Reading Lights turn OFF
- Bath Lights and Fan turn OFF
- Bedroom Ceiling Lights turn OFF
- Backlighting Bathroom Switch Dims to 20%
- Backlight Main Cabin Switch Dims to 20%
- All other Backlighting turns OFF
- Galley Lights turn OFF
- Dinette Lights turns OFF
- Main Ceiling Lights turn OFF
- Shower Light and Fan turn OFF

Maintenance

Settings

The Settings Menu provides access to information such as: About, Configuration, Display and Sound, Units, System, Battery Calibration, NMEA 2000 Monitoring, Wireless Server, Network and Reset.

Airstream recommends against changing any settings except Display and Sound, Temperature and Volume, and Date and Time.

Settings such as Wifi Server, Dipswitch Settings, and Network Address should never be changed and could cause the system to quit operating completely. Changing of CZone® system settings via the touch screen control panel may require the travel trailer to be taken to a service center for reconfiguration.

NOTE

It is important to know that while system settings can be manually changed most should not. Airstream calibrates the system before leaving the factory and any changes made after may cause the system to function incorrectly or not at all.

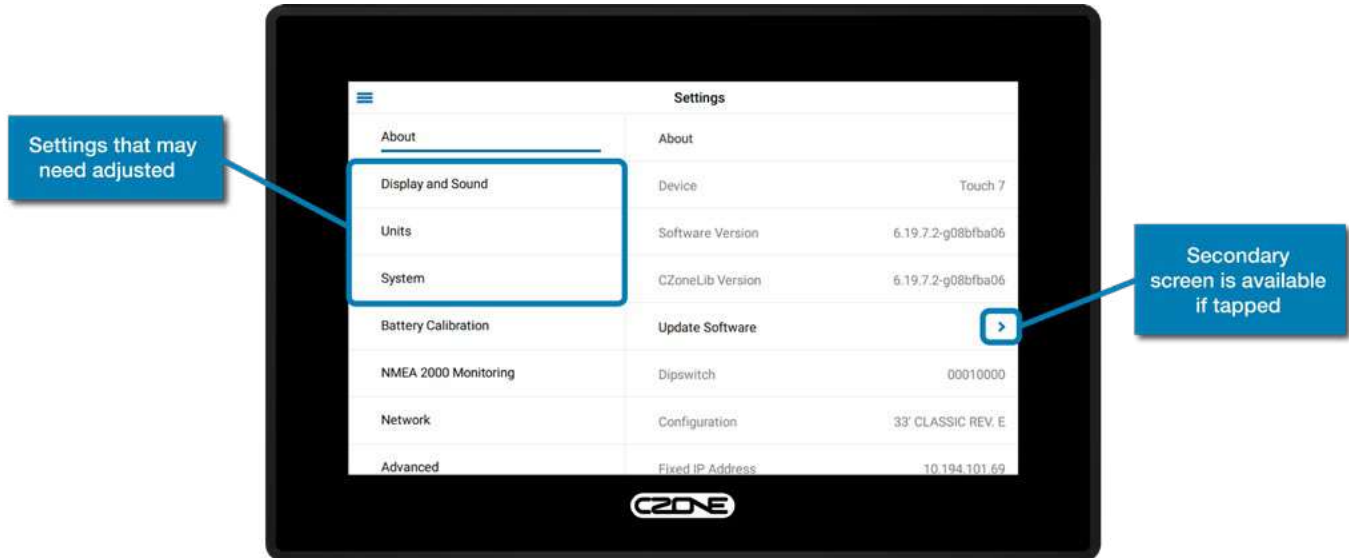

Fresh Water Layout

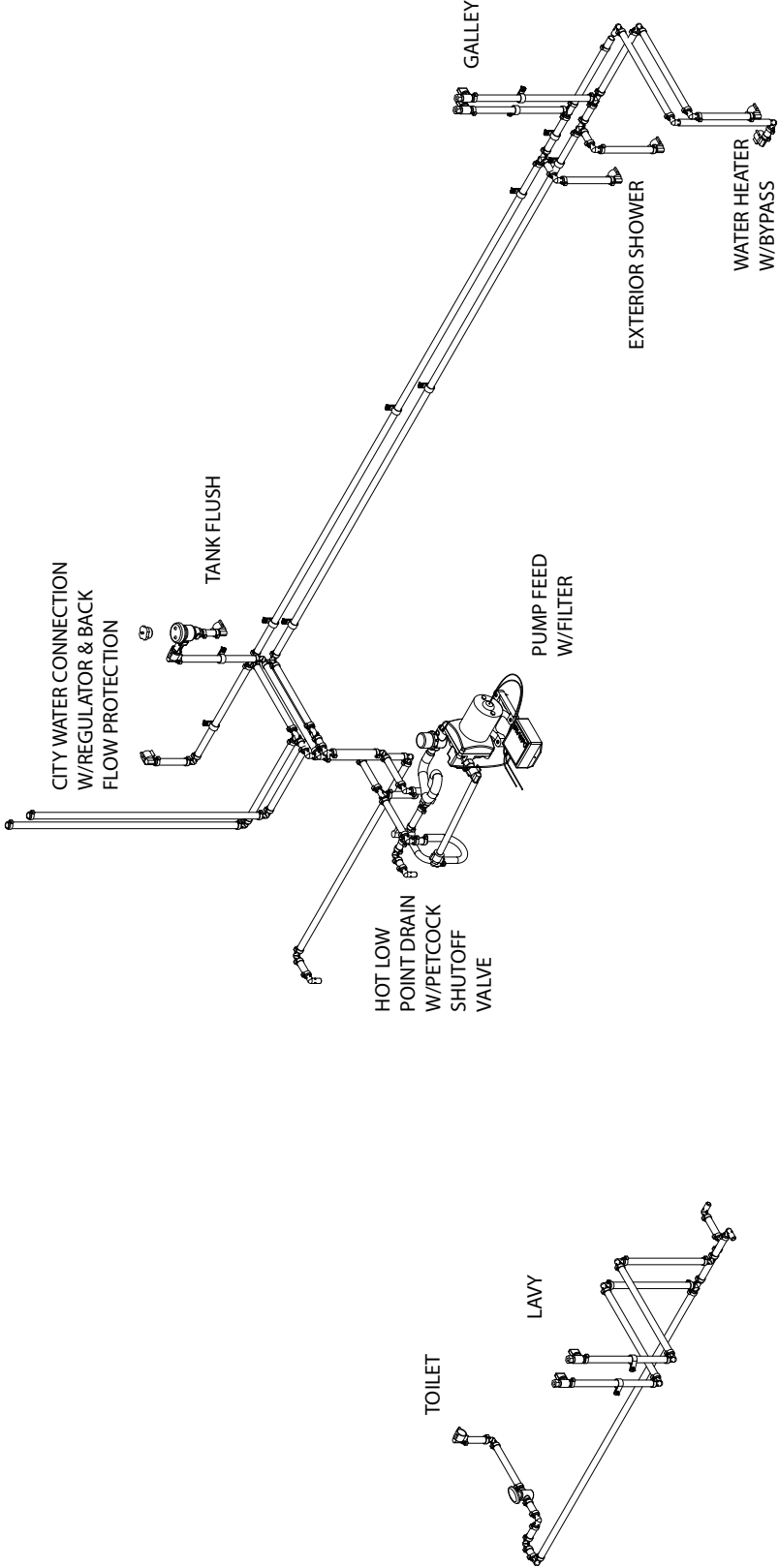

FAQs and Answers

Electrical

1. **What size of generator is needed to operate my Airstream?**

Answer: A 1,000-watt generator may be used to charge just the batteries. However, if you are wanting to run appliances such as microwave or AC units, it is recommended to have at least 4,000 watts or more, which is enough power to run one major appliance. (This is for a 30 amp system).

* Many Airstreamers accomplish this using two portable generators running in parallel.

2. **What can I plug into the 2000 watt inverter outlets in my Airstream?**

Answer: These plugs are designed for no more than 2000 watts of power and are intended for charging things such as laptops and phones, and TV usage. Plugging in items such as vacuums, hair dryers, etc., may harm the system; [see Inverter on page 5-10](#).

3. **What size batteries are in my Airstream?**

Answer: Your Airstream is equipped with two BattleBorn 100Ah 12V LiFePO4 batteries.

4. **Do you recommend using a surge protector when plugged into shore power?**

Answer: Your Airstream is breaker protected. However, with the use of more personal electronic devices and the number of RV users in parks, added protection is always a plus.

5. **What is the battery disconnect switch function?**

Answer: It is a switch that disengages or engages the 12-volt power supply from the house batteries to everything but the LPG detector. The switch is used to cut power when the trailer is not being used or put into storage to preserve battery charge; [see Battery Disconnect Switch on page 5-10](#).

6. **What can I do if the power jack will not function?**

Answer: The jack may be raised and lowered using the hand crank provided. Check for 12V power and proper grounding at the jack. For more information, [see Power Jack on page 6-8](#) and [see Power Jack on page 8-11](#).

7. **What does the power converter do in my trailer?**

Answer: The converter takes 120-volt AC shore power and turns it into 12-volt DC to keep batteries charged and power 12-volt items in your trailer; [see Converter Operation on page 5-11](#).

Appliances

1. *I am planning for a trip in my Airstream. How should I get the refrigerator cooled down?*

Answer: Cooling time will vary with exterior temperatures and time of day. Start by pre-cooling your refrigerator at least 12 hours prior to loading your refrigerator. Always pre-cool food in your refrigerator or freezer to reduce cooling time. Don't pack food too tightly in compartment as to prevent circulation around food items. Normal refrigerator operating temperatures are 34 to 40°F.

2. *My air conditioner freezes up. What is the problem?*

Answer: In high humidity conditions, the AC manufacturer recommends you operate your AC (manual mode) on the high fan setting and all vents should be open to have maximum air flow over the coils; this helps reduce icing. Also, dirty air conditioner filters can restrict air flow and cause the AC to ice up.

Plumbing

1. *While parked at my site, do you recommend leaving my dump valves open?*

Answer: You cannot leave your black water valve open. This would cause a buildup inside the tank. You need to keep this closed until you are full or ready to leave. (Remember, use your no-fuss flush.)

2. *How do I use my black water tank flush?*

Answer: First, empty your black water tank, then close your black water tank valve. Hook up your hose to the external hookup, run a couple minutes, and then open the valve. Do this a couple times until clear; [see Black Water Tank Flush on page 8-15](#).

3. *Do I need a water regulator?*

Answer: No, your Airstream is equipped with a built in regulator rated for 50 psi.

4. *How do I get fresh water into my trailer?*

Answer: You can use the on board fresh water tank and 12-volt pump for your water supply when boon docking, or hook to an external water source via non-toxic water hose to exterior water inlet when parked at a campground; [see Gravity Water Fill on page 6-6](#) and [see City Water Hookup on page 6-6](#).

5. *What is the difference between a gray water tank and the black tank?*

Answer: The gray water tank holds water from shower and sink drains. The black water tank holds sewer water from the toilet.

Audio-Video

1. *My TV reception is poor. What can I check?*

Answer: Verify your antenna booster is set to proper selection (On- for antenna and Off- for cable satellite). You should also make sure connections are tight on your TV; [see TV/Radio Antenna on page 5-15](#).

Smart RV Connectivity

1. *My mobile device cannot find the router*

Answer: Locate the Key in the front roof locker and ensure that it is turned "on". If "on", reset router by turning the key to the "off" position and then back "on" after 30 seconds

2. *I forgot to write down my network name and password*

Answer: Within the Airstream Smart RV Control app, press the "more" tab then press "Network Settings" the app will display the primary network name, password and allow you to setup a guest network.

See quickstart and app for more FAQ's and instructions on using Smart RV Controls.

Maintenance

1. *Where can I find my trailer serial number?*

Answer: A label is attached on the roadside sheet at the front side sheet seam. This label will also provide the inflation pressure of the tires and GVWR. The serial number of the trailer is also stamped on the street side of the A frame by the LPG tanks.

2. *Awning suggestions:*

Your Zip Dee awning is intended to provide shade. Your awning can be used in light rain conditions if front or rear is tilted to let water run off. Light winds should not affect awning use. If you are leaving your trailer for long periods or in threatening weather, the awning should be retracted. Visit <https://support.airstream.com> to view User Guide Videos on this subject.

3. *Cleaning the exterior of my Airstream. Suggestions:*

Airstream recommends washing the trailer using a mild auto detergent safe for clear coated surfaces. Airstream also recommends waxing a minimum of twice a year. Walbernize Superseal is a product that was designed specifically for Airstream and provides good wax protection; see [Cleaning on page 6-2](#).

4. *Can I use a nylon cover for my Airstream?*

Answer: Airstream does not recommend using any type of cover. The installation and movement of the cover in windy conditions could scratch the clearcoat.

5. *What type of attachments can I install on the rear of my Airstream?*

Answer: Airstream only recommends the installation of a Fiamma bike rack (Airstream part number: 209397) on the rear of trailers.

6. *My main door is hard to open, is this normal?*

Answer: Your main door is designed differently than a flat surface door. The door is over bent in order to apply more pressure at the top and bottom of door for better sealing. Also, on uneven surfaces, the trailer can be in a slight twist that could affect closing. Make sure trailer is as level as possible. For more information, see [Main Door Care on page 8-18](#).

7. *What is a rubber torsion axle?*

Answer: Your trailer has Dexter rubber torsion axles. This type axle has internal rubber cords that provide load carrying capacity verses leaf spring type axles. Reminder - never jack up trailer using rubber torsion axle tubes; see [Axle and Running Gear Assembly on page 6-7](#).

8. *My windows are sticking and don't open easily; what is wrong?*

Answer: Your windows have rubber seals around the edges which in extreme heat and dusty conditions can become sticky. You can help prevent this by regularly cleaning window seals with soapy water and applying a silicone product or Aerospace Protectant 303 to the seals. For more information, see [Windows on page 6-2](#).

9. *The mattress in my Airstream is an odd shape, where can I buy sheets?*

Answer: Airstream has a selection of sheets for your Airstream and can be purchased by calling (937) 596-6111 extension 7400 or 7418. You can also access our store website at <https://www.airstreamsupplycompany.com>.

Index

A

Air Conditioner 5-18
Airstream Academy ii
Airstream Connected, Wi-Fi 5-16
Alarms 2-3
Aluminum Wheels 6-2
Appliances 5-18
Awning 6-4

B

Battery 5-7, 5-21, 8-12
Battery Disconnect Switch 5-10
Bed Conversion 5-5
Black/Gray Tank 3-10
 Black/Gray Water Tank and
 Draining 8-15
 Drain Systems Cleaning 8-15
Brakes 7-2, 8-10
 Electronic Brake Controller 7-2
 Proper Electric Brake Use 7-2
Breakaway Switch 7-3, 8-11

C

Cable/Satellite Connection 5-15
Camber 8-10
Camping 3-7
 Effects Of Prolonged Occupancy
 3-9
 Extended Stay 3-8
 Pre-Travel Check List 3-7
Carbon Monoxide 2-4
 Detector 2-4
 Important Safety Precautions 2-5
 Symptoms of Carbon Monoxide
 Poisoning 2-6
Ceiling Vent Fan 5-19
Chemical Sensitivity 2-2
Circuit Breakers 8-3
 Breaker Test 5-13
City Power 5-12
City Water Hookup 6-6
Cleaning
 Exterior 6-2
 Interior 5-3
Converter 5-12
 Converter Operation 5-11
Cooktop 5-19
Cordset 6-7

D

Detectors 2-3
Dinette Table and Bed Conversion
5-5
Door
 Lubrication and Adjustment 8-18
 Main Door 6-3
 Screen Door 6-3
Doormat and Rug Selection 5-4
Drain and Waste System 5-6
Drain Systems Cleaning 8-15
Drain Valves 8-14

E

Electrical 5-7
 7-Way Plug 7-5
 12-Volt Power Circuits 5-11
 12-Volt System Information 5-7
 City Power 5-12
 Shoreline Power Supply 6-7
Electrical Diagrams 8-19
Emergency Escape Windows 6-3
Ethernet Inlet 6-6
Exhaust Fans 5-19
Exhaust Vent 5-20

F

Fan 5-19
FAQs and Answers 8-28
Faucets 5-7
Filters 8-4
Fire Extinguisher 2-7
Flooring 5-4
Floor Plans 4-2
Formaldehyde 2-3
Freeze Damage Protection 3-11
Fresh Water Layout 8-27
Fresh Water Tank Draining 8-14
Front End Protection 6-4
Fuses 8-3
Fuses and Breakers 5-7

G

Gas Regulator 6-10
GFCI 5-13
Gravity Water Fill 6-6

H

HDMI/Ethernet wall port 5-14
Hitch
 7-Way Plug 7-5
 Hitching Up 7-4
 Measuring Hitch Ball Height 4-4
Hitch/Coupler 6-7

I

Inverter 5-10

J

Jack 3-9
 Power Jack 6-8, 8-11
 Stabilizing Jacks 3-9
 Tire Changing 8-5
Jack Locations 8-5

L

Leveling 3-8
License Plate LED 8-3
Lighting 5-9, 8-3
Liquid Petroleum Gas 6-9
 Detector 2-4
 Detector Test 2-4
 Low Voltage 2-4
Load Distribution
 Equalizing 7-5
Loading 7-3
LPG 2-4, 3-8, 5-18, 6-9, 6-10,
6-11, 8-28, 8-30
 Basic Rules For LPG Safety 2-6
 Detector 2-4
 Fill Valve 6-9
 Port 6-11
 Safety 2-6, 6-11
 Tanks 6-10
LPG Port 6-11
Lug Nut Torquing 2-2, 8-9
Lug-Pattern Sequence 8-9

M

Main Door 6-3, 8-2
 Lubrication and Adjustment 8-18
Maintenance Schedule 8-2
Micro-Controller Operation 5-11
Microwave 5-21
Mold 2-2, 3-10, 3-11
Monitor Panel 5-21

Index

- O**
 - Outlets 5-10
 - 120-Volt Outlet 6-6
 - Overnight Stop 3-8
- P**
 - Parts 8-3
 - Plumbing 5-5
 - Power 5-12
 - Power Center 5-10
 - Power Head
 - Maintenance 8-11
 - Power Inlet and Cordset 6-7
 - Power Jack 6-8, 8-11
- R**
 - Refrigerator 5-22
 - Restoring Service After Winter 8-17
 - Roadside Assistance 3-6
 - Rug Selection 5-4
- S**
 - Safety 2-2, 2-7
 - Controlling Sway, Fishtailing 7-8
 - Sanitizing 8-14
 - Satellite Connection 5-15
 - Screen Door 6-3
 - Service 3-6
 - Shell Protection 6-4
 - Shoreline Power Supply 6-7
 - Shower, Exterior 6-6
 - Shower, Interior 5-4
 - SmartPlug Cordset 6-7
 - SmartPlug Inlet 6-7
 - Smoke Alarm 2-3
 - Solar Panel Wiring 8-22
 - Solar System 5-22
 - Spare Tire Carrier 8-9
 - Specifications 4-3
 - Stabilizing Jacks 6-8
 - Step 6-3
 - Stereo 5-14
 - Stone Guards 6-4
 - Sway Control Device 7-8
- T**
 - Table and Bed Conversion 5-5
 - Tanks 8-14
 - Black/Gray Water Tank Draining 8-15
 - Drain Systems Cleaning 8-15
 - Fresh Water Tanks and Draining 8-14
 - Thermostat 5-19
 - Tires 8-5
 - Tire Changing 8-5
 - Toe-In 8-10
 - Toilet 5-6
 - Touch-up 8-4
 - Towing 2-2
 - 7-Way Plug 7-5
 - Backing Up 7-7
 - General Information 7-5
 - Tow Vehicle 7-2
 - Trailer
 - Weight 7-4
 - TV and Audio Component Pairing 5-14
 - TV/Radio Antenna 5-15
- U**
 - Upholstery 5-3
 - User Guide Videos ii
- V**
 - Vent 5-19, 5-20
 - Ceiling Vent Fan 5-19
 - Exhaust Vent 5-20
 - Ventilation 2-2, 2-3
 - Vinyl Flooring 5-4
- W**
 - Warranty 3-2
 - Obtaining Warranty Service 3-4
 - Waste Water System 3-10
 - Water Fill 6-6
 - Water Heater 5-23
 - Water Heater Draining 8-14
 - Water Pump 5-5
 - Access Locations 8-14
 - Strainer Cleaning 8-14
 - Water System 5-5
 - Weighing Your Trailer 7-4
 - Weight Distribution 2-2
 - Wheel Bearing Maintenance 8-9
 - Wi-Fi 5-16
 - Windows 6-2
 - Window Stone Guards 6-4
 - Winterizing and Storage 8-16
 - Winter Traveling 3-11

AIRSTREAM®

1001 West Pike Street

P.O. Box 629

Jackson Center, OH. 45334-0629

Phone: (937) 596-6111 Fax: (937) 596-7939

www.airstream.com